

KAPAKLI CEPHE
COVER FACADE

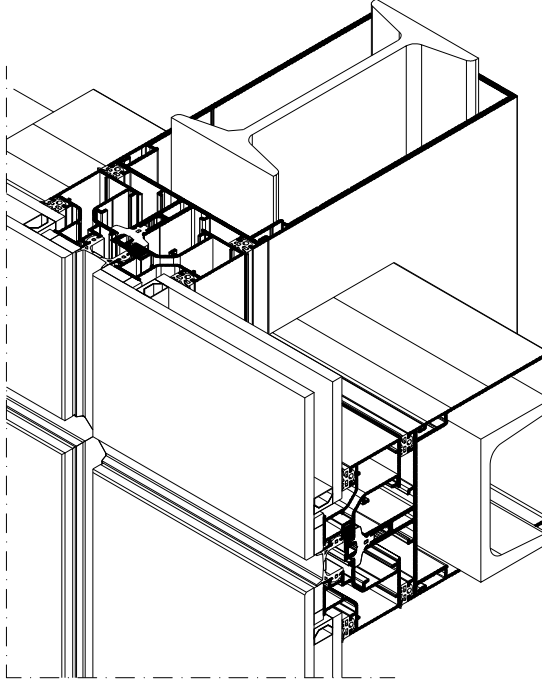









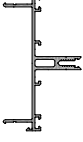

SİLİKON CEPHE
SILICONE FACADE

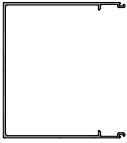
ÇT94
ÇELİK TAKVİYELİ CEPHE
STEEL REINFORCED FACADE

ÇT94
ÇELİK TAKVİYELİ CEPHE
STEEL REINFORCED FACADE

ÜRÜN TEKNİK ÖZELLİKLERİ
PRODUCT'S TECHNICAL FEATURES





No. Nr.	PROFİL KESİTİ PROFILE VIEW		PROFİL AÇIKLAMASI PROFILE DESCRIPTION	BAĞLANTI PARÇALARI CORNER CLEATS		STATİK STATIC			
						I_x cm ⁴	I_y cm ⁴	W_x cm ³	W_y cm ³
1		ÇT94-101 (53,8 - 94) (2 mm)	TAŞIYICI PROFİL MULLION OR TRANSOM PROFILE		1267				
2	  İşaretili profil için satış ekibinden bilgi alınız.	ÇT94-201 (38 - 49,5) (13 mm)	ÇİFT CAM PANEL PROFİLİ PANEL PROFILE FOR DOUBLE GLASS	SC0308-a (25,68 mm) SC0307-a (10,25 mm) SC0304-a (50 mm)	796				
3		ÇT94-301 (91 - 9) (2 mm)	BASKI PROFİLİ PRESSURE PROFILE	ÇT94-302	788				
4		ÇT94-302 (20 - 94) (15 mm)	KAPAK PROFİLİ COVER PROFILE	ÇT94-301	587				
5		ÇT94-303 (84,6 - 94) (16 mm)	KAPAK PROFİLİ COVER PROFILE	ÇT94-101	1139				
6		ÇT94-304 (164,6 - 94) (2,8 mm)	KAPAK PROFİLİ COVER PROFILE	ÇT94-101	3078				
7		SCO201 (34,9 - 49,5) (13 mm)	ÇİFT CAM PANEL PROFİLİ PANEL PROFILE FOR DOUBLE GLASS	SC0308-a (25,68 mm) SC0307-a (10,25 mm) SC0304-a (50 mm)	734				
8		SCO204 (34,9 - 59,6) (13 mm)	ÇİFT CAM PANEL PROFİLİ PANEL PROFILE FOR DOUBLE GLASS	SC0308-b (29,74 mm) SC0309-a (6,5 mm) SC0304-a (50 mm)	PVC 970 POLYAMİD 963				
9		SCO207 (19,1 - 4,9) (15 mm)	SİLİKON YAPIŞTIRMA PR. SILICONE BONDING PROFILE		109				
10		SCO210 (36,1 - 50,5) (2 mm)	ÇİFT CAM PANEL PROFİLİ PANEL PROFILE FOR DOUBLE GLASS	SC0308-a (25,68 mm) SC0307-a (10,25 mm) SC0304-a (50 mm)	1001				

Profil değerleri teoriktir. Ağırlık olarak testimde yapılan tartım geçerlidir.
Profil imalatları TS EN 12020-2 ve TS EN 755-9 toleransları,
Moment değerleri EN 14024'e göre hesaplanmıştır.

Profile values are theoretical pre-shipment weight will be valid.
The tolerances of Profile manufacturing are calculated according to EN 12020-2
and TS EN 755-9; moment values are calculated according to EN 14024.

ÇT94
ÇELİK TAKVİYELİ CEPHE
STEEL REINFORCED FACADE

ÜRÜN TEKNİK ÖZELLİKLERİ
PRODUCT'S TECHNICAL FEATURES

No. Nr.	PROFİL KESİTİ PROFILE VIEW	PROFİL NO PROFILE NO	PROFİL AÇIKLAMASI PROFILE DESCRIPTION	BAĞLANTI PARÇALARI CORNER CLEATS	gr/m	STATİK STATIC			
						Ix cm ⁴	Iy cm ⁴	Wx cm ³	Wy cm ³
11		SC0214 (36.1 - 61.1) (2 mm)	ÇİFT CAM PANEL PROFİLİ PANEL PROFILE FOR DOUBLE GLASS	SC0308-b (29,74 mm) SC0309-a (6,5 mm) SC0304-a (50 mm)	PVC 1275 POLYAMID 1268				
12		SC0215 (33.2 - 73.1) (2 mm)	ÇİFT CAM PANEL PROFİLİ PANEL PROFILE FOR DOUBLE GLASS	SC0308-b (29,74 mm) SC0309-a (6,5 mm) SC0304-a (50 mm)	PVC 1365 POLYAMID 1350				
13		SC0216 (32 - 71.6) (13 mm)	TEK CAM PANEL PROFİLİ PANEL PROFILE FOR SINGLE GLASS	SC0308-b (29,74 mm) SC0309-a (6,5 mm) SC0304-a (50 mm)	PVC 1060 POLYAMID 1045				
14		SC0218 (33.5 - 64.5) (13 mm)	ÇİFT CAM PANEL PROFİLİ PANEL PROFILE FOR DOUBLE GLASS	SC0308-b (29,74 mm) SC0308-g (19,5 mm) SC0304-a (50 mm)	1250				
15		SC0219 (33.5 - 64.5) (2 mm)	ÇİFT CAM PANEL PROFİLİ PANEL PROFILE FOR DOUBLE GLASS	SC0308-b (29,74 mm) SC0308-l (5,6 mm) SC0304-a (50 mm)	PVC 1449 POLYAMID 1442				
16		SC0307 (55 - 55) (9.71 mm)	KÖŞE BİRLEŞTİRME PROFİLİ CORNER CLEATS PROFILE		2140				
17		SC0308 (70 - 70) (11.82 mm)	KÖŞE BİRLEŞTİRME PROFİLİ CORNER CLEATS PROFILE		2392				
18		SC0309 (55 - 55) (6.9 mm)	KÖŞE BİRLEŞTİRME PROFİLİ CORNER CLEATS PROFILE		1636				
19		SC0312 (25.1 - 4.2) (2 mm)	CAM OTURTMA PROFİLİ GLAZING SUPPORT FOR SASH PROFILE		147				
20		SC0350 (23.2 - 6.7) (12 mm)	CAM OTURTMA PROFİLİ GLAZING SUPPORT FOR SASH PROFILE		140				

Profil değerleri teoriktir. Ağırlık olarak testimde yapılan tartım geçerlidir.
Profil imalatları TS EN 12020-2 ve TS EN 755-9 toleransı,
Moment değerleri EN 14024'e göre hesaplanmıştır.

Profile values are theoretical pre-shipment weight will be valid.
The tolerances of Profile manufacturing are calculated according to EN 12020-2
and TS EN 755-9; moment values are calculated according to EN 14024.

ÇT94
ÇELİK TAKVİYELİ CEPHE
STEEL REINFORCED FACADE

ÜRÜN TEKNİK ÖZELLİKLERİ
PRODUCT'S TECHNICAL FEATURES



No. Nr.	PROFİL KESİTİ PROFILE VIEW	PROFİL NO PROFILE NO	PROFİL AÇIKLAMASI PROFILE DESCRIPTION	BAĞLANTI PARÇALARI CORNER CLEATS	gr/m	STATİK STATIC			
						Ix cm ⁴	Iy cm ⁴	Wx cm ³	Wy cm ³
21		KC0201 (54.6 - 59) (13 mm)	SAKLI KANAT KASA PR. OUTER FRAME PROFILE	SC0307-b (27 mm) SC0309-b (8,55 mm)	737				
22		KC0202 (53.2 - 70.6) (13 mm)	SAKLI KANAT KASA PR. OUTER FRAME PROFILE	SC0309-c (18,9 mm)	792				
23		KC0203 (46.9 - 53.9) (13 mm)	SAKLI KANAT KASA PR. OUTER FRAME PROFILE	SC0309-c (18,9 mm)	662				
24		KC0204 (59.5 - 81.3) (2,0 mm)	SAKLI KANAT KASA PR. OUTER FRAME PROFILE	SC0308-h (9,9 mm) SC0309-j (52,8 mm)	1463				
25		KC0331 (20 - 11) (12 mm)	TEK CAM ADAPTÖRÜ PR. SINGLE GLAZING ADAPTER PROFILE		209				
26		KC0332 (22 - 11) (12 mm)	TEK CAM ADAPTÖRÜ PR. SINGLE GLAZING ADAPTER PROFILE		222				
27		KC0333 (16 - 11) (12 mm)	TEK CAM ADAPTÖRÜ PR. SINGLE GLAZING ADAPTER PROFILE		183				
28		KC0334 (18 - 11) (12 mm)	TEK CAM ADAPTÖRÜ PR. SINGLE GLAZING ADAPTER PROFILE		196				
29		KC0336 (33,2 - 9.4) (2 mm)	TEK CAM ADAPTÖRÜ PR. SINGLE GLAZING ADAPTER PROFILE		305				
30		KC0350 (6 - 11) (1 mm)	TEK CAM ADAPTÖRÜ PR. SINGLE GLAZING ADAPTER PROFILE		96				

Profil değerleri teoriktir. Ağırlık olarak testimde yapılan tartım geçerlidir.
Profil imalatları TS EN 12020-2 ve TS EN 755-9 toleransı,
Moment değerleri EN 14024'e göre hesaplanmıştır.

Profile values are theoretical pre-shipment weight will be valid.
The tolerances of Profile manufacturing are calculated according to EN 12020-2
and TS EN 755-9; moment values are calculated according to EN 14024.

ÇT94
ÇELİK TAKVİYELİ CEPHE
STEEL REINFORCED FACADE

ÜRÜN TEKNİK ÖZELLİKLERİ
PRODUCT'S TECHNICAL FEATURES

No. Nr.	PROFİL KESİTİ PROFILE VIEW	PROFİL NO PROFILE NO	PROFİL AÇIKLAMASI PROFILE DESCRIPTION	BAĞLANTI PARÇALARI CORNER CLEATS	gr/m	STATİK STATIC			
						Ix cm ⁴	Iy cm ⁴	Wx cm ³	Wy cm ³
31		KC0351 (14 - 11) (12 mm)	TEK CAM ADAPTÖRÜ PR. SINGLE GLAZING ADAPTER PROFILE		154				
32	  İşaretili profil için satış ekibinden bilgi alınız.	KC0352 (30 - 11) (12 mm)	TEK CAM ADAPTÖRÜ PR. SINGLE GLAZING ADAPTER PROFILE		274				
33		KC0347 (24 - 11) (12 mm)	TEK CAM ADAPTÖRÜ PR. SINGLE GLAZING ADAPTER PROFILE		235				
34		SC0303 (4,4 - 19,5) (15 mm)	TİJ PROFİLİ PUSHING ROD PROFILE		96				
35		SC0304 (19 - 7,6) (28 mm)	DIŞTAN BAĞLANTI PROFİLİ OUTSIDE CONNECTION PROFILE		238				
36									
37									
38									
39									
40									

Profil değerleri teoriktir. Ağırlık olarak testimde yapılan tartım geçerlidir.
Profil imatları TS EN 12020-2 ve TS EN 755-9 toleransı,
Moment değerleri EN 14024'e göre hesaplanmıştır.

Profile values are theoretical pre-shipment weight will be valid.
The tolerances of Profile manufacturing are calculated according to EN 12020-2
and TS EN 755-9; moment values are calculated according to EN 14024.

ÇT94
ÇELİK TAKVİYELİ CEPHE
STEEL REINFORCED FACADE

ÜRÜN TEKNİK ÖZELLİKLERİ
PRODUCT'S TECHNICAL FEATURES

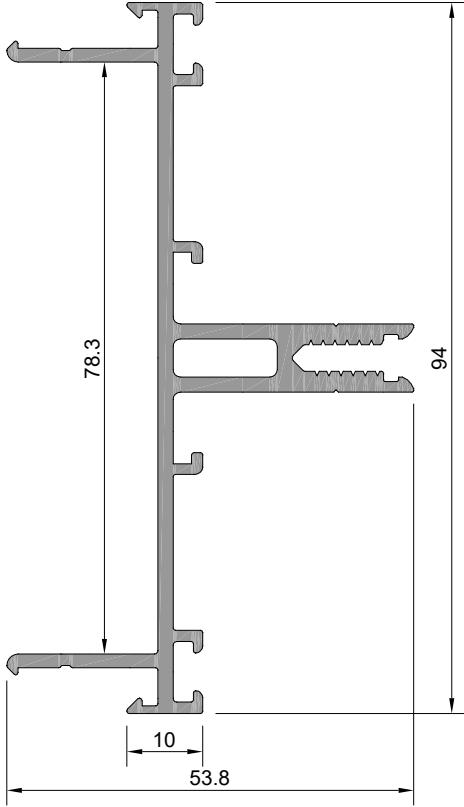

Profil No : ÇT94-101
Ağırlık : 1267 gr/m

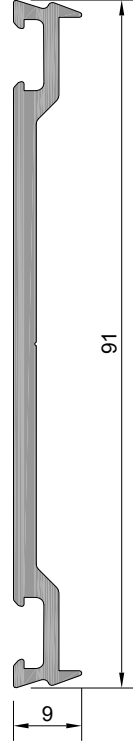

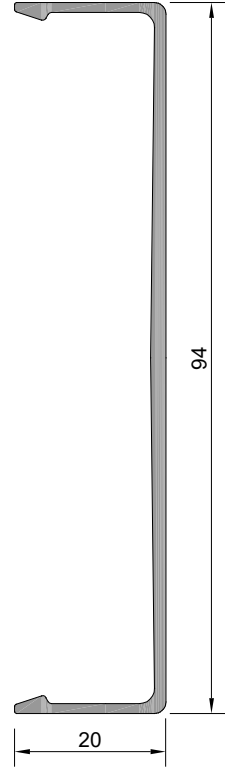

Profil No : ÇT94-301
Ağırlık : 788 gr/m

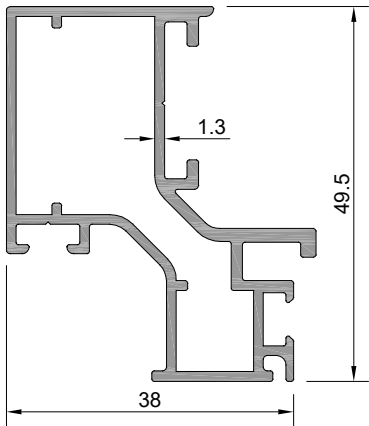

Profil No : ÇT94-302
Ağırlık : 587 gr/m



Profil No : ÇT94-201 
Ağırlık : 796 gr/m
 İşaretli profil için satış ekibinden bilgi alınır.



SC0308-a

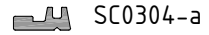

SC0304-a



SC0307-a

ÇT94
ÇELİK TAKVİYELİ CEPHE
STEEL REINFORCED FACADE

ÜRÜN TEKNİK ÖZELLİKLERİ
PRODUCT'S TECHNICAL FEATURES

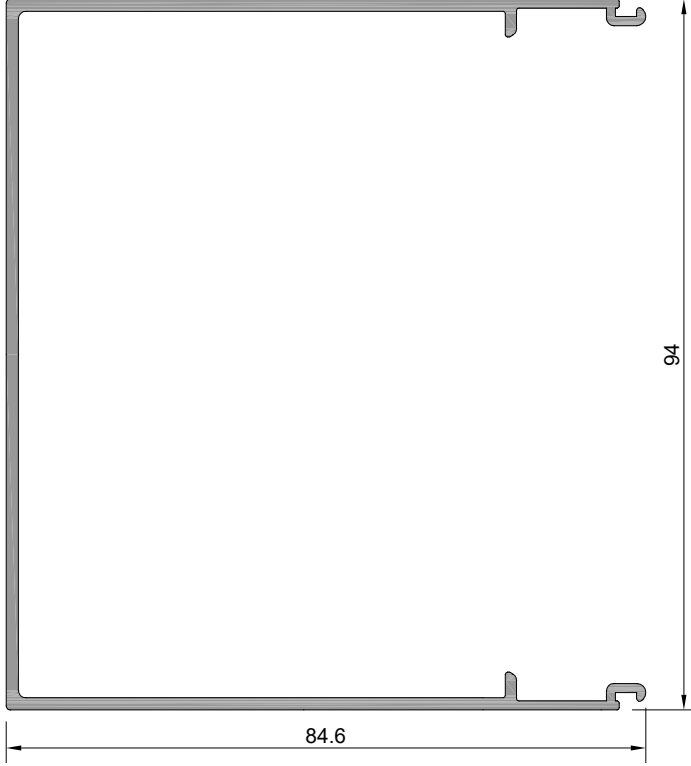

Profil No : ÇT94-303

Ağırlık : 1139 gr/m

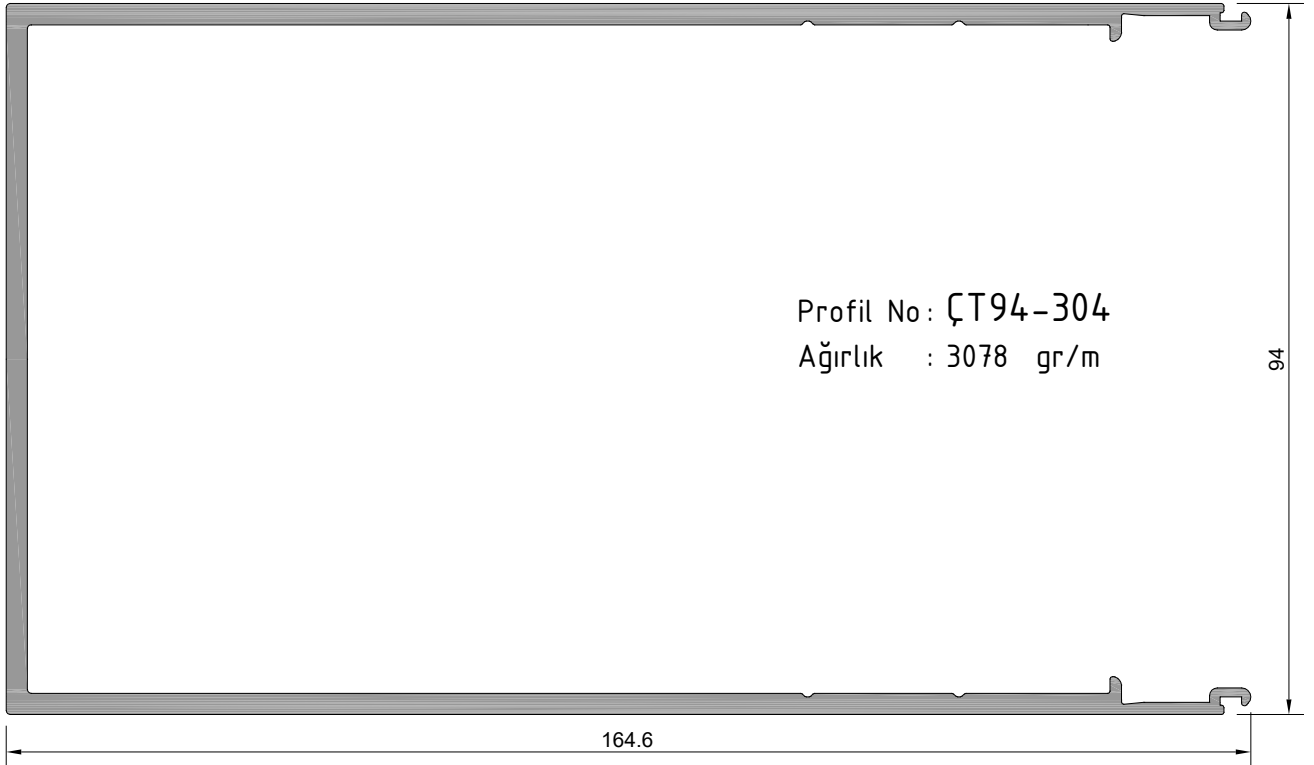

Profil No : ÇT94-304

Ağırlık : 3078 gr/m

ÇT94
ÇELİK TAKVİYELİ CEPHE
STEEL REINFORCED FACADE

ÜRÜN TEKNİK ÖZELLİKLERİ
PRODUCT'S TECHNICAL FEATURES

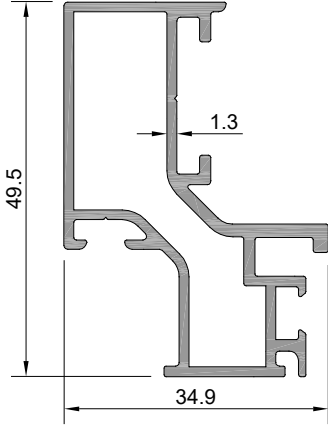

Profil No: SC0201
Ağırlık : 734 gr/m



SC0308-a

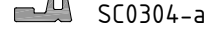

SC0304-a



SC0307-a

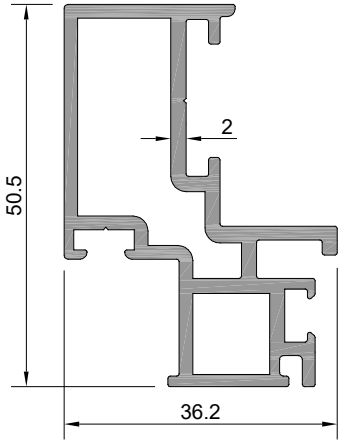

Profil No: SC0210
Ağırlık : 1001 gr/m



SC0308-a



SC0304-a



SC0307-a

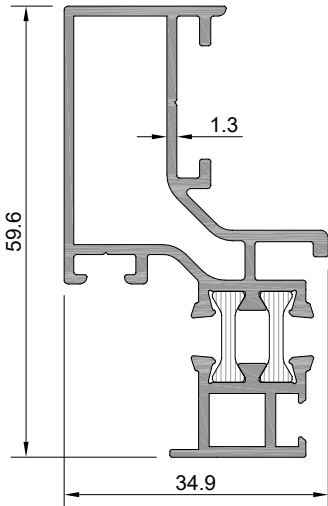

Profil No: SC0204

Ağırlık PVC : 970 gr/m

Ağırlık POLY : 963 gr/m



SC0308-b

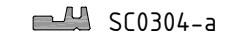

SC0304-a



SC0309-a

ÇT94
ÇELİK TAKVİYELİ CEPHE
STEEL REINFORCED FACADE

ÜRÜN TEKNİK ÖZELLİKLERİ
PRODUCT'S TECHNICAL FEATURES



SC0308-b

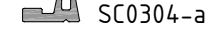

SC0304-a



SC0309-a



SC0308-b



SC0304-a



SC0309-a



SC0308-b

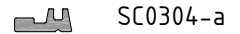

SC0304-a

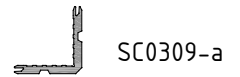

SC0309-a

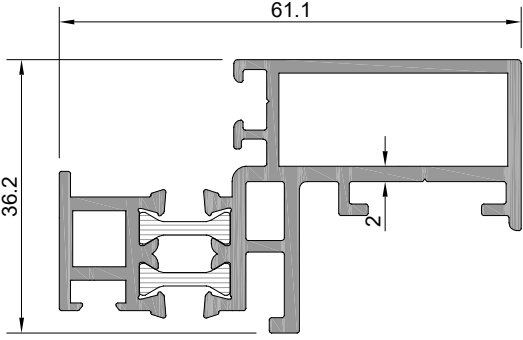

Profil No: SC0214

Ağırlık PVC : 1275 gr/m

Ağırlık POLY: 1268 gr/m

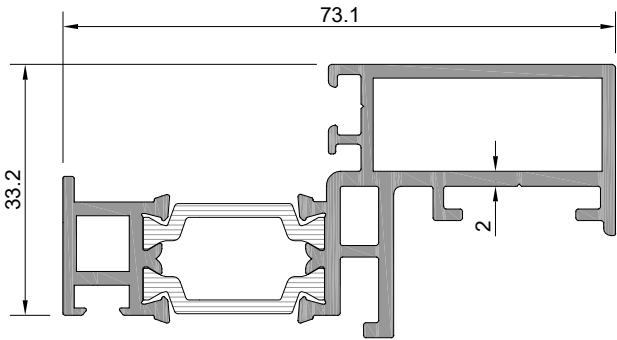

Profil No: SC0215

Ağırlık PVC : 1365 gr/m

Ağırlık POLY: 1350 gr/m

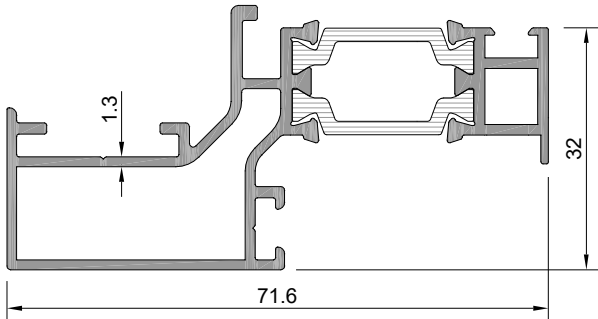

Profil No: SC0216

Ağırlık PVC : 1060 gr/m

Ağırlık POLY: 1045 gr/m

ÇT94
ÇELİK TAKVİYELİ CEPHE
STEEL REINFORCED FACADE

ÜRÜN TEKNİK ÖZELLİKLERİ
PRODUCT'S TECHNICAL FEATURES

Profil No : SC0218

Ağırlık : 1250 gr/m

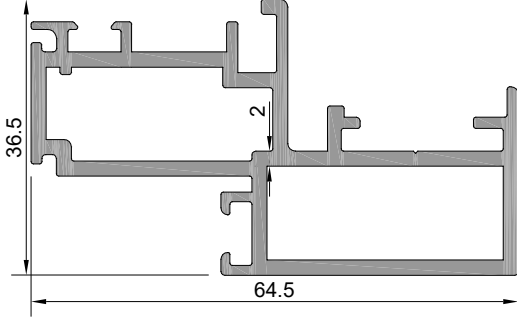

Profil No : SC0219

Ağırlık PVC : 1449 gr/m

Ağırlık POLY : 1442 gr/m

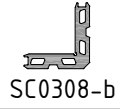
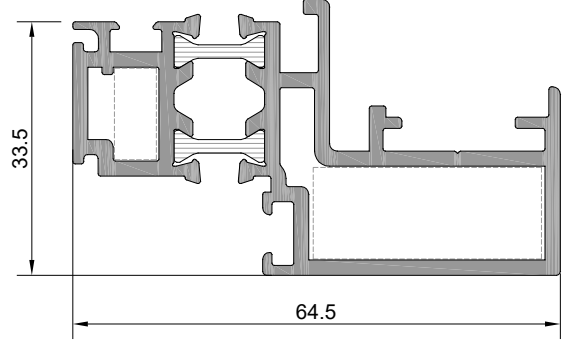

SC0308-b

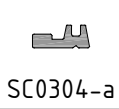

SC0304-a



SC0308-g

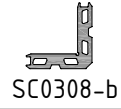

SC0308-b

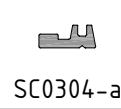

SC0304-a



SC0308-l

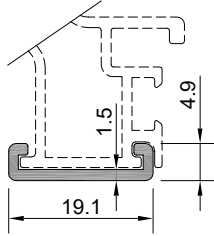

Profil No : SC0207

Ağırlık : 109 gr/m

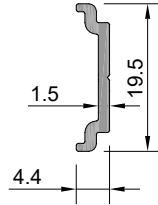

Profil No : SC0303

Ağırlık : 96 gr/m

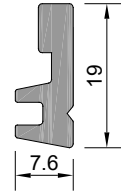

Profil No : SC0304

Ağırlık : 238 gr/m

SC0304-a 50 mm 100 adet/pcs

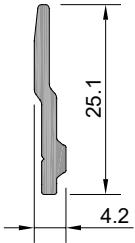

Profil No : SC0312

Ağırlık : 147 gr/m

SC0312-a 50 mm 100 adet/pcs

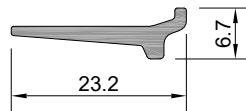

Profil No : SC0350

Ağırlık : 140 gr/m

SC0350-a 50 mm 100 adet/pcs

ÇT94
ÇELİK TAKVİYELİ CEPHE
STEEL REINFORCED FACADE

ÜRÜN TEKNİK ÖZELLİKLERİ
PRODUCT'S TECHNICAL FEATURES

SC0201

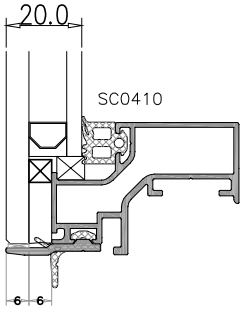

SC0210

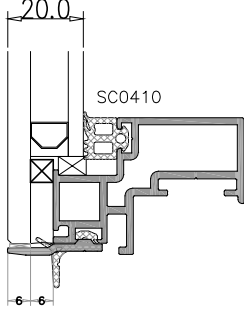

SC0204

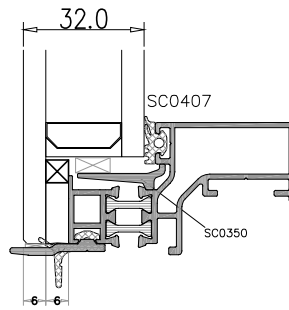

SC0214

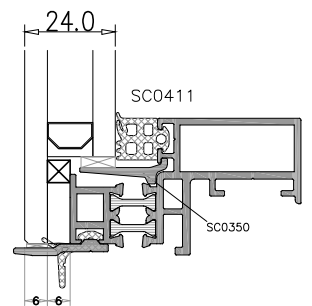
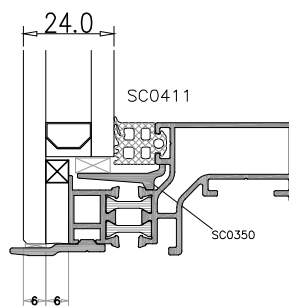
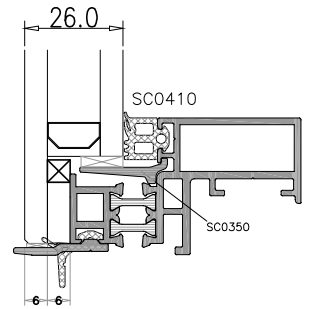
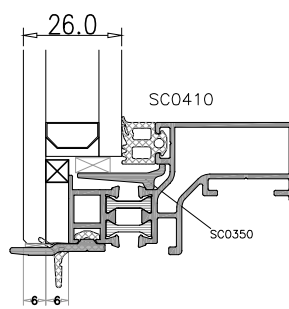
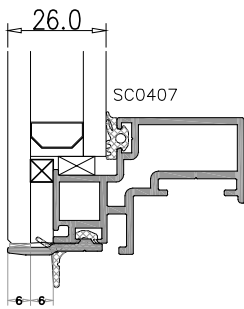
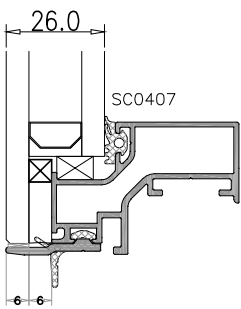
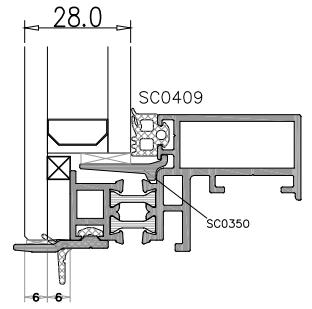
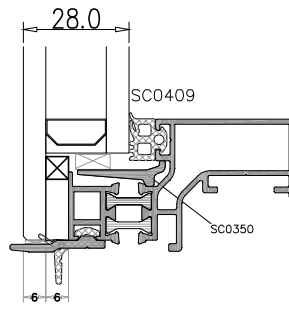
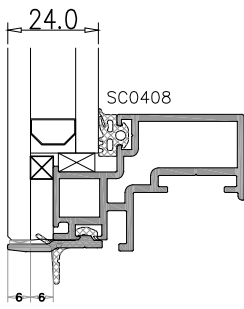
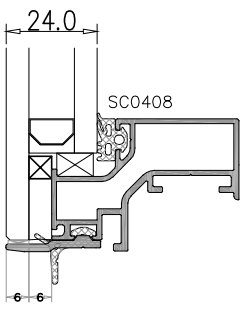
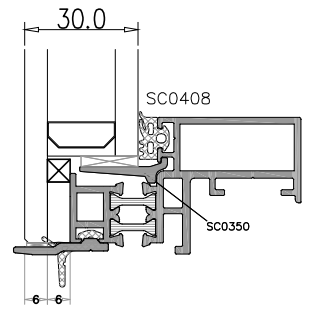
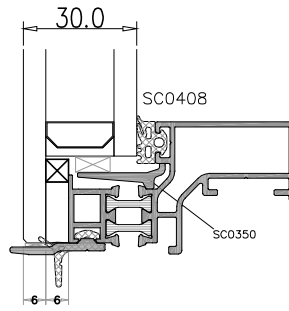
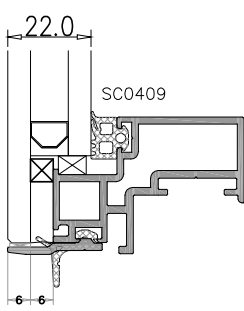
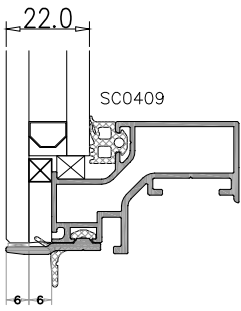
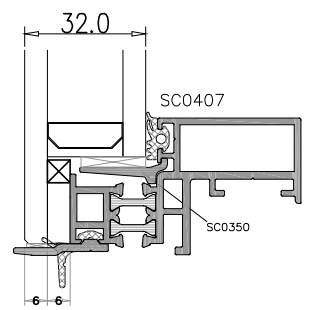

Profil değerleri teoriktir. Ağırlık olarak testimde yapılan tartım geçerlidir.
Profil imalatları TS EN 12020-2 ve TS EN 755-9 toleransı,
Moment değerleri EN 14024'e göre hesaplanmıştır.

Profile values are theoretical pre-shipment weight will be valid.
The tolerances of Profile manufacturing are calculated according to EN 12020-2
and TS EN 755-9; moment values are calculated according to EN 14024.

ÇT94
ÇELİK TAKVİYELİ CEPHE
STEEL REINFORCED FACADE

ÜRÜN TEKNİK ÖZELLİKLERİ
PRODUCT'S TECHNICAL FEATURES

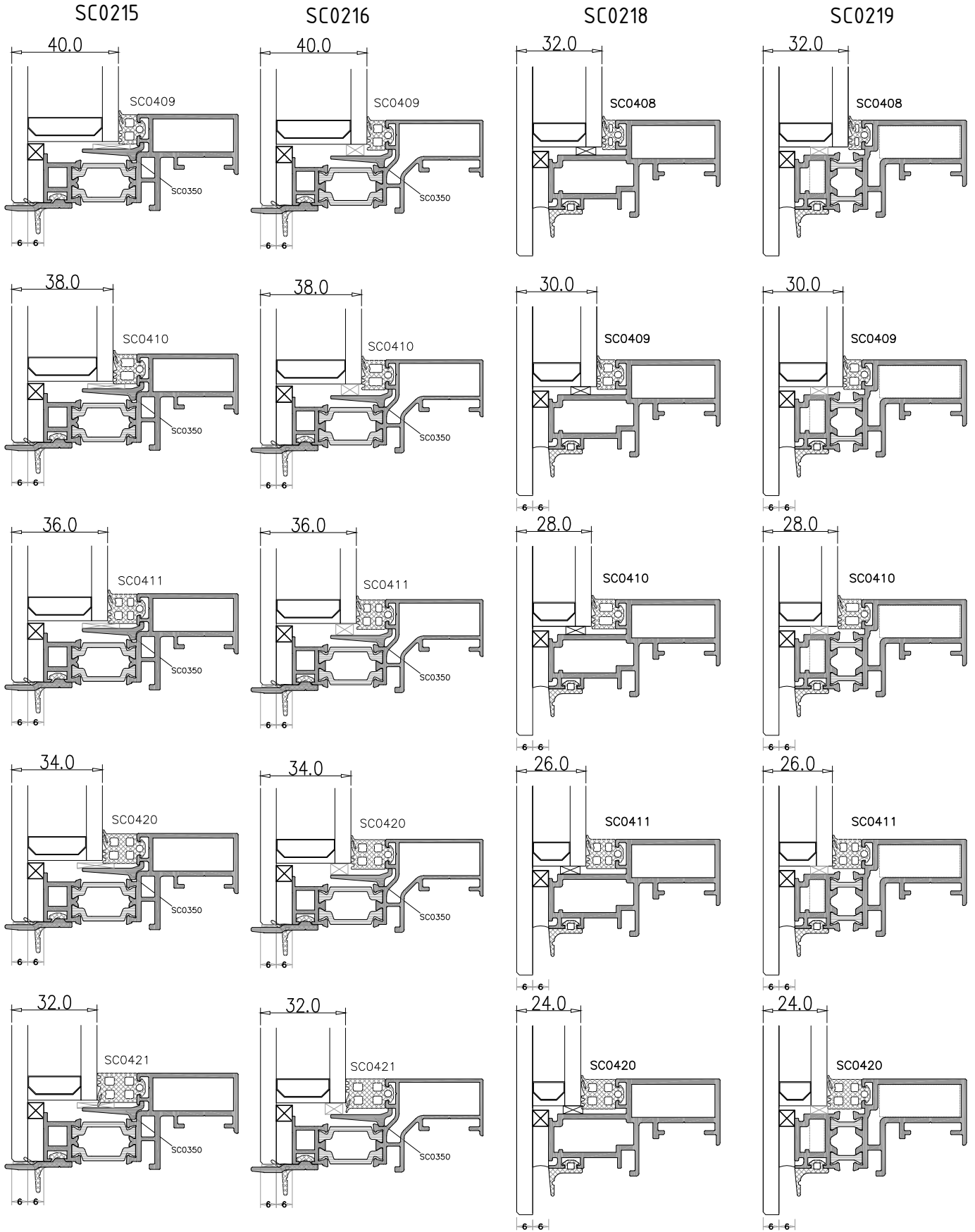

Profil değerleri teoriktir. Ağır olarak testimde yapılan tartım geçerlidir.
Profil imalatları TS EN 12020-2 ve TS EN 755-9 toleransı,
Moment değerleri EN 14024'e göre hesaplanmıştır.

Profile values are theoretical pre-shipment weight will be valid.
The tolerances of Profile manufacturing are calculated according to EN 12020-2
and TS EN 755-9; moment values are calculated according to EN 14024.

ÇT94
ÇELİK TAKVİYELİ CEPHE
STEEL REINFORCED FACADE

ÜRÜN TEKNİK ÖZELLİKLERİ
PRODUCT'S TECHNICAL FEATURES

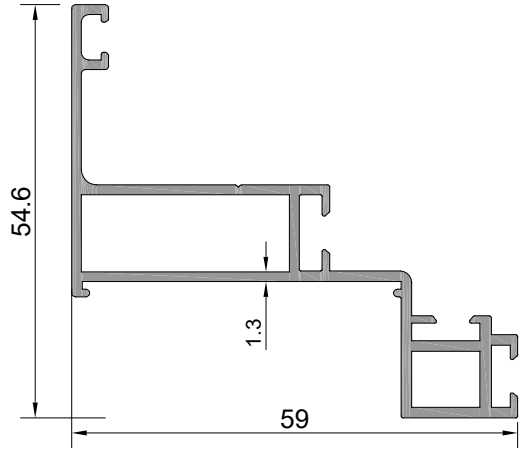

Profil No : KC0201
Ağırlık : 737 gr/m

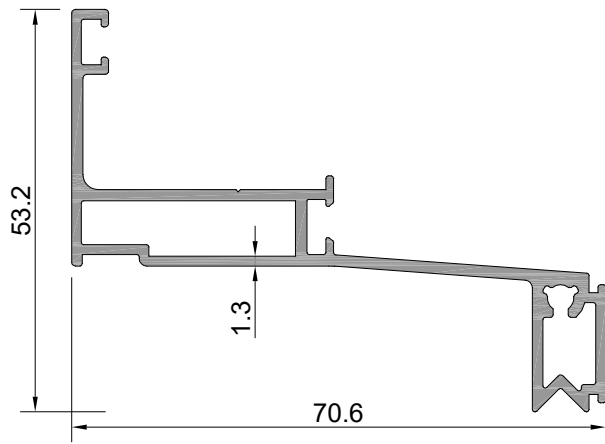

Profil No : KC0202
Ağırlık : 792 gr/m

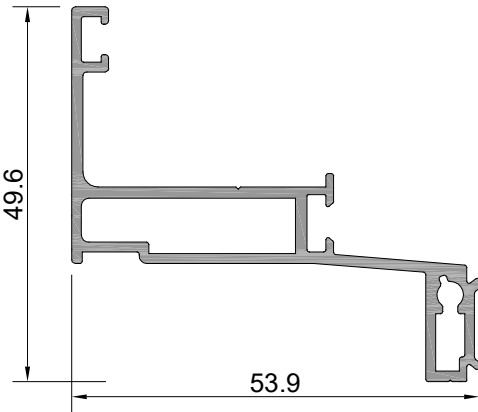

Profil No : KC0203
Ağırlık : 662 gr/m

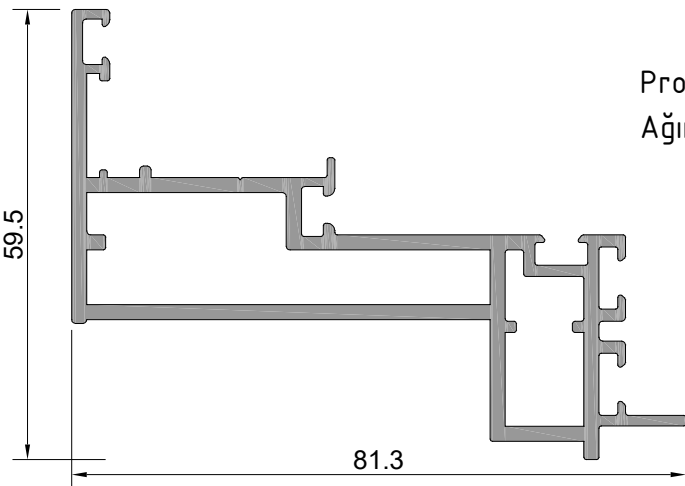

Profil No : KC0204
Ağırlık : 1463 gr/m



ÇT94
ÇELİK TAKVİYELİ CEPHE
STEEL REINFORCED FACADE

ÜRÜN TEKNİK ÖZELLİKLERİ
PRODUCT'S TECHNICAL FEATURES

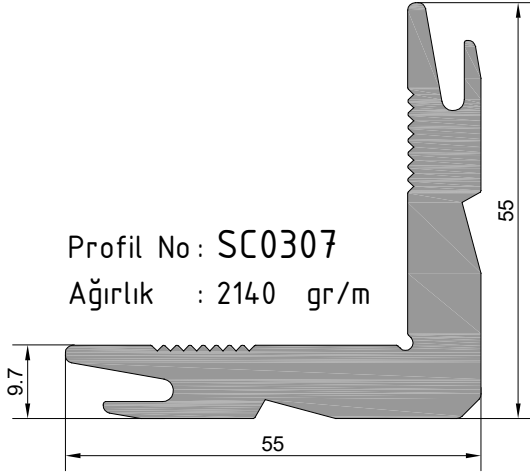

SC0307-a	10.25mm	100 adet/pcs
SC0307-b	27mm	100 adet/pcs
SC0307-c	8.5mm	100 adet/pcs
SC0307-d	23.9mm	100 adet/pcs
SC0307-e	6.3mm	100 adet/pcs

SC0307-f	25.6mm	100 adet/pcs
SC0307-g	6mm	100 adet/pcs
SC0307-h	4.7mm	100 adet/pcs
SC0307-ı	26.28mm	100 adet/pcs
SC0307-j	29.5mm	100 adet/pcs

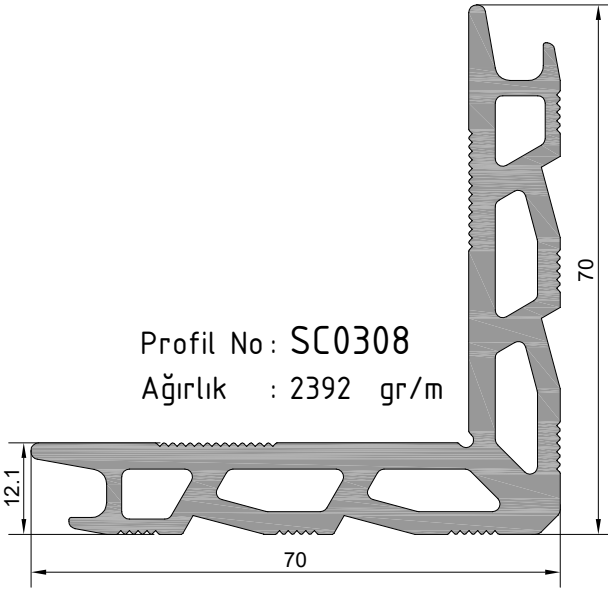

SC0308-a	25.68mm	100 adet/pcs
SC0308-b	29.74mm	100 adet/pcs
SC0308-c	24.36mm	100 adet/pcs
SC0308-d	10.30mm	100 adet/pcs
SC0308-e	6.70mm	100 adet/pcs
SC0308-f	23mm	100 adet/pcs
SC0308-g	19.50mm	100 adet/pcs

SC0308-h	9.9mm	100 adet/pcs
SC0308-j	9.2mm	100 adet/pcs
SC0308-k	39mm	100 adet/pcs
SC0308-l	5.6mm	100 adet/pcs

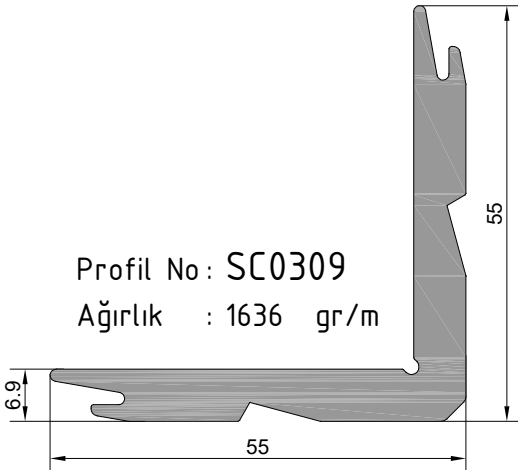

SC0309-a	6.5mm	100 adet/pcs
SC0309-b	8.5mm	100 adet/pcs
SC0309-c	18.9mm	100 adet/pcs
SC0309-d	20mm	100 adet/pcs
SC0309-e	25.3mm	100 adet/pcs

SC0309-f	4.7mm	100 adet/pcs
SC0309-g	54.2mm	100 adet/pcs
SC0309-h	23.8mm	100 adet/pcs
SC0309-ı	48.2mm	100 adet/pcs
SC0309-j	52.8mm	100 adet/pcs

ÇT94
ÇELİK TAKVİYELİ CEPHE
STEEL REINFORCED FAÇADE

ÜRÜN TEKNİK ÖZELLİKLERİ
PRODUCT'S TECHNICAL FEATURES

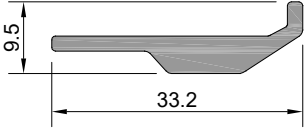

Profil No : KC0336
Ağırlık : 305 gr/m

KC0336-a	50 mm	100 adet/pcs
----------	-------	--------------

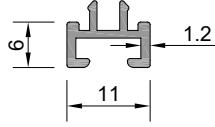

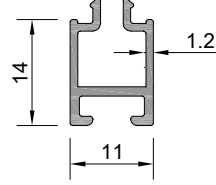

Profil No : KC0350
Ağırlık : 96 gr/m

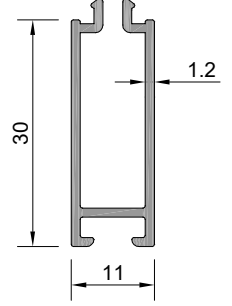

Profil No : KC0351
Ağırlık : 154 gr/m



Profil No : KC0352 
Ağırlık : 274 gr/m
 İşaretili profil için satış ekibinden bilgi alınır.

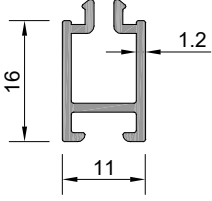

Profil No : KC0333
Ağırlık : 183 gr/m

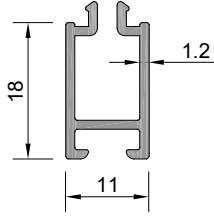

Profil No : KC0334
Ağırlık : 196 gr/m

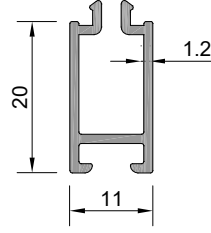

Profil No : KC0331
Ağırlık : 209 gr/m

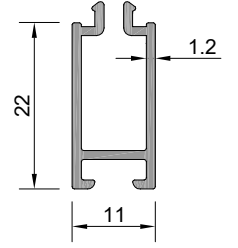

Profil No : KC0332
Ağırlık : 222 gr/m

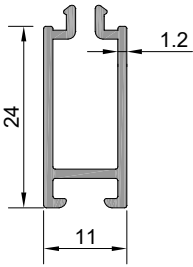

Profil No : KC0347
Ağırlık : 235 gr/m

ÇT94
ÇELİK TAKVİYELİ CEPHE
STEEL REINFORCED FACADE

SABİT - SABİT
FIXED-FIXED

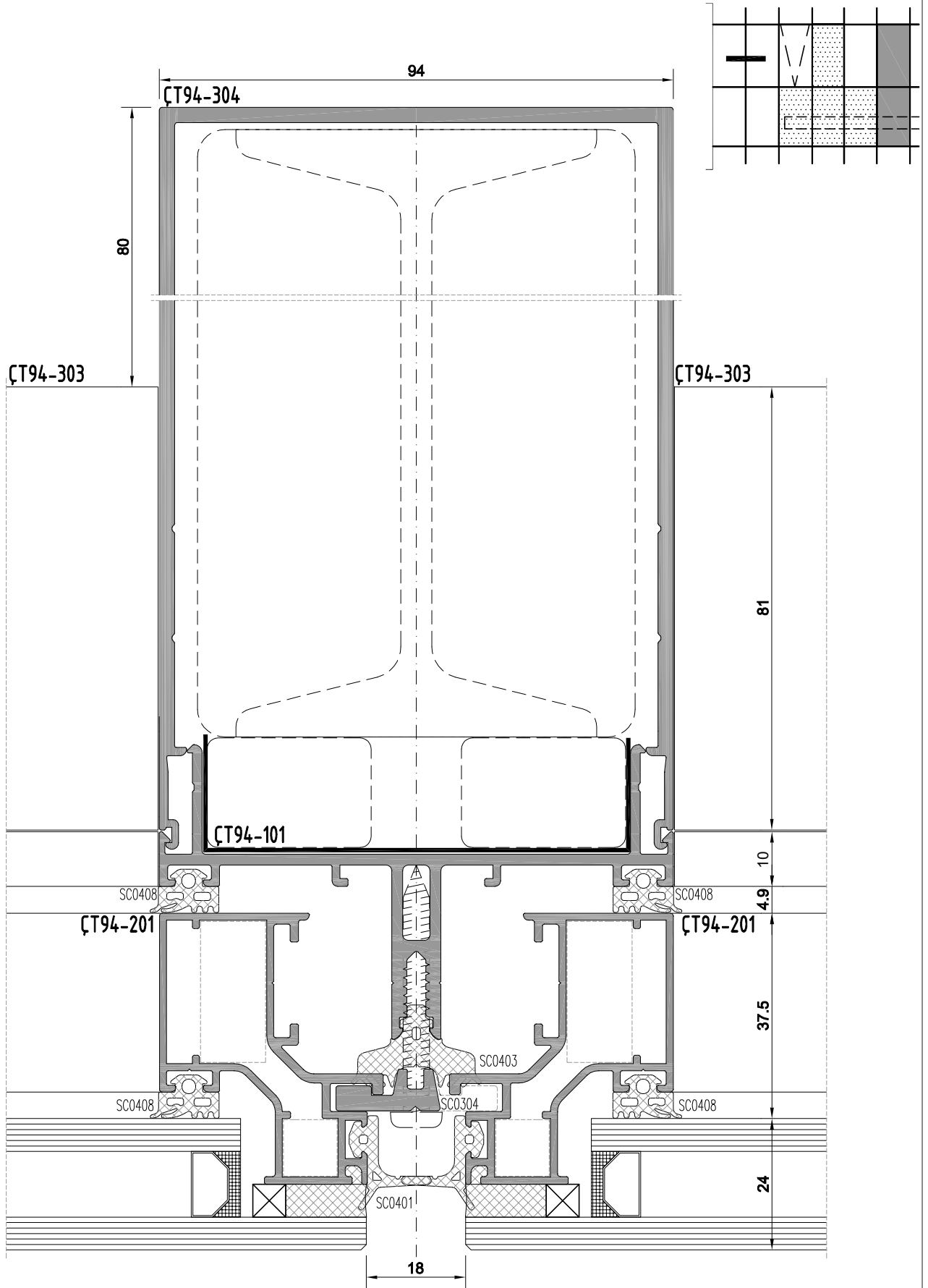

ÇT94
ÇELİK TAKVİYELİ CEPHE
STEEL REINFORCED FACADE

SABİT - KANAT
FIXED-SASH

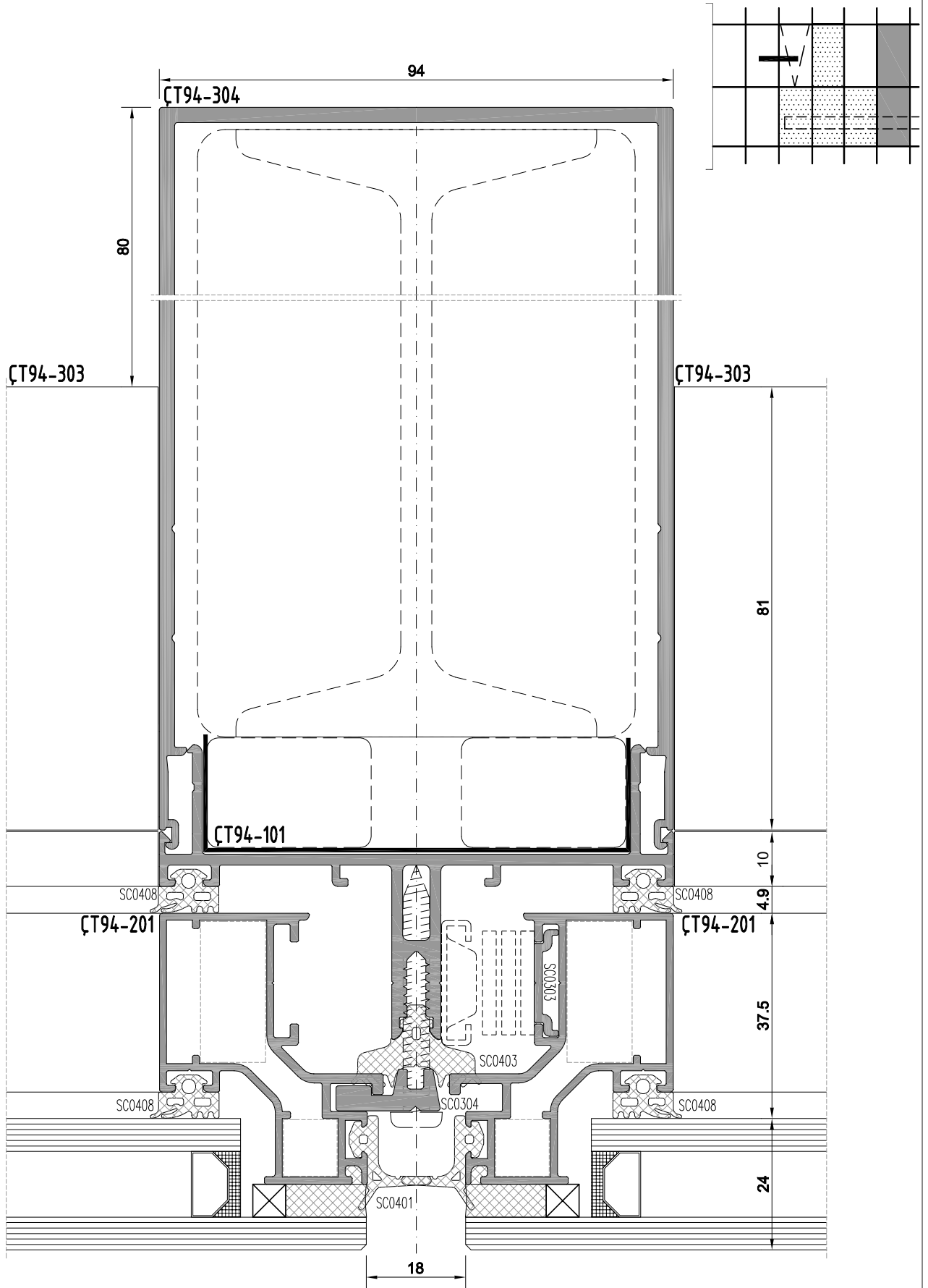

ÇT94
ÇELİK TAKVİYELİ CEPHE
STEEL REINFORCED FAÇADE

SABİT - SABİT
FIXED-FIXED

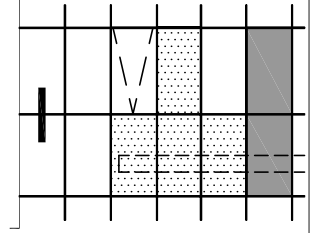

ÇT94-304

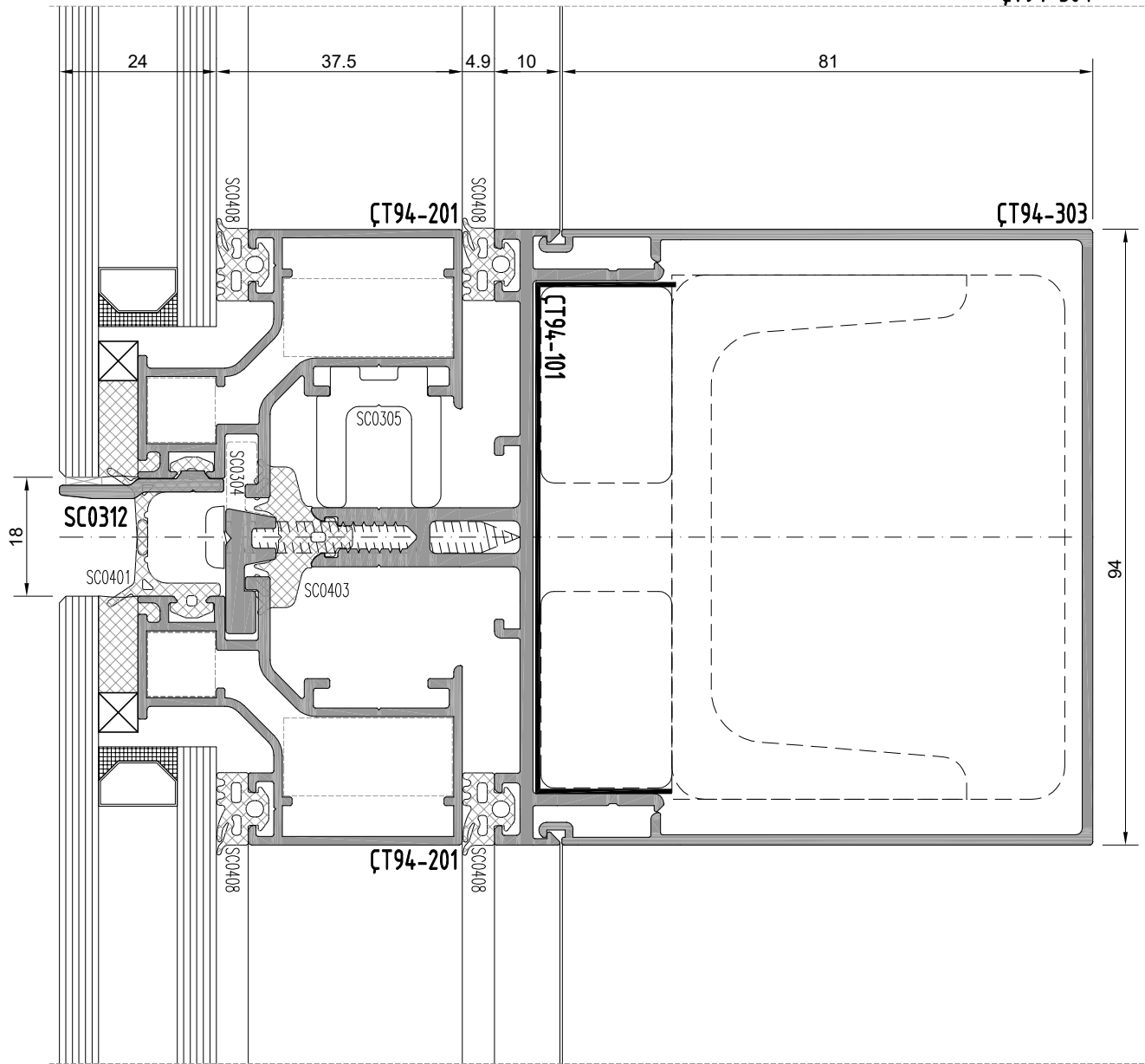

ÇT94
ÇELİK TAKVİYELİ CEPHE
STEEL REINFORCED FAÇADE

KANAT - SPANDREL
SASH-SPANDREL

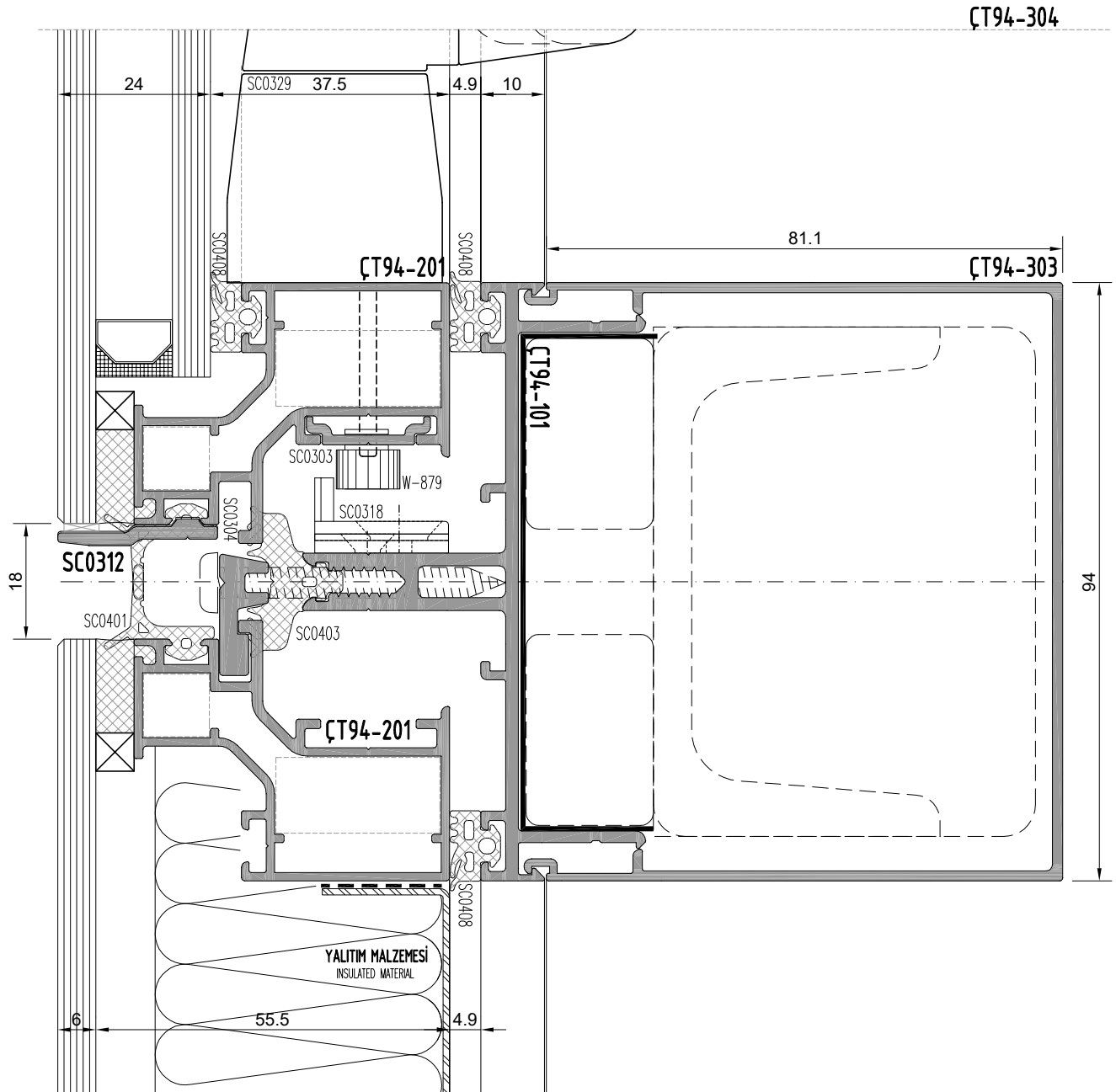
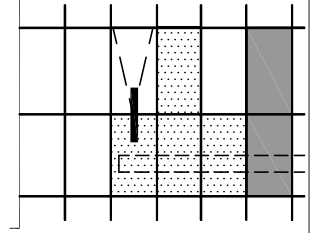

ÇT94
ÇELİK TAKVİYELİ CEPHE
STEEL REINFORCED FAÇADE

SABİT - SABİT
FIXED-FIXED

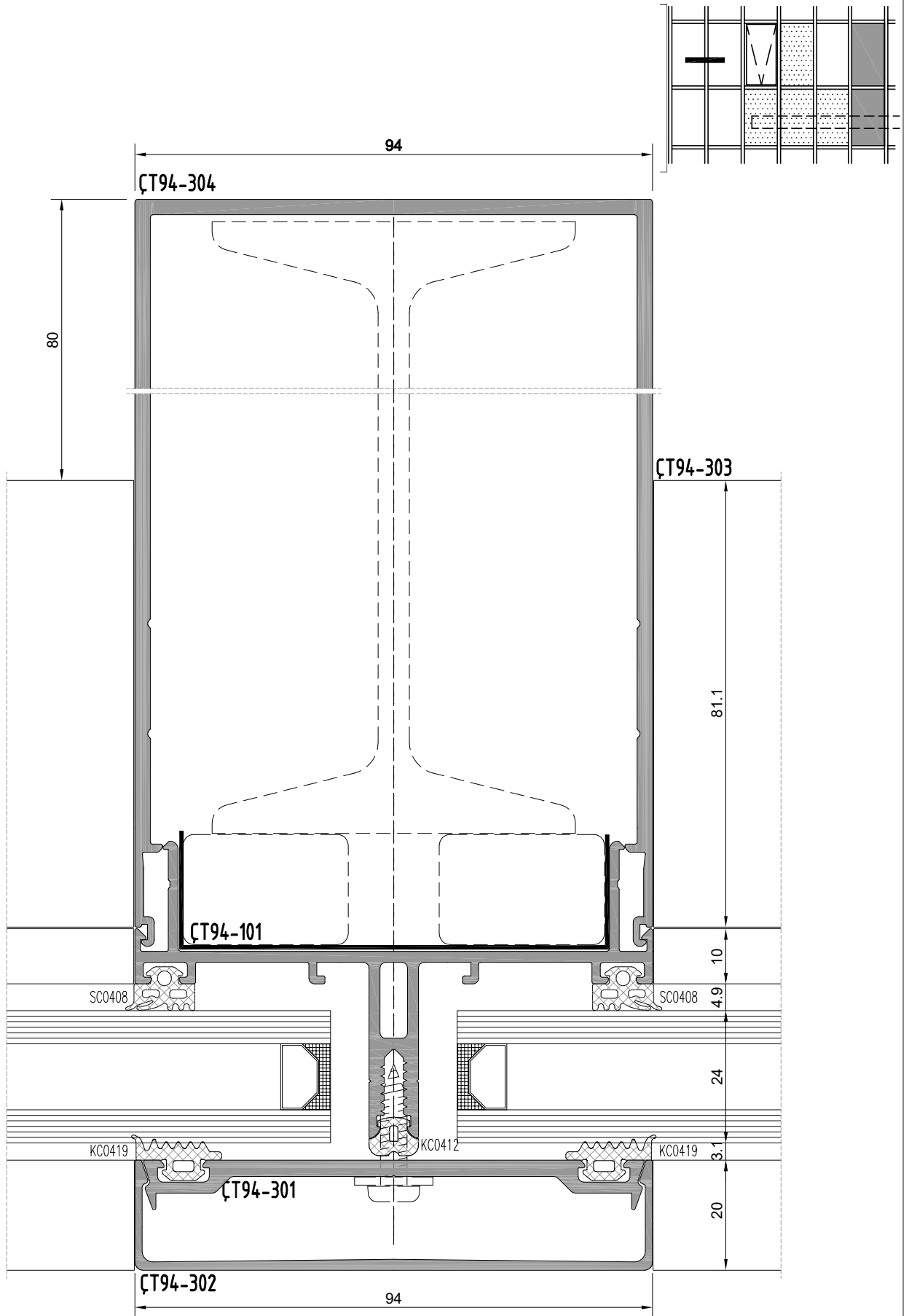

ÇT94
ÇELİK TAKVİYELİ CEPHE
STEEL REINFORCED FAÇADE

SABİT - KANAT
FIXED-SASH

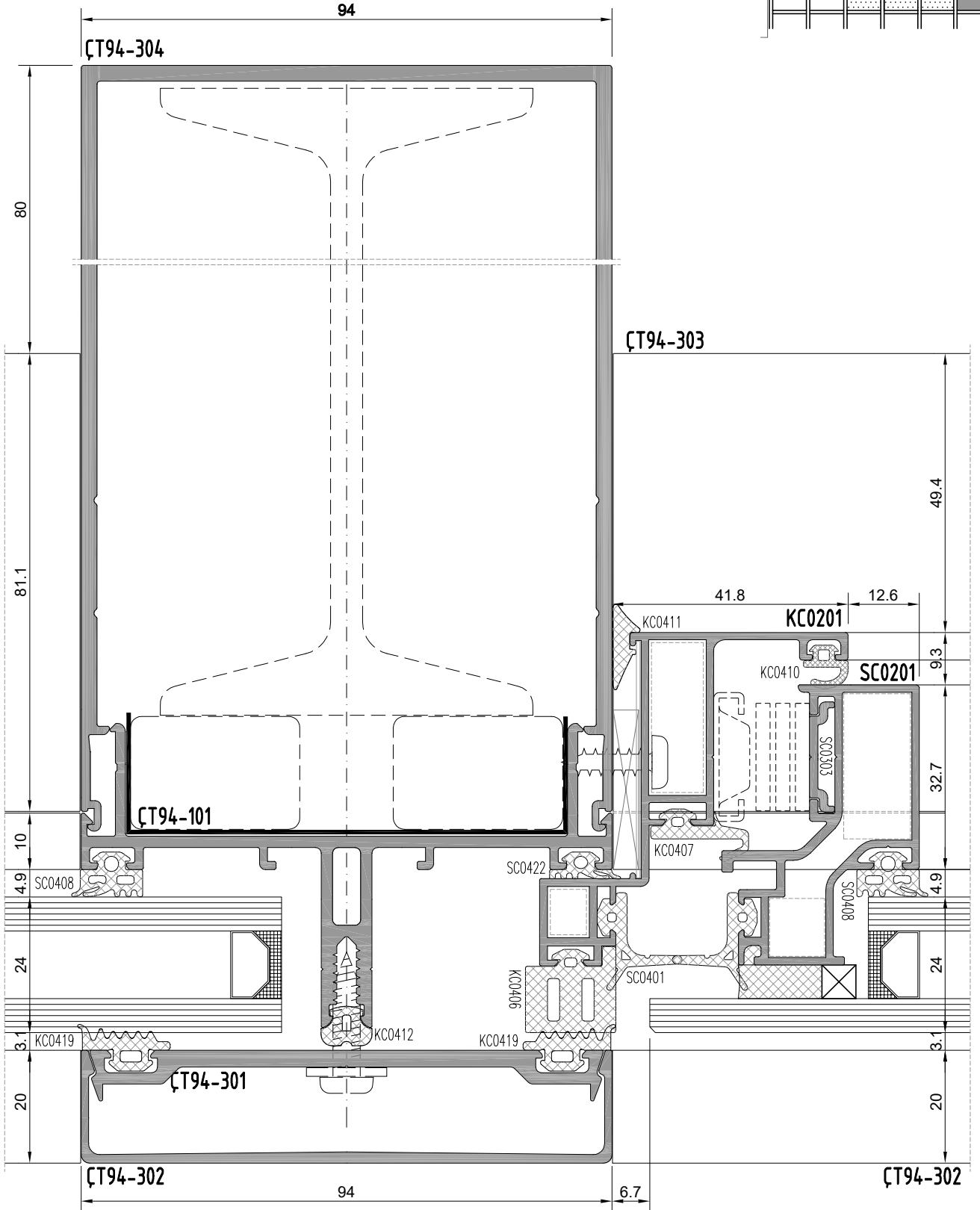
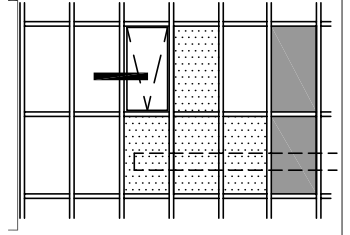

ÇT94
ÇELİK TAKVİYELİ CEPHE
STEEL REINFORCED FAÇADE

SABIT - KANAT
FIXED-SASH

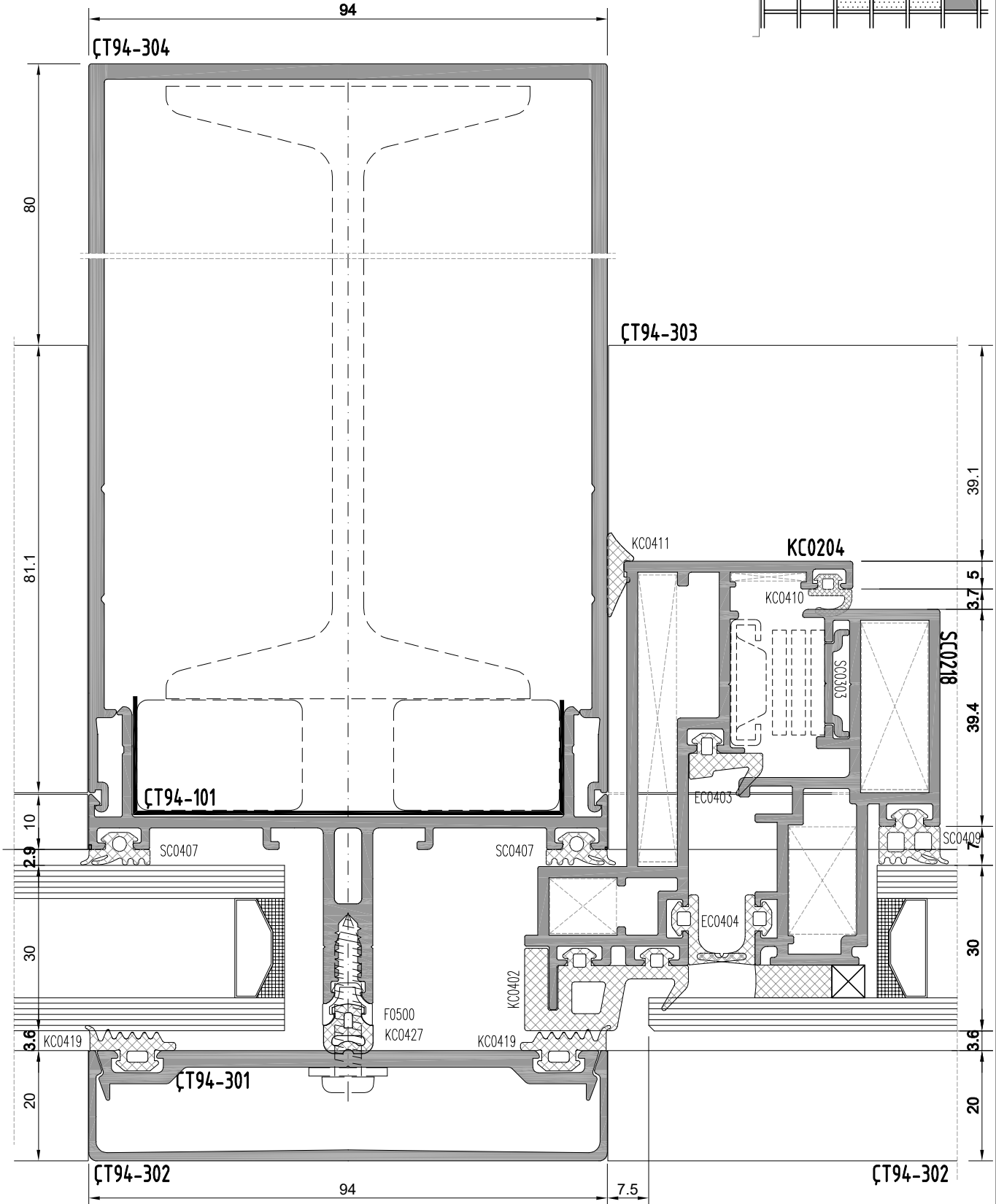
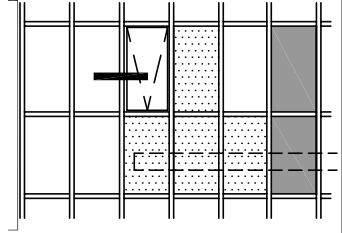

ÇT94
ÇELİK TAKVİYELİ CEPHE
STEEL REINFORCED FACADE

SABIT - KANAT
FIXED-SASH

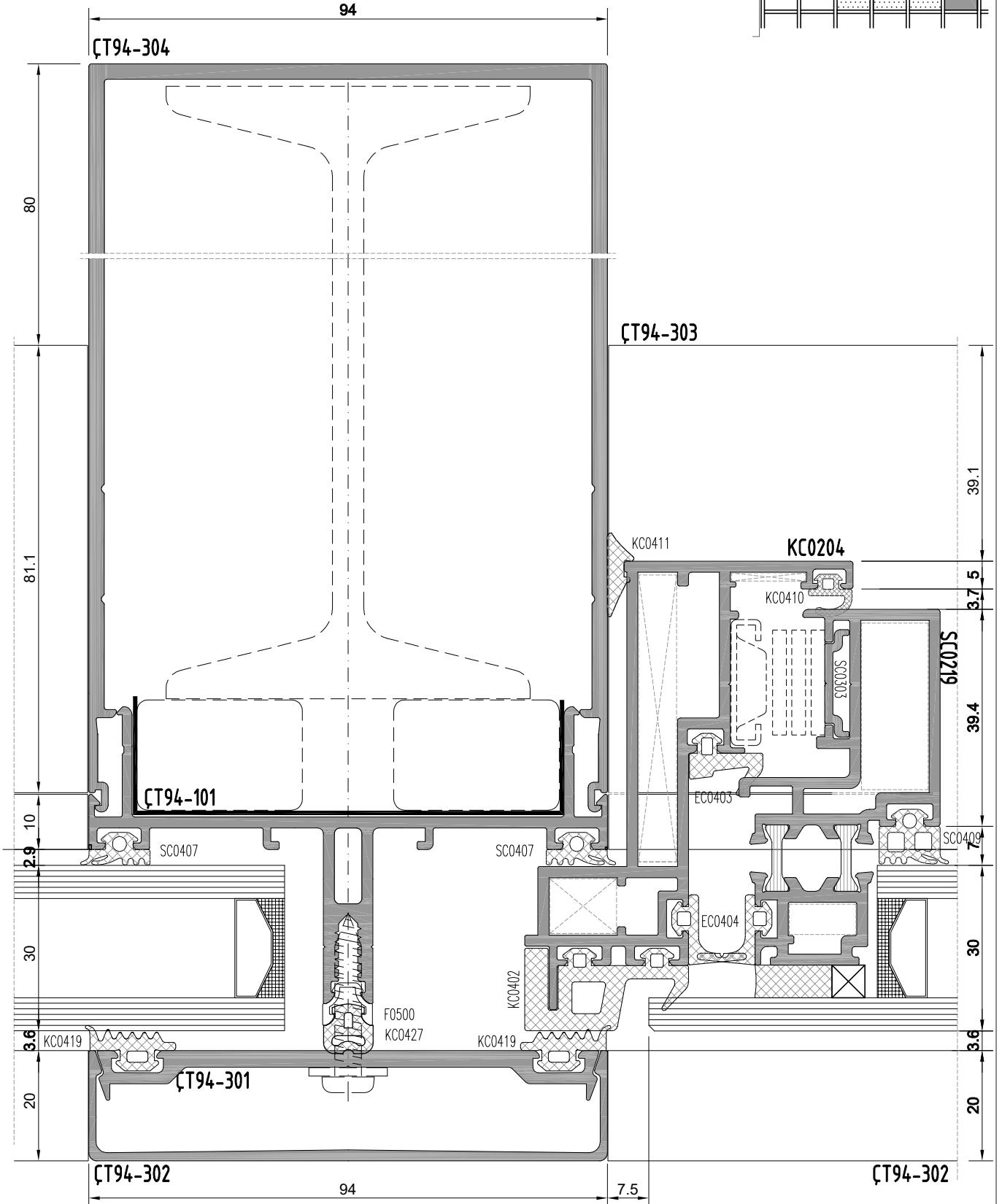
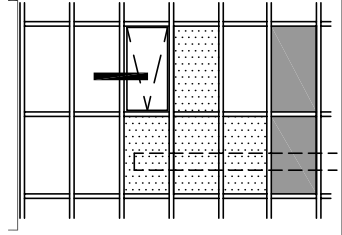

ÇT94
ÇELİK TAKVİYELİ CEPHE
STEEL REINFORCED FAÇADE

KANAT - SABİT
SASH-FIXED

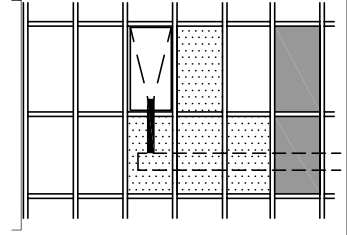

ÇT94-304

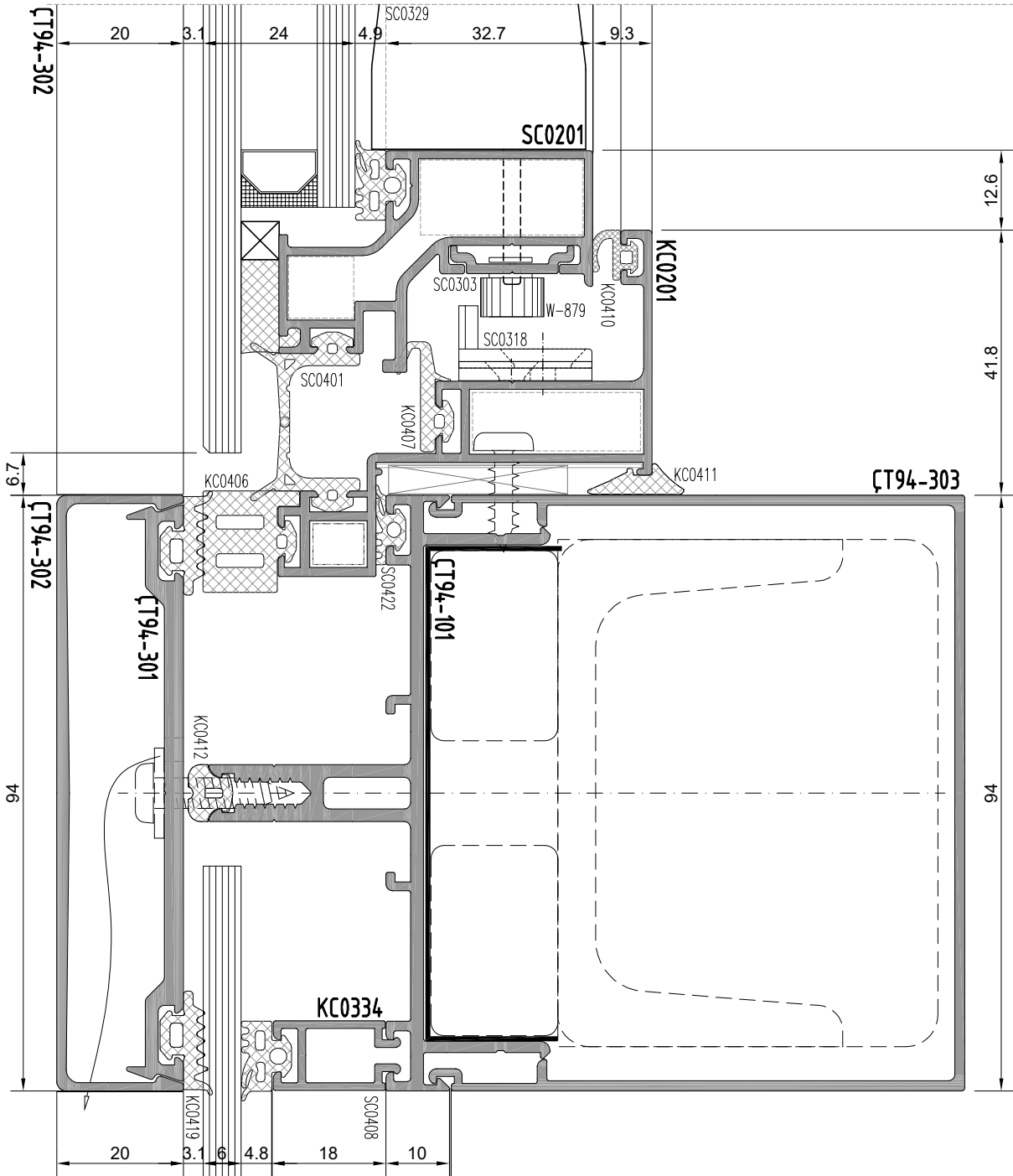

ÇT94
ÇELİK TAKVİYELİ CEPHE
STEEL REINFORCED FAÇADE

SABİT - SABİT
FIXED-FIXED

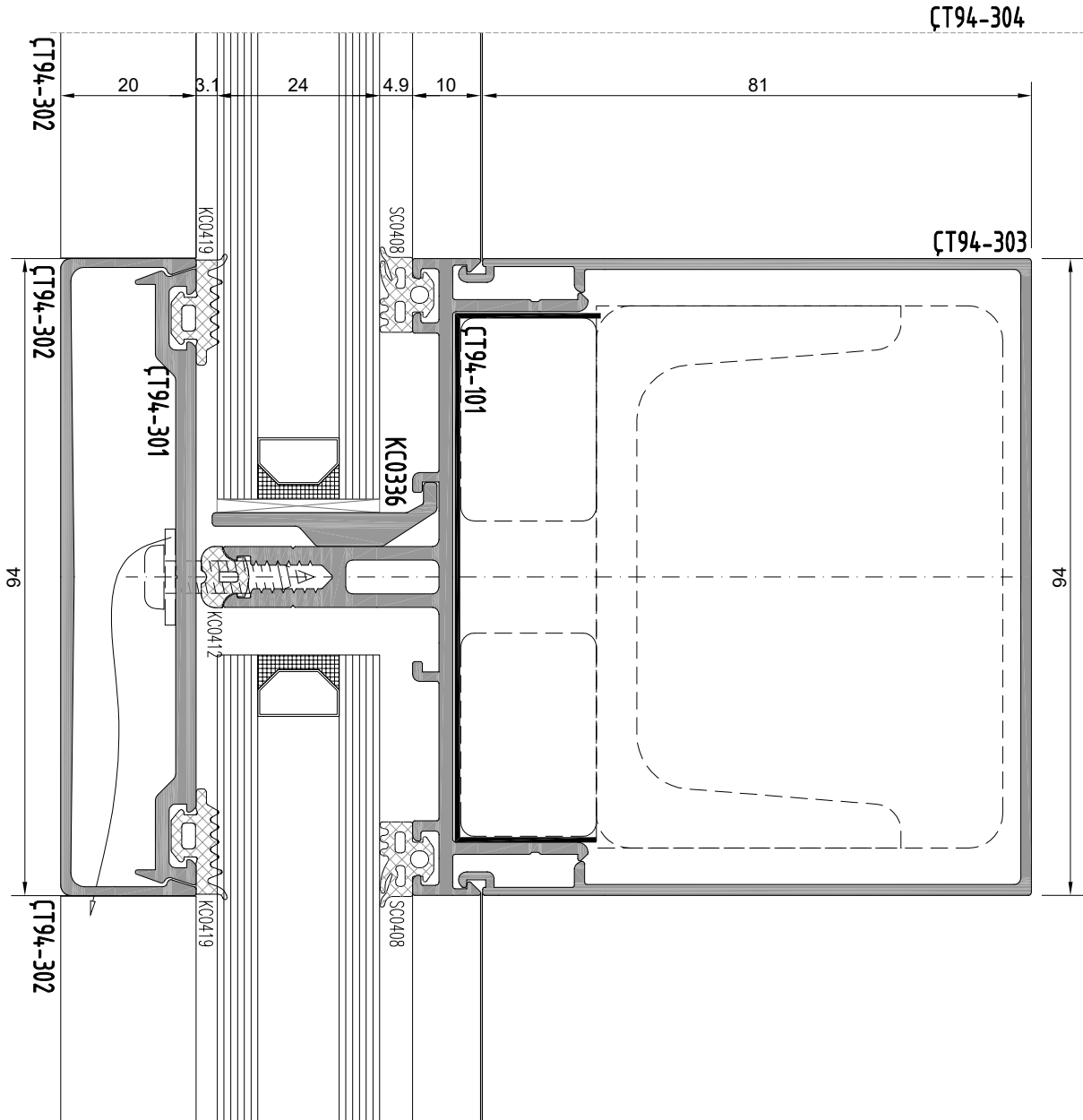
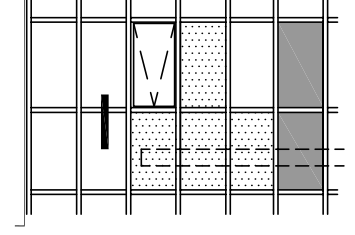

ÇT94
ÇELİK TAKVİYELİ CEPHE
STEEL REINFORCED FAÇADE

KANAT - SABİT
SASH-FIXED

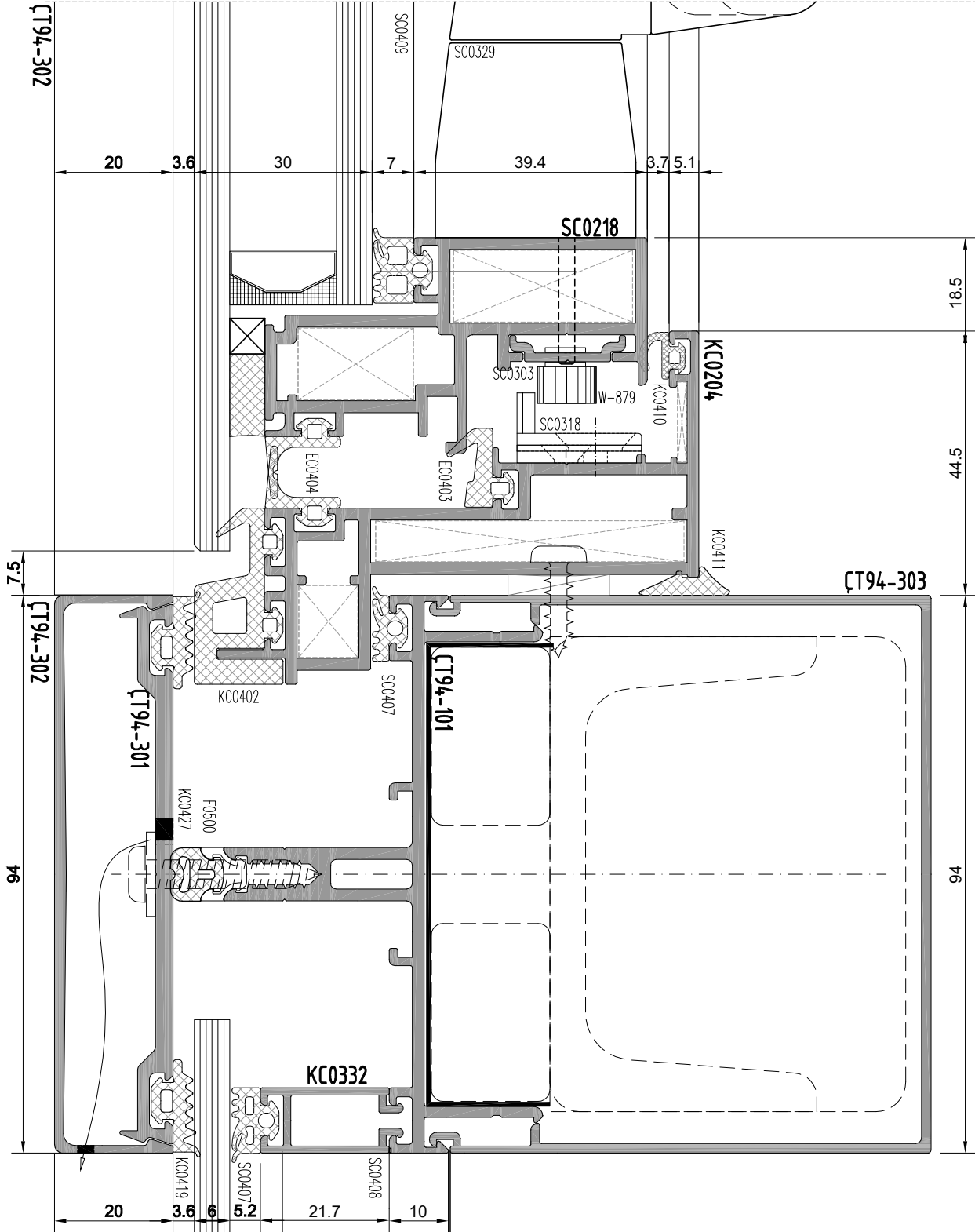
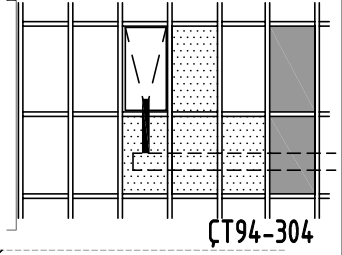

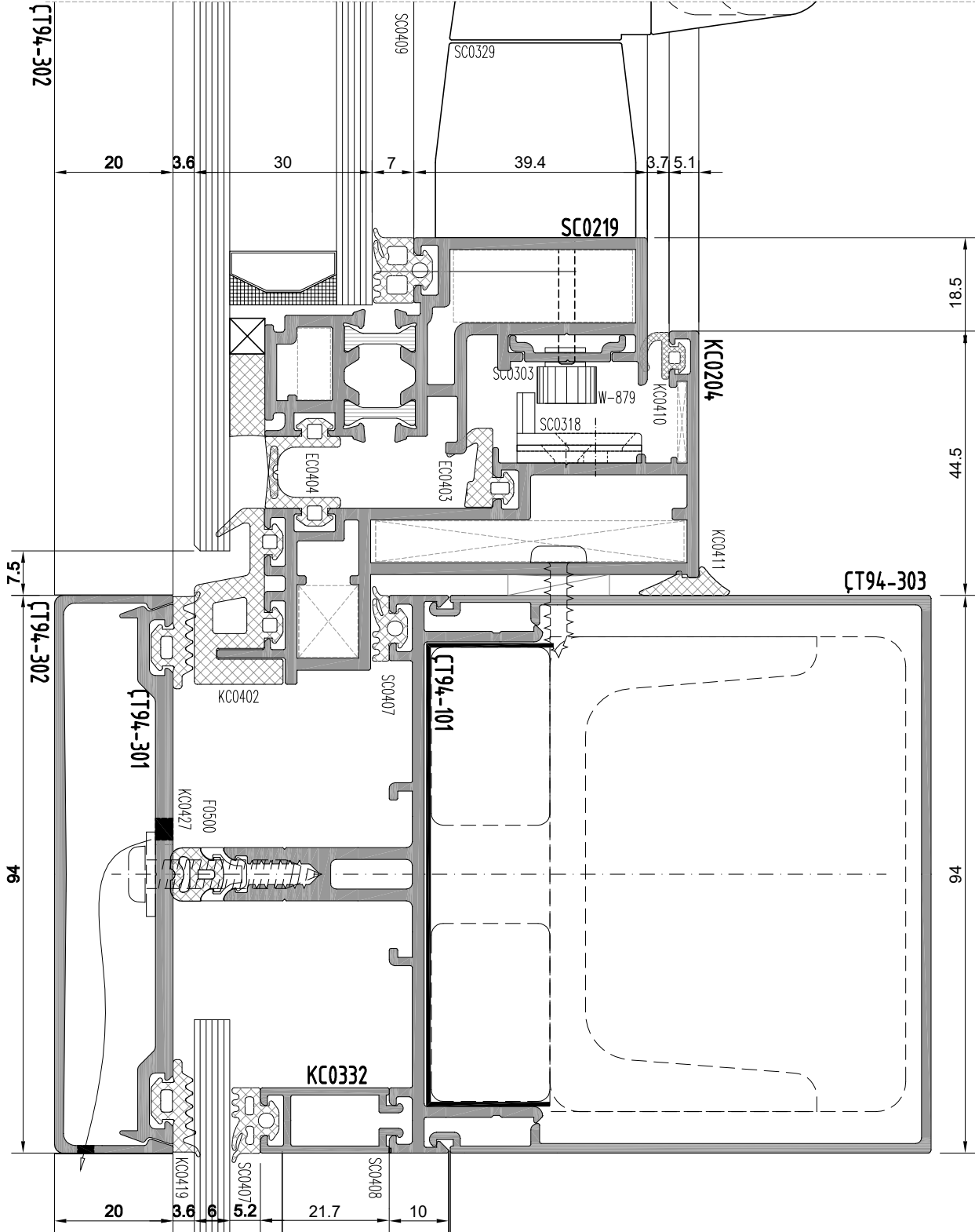
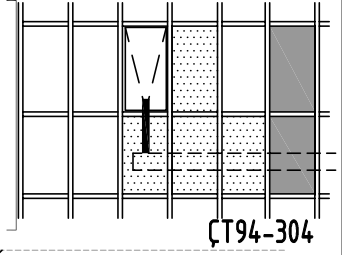

ÇT94
ÇELİK TAKVİYELİ CEPHE
STEEL REINFORCED FAÇADE

KANAT - SABİT
SASH-FIXED

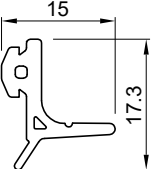
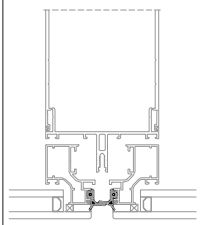
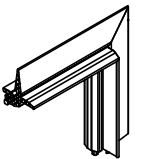
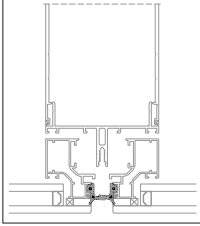
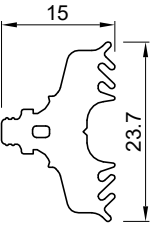
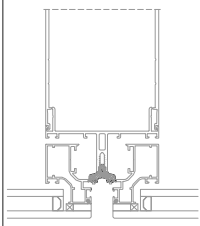

ÇT94
ÇELİK TAKVİYELİ CEPHE
STEEL REINFORCED FACADE

Fitil listesi
Gasket list

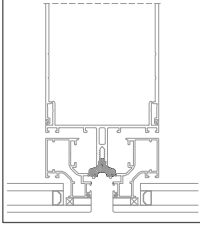
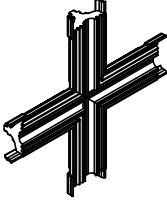
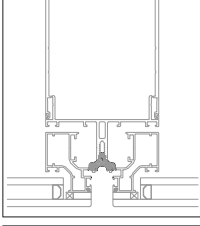
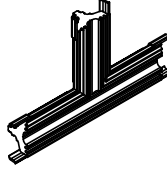
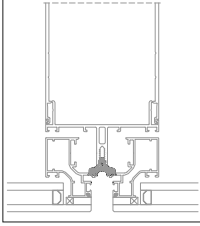
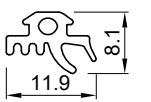
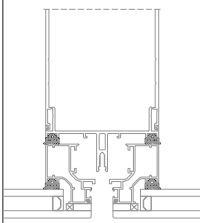
kod code	şekil drawing	tanım description	teorik ağırlık theoretical weight gr / m	paket ağırlığı package weight kg / package	paket metrajı in one package metre / package	kullanım yeri aplication
SC0401		Panel dış fitili Frame gasket	74 gr/m	15 kg	202 m	
SC0402		Panel dış fitili (köşe) Frame gasket (corner)	89 gr\m	-	50 ad-pcs	
SC0403		Taşıyıcı ön fitili Mullion or transom front gasket	173 gr/m	15 kg	76 m	
SC0404		Taşıyıcı ön fitili (L merkez) Mullion or transom front gasket (L center)	17,6 gr\ad	-	50 ad-pcs	
SC0405		Taşıyıcı ön fitili (T merkez) Mullion or transom front gasket (T center)	31,6 gr\ad	-	50 ad-pcs	
SC0406		Taşıyıcı ön fitili (+ merkez) Mullion or transom front gasket (+ center)	24,6 gr\ad	-	50 ad-pcs	
SC0422		Taşıyıcı ve Panel iç fitili Mullion-transom or Panel gasket inside	46 gr/m	15 kg	326 m	

ÇT94
ÇELİK TAKVİYELİ CEPHE
STEEL REINFORCED FACADE

Fitil listesi
Gasket list

kod code	şekil drawing	tanım description	teorik ağırlık theoretical weight gr / m	paket ağırlığı package weight kg / package	paket metrajı in one package metre / package	kullanım yeri aplication
SC0407		Taşıyıcı ve Panel iç fitili Mullion-transom or Panel gasket inside	73 gr/m	15 kg	205 m	
SC0408		Taşıyıcı ve Panel iç fitili Mullion-transom or Panel gasket inside	88 gr/m	15 kg	170 m	
SC0409		Taşıyıcı ve Panel iç fitili Mullion-transom or Panel gasket inside	101 gr/m	15 kg	148 m	
SC0410		Taşıyıcı ve Panel iç fitili Mullion-transom or Panel gasket inside	113 gr/m	15 kg	133 m	
SC0411		Taşıyıcı ve Panel iç fitili Mullion-transom or Panel gasket inside	144 gr/m	15 kg	104 m	
SC0420		Taşıyıcı ve Panel iç fitili Mullion-transom or Panel gasket inside	167 gr/m	15 kg	90 m	
SC0421		Taşıyıcı ve Panel iç fitili Mullion-transom or Panel gasket inside	189 gr/m	15 kg	79 m	

ÇT94
ÇELİK TAKVİYELİ CEPHE
STEEL REINFORCED FACADE

Fitil listesi
Gasket list

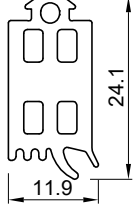
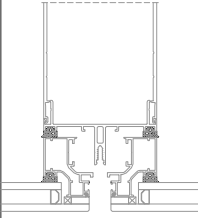
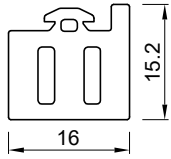
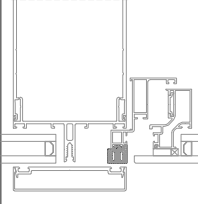
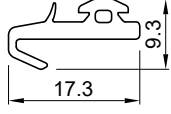
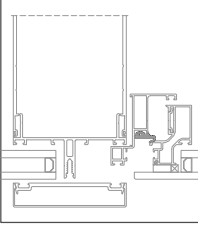
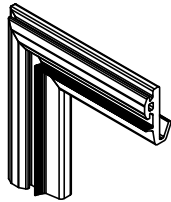
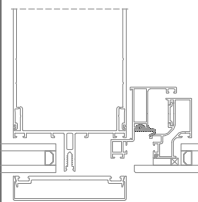
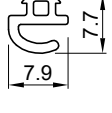
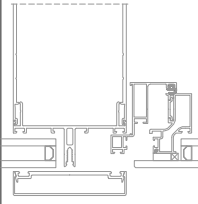
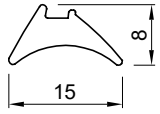
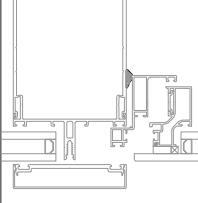
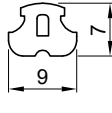
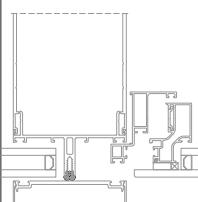
kod code	şekil drawing	tanım description	teorik ağırlık theoretical weight gr / m	paket ağırlığı package weight kg / package	paket metrajı in one package metre / package	kullanım yeri aplication
SC0425		Taşıyıcı ve Panel iç fitili Mullion-transom or Panel gasket inside	217,6 gr/m	15 kg	69 m	
KC0406		Kasa dış fitili Frame gasket	256 gr/m	15 kg	58,5 m	
KC0407		Kasa bini fitili Frame gasket	72,5 gr/m	15 kg	207 m	
KC0408		Kasa bini köşe fitili Frame gasket (corner)	-	-	50 ad-pcs	
KC0410		Kasa çarpma fitili Frame gasket	34 gr/m	15 kg	441 m	
KC0411		Kasa çarpma fitili Frame gasket	64 gr/m	15 kg	234 m	
KC0412		Taşıyıcı ön fitili Mullion-transom gasket front	24,6 gr/m	15 kg	275 m	

ÇT94
ÇELİK TAKVİYELİ CEPHE
STEEL REINFORCED FACADE

Fitil listesi
Gasket list

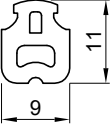
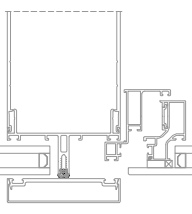
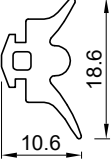
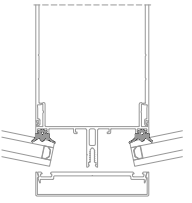
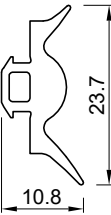
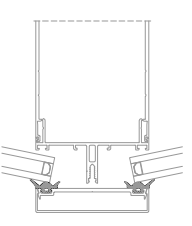
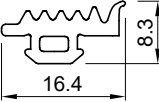
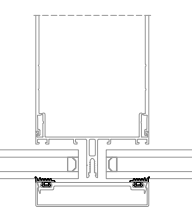
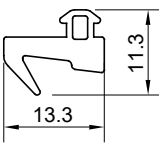
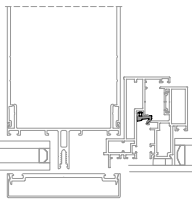
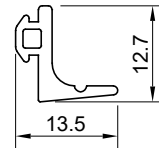
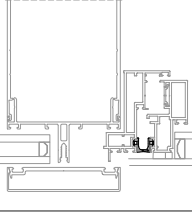
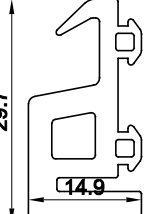
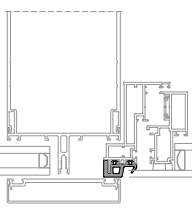
kod code	şekil drawing	tanım description	teorik ağırlık theoretical weight gr / m	paket ağırlığı package weight kg / package	paket metrajı in one package metre / package	kullanım yeri aplication
KC0413		Taşıyıcı ön fitili Mullion-transom gasket front	80 gr/m	15 kg	187,5 m	
KC0415		Açılı köşe fitili Mullion-transom gasket inside	80 gr/m	15 kg	187.5 m	
KC0417		Açılı köşe fitili Mullion-transom gasket inside	96 gr/m	15 kg	156 m	
KC0419		Baskı profil fitili Glazing gasket	73 gr/m	15 kg	205 m	
EC0403		Kasa bini fitili Frame gasket	80 gr/m	15 kg	187.5 m	
EC0404		Panel dış fitili Frame gasket	59 gr/m	15 kg	254 m	
KC0402		Kasa dış fitili Frame gasket	302.5 gr/m	15 kg	50 m	

Profil değerleri teoriktir. Ağırlık olarak testimde yapılan tartım geçerlidir.
Profil imalatları TS EN 12020-2 ve TS EN 755-9 toleransı,
Moment değerleri EN 14024'e göre hesaplanmıştır.

Profile values are theoretical pre-shipment weight will be valid.
The tolerances of Profile manufacturing are calculated according to EN 12020-2
and TS EN 755-9; moment values are calculated according to EN 14024.

ÇT94
ÇELİK TAKVİYELİ CEPHE
STEEL REINFORCED FACADE

Pvc ızalasyon listesi
Pvc ızalator list

kod code	şekil drawing	tanım description	metraji metre / package	kullanım yeri aplication
F0500		Taşıyıcı ön ızalasyon (pvc) Mullion or transom front ızalator (pvc)	31 m	
F0501		Taşıyıcı ön ızalasyon (pvc) Mullion or transom front ızalator (pvc)	71 m	
F0502		Taşıyıcı ön ızalasyon (pvc) Mullion or transom front ızalator (pvc)	87,5 m	
F0503		Taşıyıcı ön ızalasyon (pvc) Mullion or transom front ızalator (pvc)	95,6 m	
F0504		Taşıyıcı ön ızalasyon (pvc) Mullion or transom front ızalator (pvc)	6 m	
F0505		Taşıyıcı ön ızalasyon (pvc) Mullion or transom front ızalator (pvc)	118 m	
F0506		Taşıyıcı ön ızalasyon (pvc) Mullion or transom front ızalator (pvc)	134 m	

ÇT94
ÇELİK TAKVİYELİ CEPHE
STEEL REINFORCED FACADE

Pvc ızalasyon listesi
Pvc ızalator list

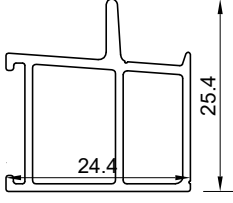
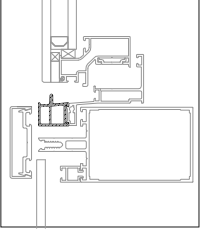
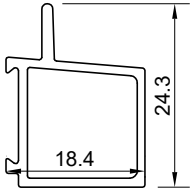
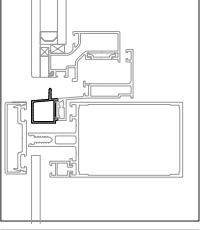
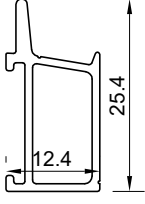
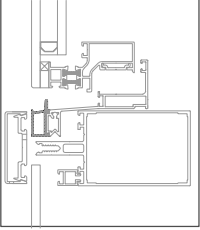
kod code	şekil drawing	tanım description	metraji metre / package	kullanım yeri aplication
F0520		Kasa profili ızalasyon (pvc) Frame profile ızalator (pvc)	170 m	
F0521		Kasa profili ızalasyon (pvc) Frame profile ızalator (pvc)	126 m	
F0522		Kasa profili ızalasyon (pvc) Frame profile ızalator (pvc)	106 m	

ÇT94
ÇELİK TAKVİYELİ CEPHE
STEEL REINFORCED FAÇADE

İMALAT ŞEMASI
PRODUCTION PLAN

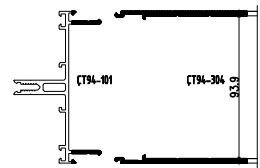
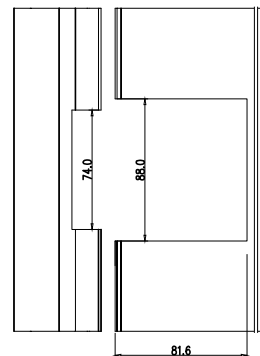
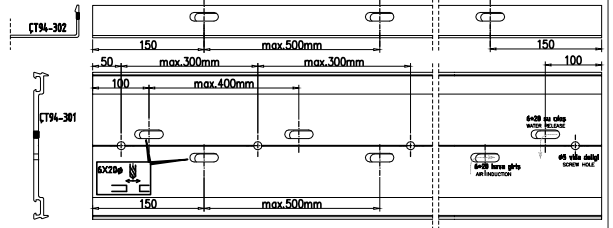
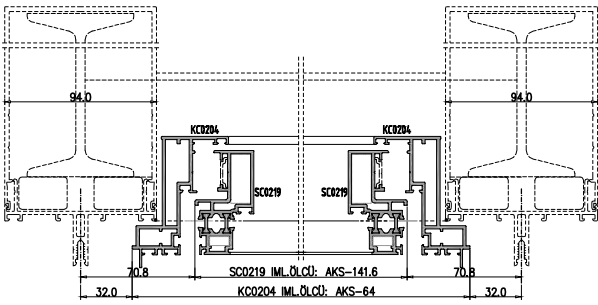
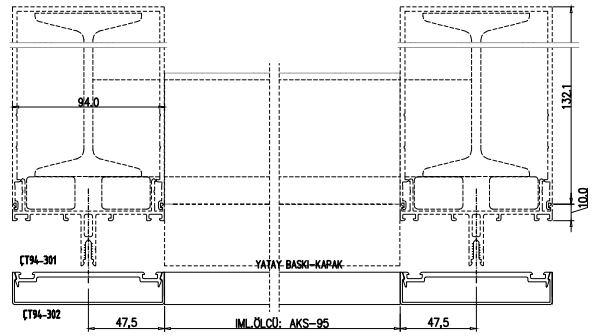
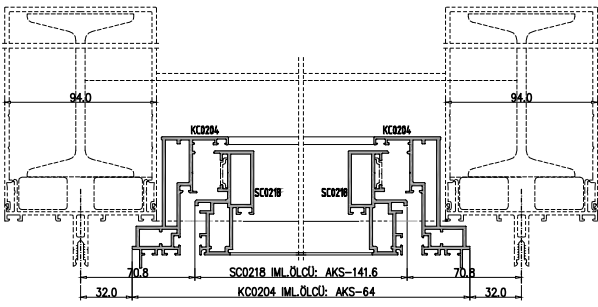
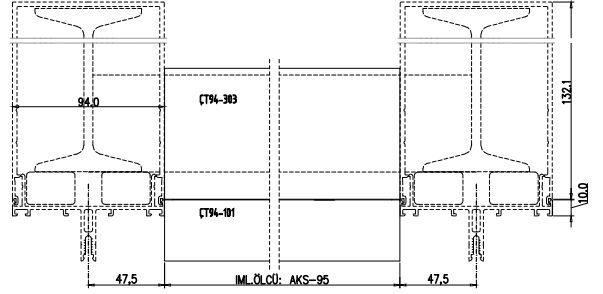
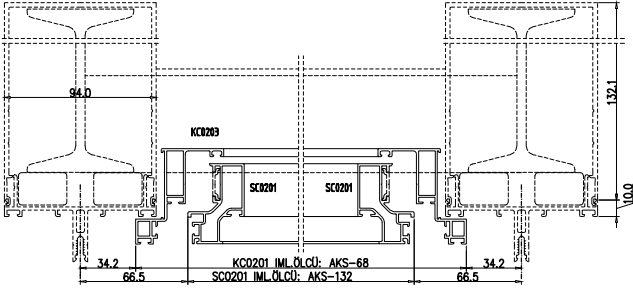

ÇT94

ÇELİK TAKVİYELİ CEPHE

STEEL REINFORCED FAÇADE

AKSESUARLAR
ACCESSOIRES

YÜKSEKLİĞE VE AĞIRLIĞA GÖRE MAXIMUM KANAT GENİSLİKLERİ
WIDTH ACCORDING TO THE WEIGHT AND THE HEIGHT

max. en boy ölçüsü

Tablodaki değerler ithal için geçerlidir.
All values are just for import

(20kg-50kg)

h/kg	20 kg	25 kg	30 kg	35 kg	40 kg	45 kg	50 kg
450	1500	1500	1500	1500	1500	1500	1500
500	1500	1500	1500	1500	1500	1500	1500
550	1500	1500	1500	1500	1500	1500	1500
600	1500	1500	1500	1500	1500	1500	1400
650	1500	1500	1500	1500	1500	1400	1292
700	1500	1500	1500	1500	1400	1300	1200
750	1500	1500	1500	1400	1307	1213	1120

w = 23 mm
l = 2615 mm
degree of opening 35°

h/kg	80 kg	90 kg	100 kg	110 kg	120 kg	130 kg	135 kg
700	1875	1875	1875	1875	1875	1875	1875
800	1875	1875	1875	1875	1875	1875	1875
900	1875	1875	1875	1875	1875	1875	1875
1000	1875	1875	1875	1875	1875	1875	1875
1100	1875	1875	1875	1875	1875	1875	1875
1200	1875	1875	1875	1875	1875	1875	1875
1300	1875	1875	1875	1875	1875	1875	1846
1400	1875	1875	1875	1875	1875	1789	1714
1500	1875	1875	1875	1875	1810	1566	1600
1600	1875	1875	1875	1829	1697	1875	1500
1700	1875	1875	1845	1721	1597	1474	1412

w = 23 mm
l = 5115 mm
degree of opening 25°

(30kg-60kg)

h/kg	30 kg	35 kg	40 kg	45 kg	50 kg	55 kg	60 kg
500	1500	1500	1500	1500	1500	1500	1500
550	1500	1500	1500	1500	1500	1500	1500
600	1500	1500	1500	1500	1500	1500	1500
650	1500	1500	1500	1500	1500	1500	1477
700	1500	1500	1500	1500	1500	1472	1371
750	1500	1500	1500	1500	1467	1373	1280
800	1500	1500	1500	1463	1375	1288	1200
850	1500	1500	1459	1400	1294	1212	1129

w = 23 mm
l = 3175 mm
degree of opening 35°

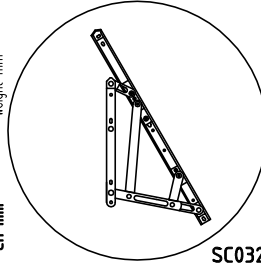

(35kg-69,5kg)

h/kg	35 kg	40 kg	45 kg	50 kg	55 kg	60 kg	65 kg	69 kg
550	1625	1625	1625	1625	1625	1625	1625	1625
600	1625	1625	1625	1625	1625	1625	1625	1625
650	1625	1625	1625	1625	1625	1625	1625	1625
700	1625	1625	1625	1625	1625	1625	1625	1625
750	1625	1625	1625	1625	1625	1625	1625	1625
800	1625	1625	1625	1625	1625	1625	1625	1625
850	1625	1625	1625	1625	1625	1604	1529	
900	1625	1625	1625	1625	1604	1514	1444	
950	1625	1625	1625	1582	1514	1435	1368	
1000	1625	1625	1625	1573	1503	1363	1300	
1050	1625	1625	1565	1498	1432	1298	1238	

w = 23 mm
l = 3535 mm
degree of opening 35°

h/kg	90 kg	100 kg	110 kg	120 kg	130 kg	137 kg
750	1875	1875	1875	1875	1875	1875
900	1875	1875	1875	1875	1875	1875
1000	1875	1875	1875	1875	1875	1875
1100	1875	1875	1875	1875	1875	1875
1200	1875	1875	1875	1875	1875	1875
1300	1875	1875	1875	1875	1875	1875
1400	1875	1875	1875	1875	1875	1821
1500	1875	1875	1875	1875	1798	1700
1600	1875	1875	1875	1817	1686	1594
1700	1875	1875	1834	1710	1587	1500
1800	1875	1875	1734	1610	1498	1417

w = 23 mm
l = 5565 mm
degree of opening 25°

(45kg-88,5kg)

h/kg	45 kg	50 kg	55 kg	60 kg	65 kg	70 kg	75 kg	80 kg	85 kg	88,5kg
600	1750	1750	1750	1750	1750	1750	1750	1750	1750	1750
650	1750	1750	1750	1750	1750	1750	1750	1750	1750	1750
700	1750	1750	1750	1750	1750	1750	1750	1750	1750	1750
750	1750	1750	1750	1750	1750	1750	1750	1750	1750	1750
800	1750	1750	1750	1750	1750	1750	1750	1750	1750	1750
850	1750	1750	1750	1750	1750	1750	1750	1750	1750	1750
900	1750	1750	1750	1750	1750	1750	1750	1750	1750	1750
950	1750	1750	1750	1750	1750	1750	1750	1750	1750	1750
1000	1750	1750	1750	1750	1750	1750	1750	1750	1739	1680
1050	1750	1750	1750	1750	1750	1750	1750	1738	1657	1600
1100	1750	1750	1750	1750	1750	1736	1659	1581	1527	
1150	1750	1750	1750	1750	1734	1660	1586	1513	1461	
1200	1750	1750	1750	1733	1662	1591	1520	1450	1400	
1250	1750	1750	1731	1663	1595	1528	1460	1392	1344	
1300	1750	1750	1730	1665	1560	1534	1470	1403	1338	1292

w = 23 mm
l = 4145 mm
degree of opening 30°

h/kg	90 kg	100 kg	110 kg	120 kg	130 kg	139 kg
800	1875	1875	1875	1875	1875	1875
950	1875	1875	1875	1875	1875	1875
1100	1875	1875	1875	1875	1875	1875
1200	1875	1875	1875	1875	1875	1875
1300	1875	1875	1875	1875	1875	1875
1400	1875	1875	1875	1875	1875	1875
1500	1875	1875	1875	1875	1875	1800
1600	1875	1875	1875	1875	1806	1688
1700	1875	1875	1875	1823	1700	1588
1800	1875	1875	1839	1722	1605	1500
1900	1875	1875	1742	1631	1521	1421

w = 23 mm
l = 6025 mm
degree of opening 25°

(55kg-102kg)

h/kg	55 kg	60 kg	65 kg	70 kg	75 kg	80 kg	85 kg	90 kg	95 kg	102 kg
650	1750	1750	1750	1750	1750	1750	1750	1750	1750	1750
750	1750	1750	1750	1750	1750	1750	1750	1750	1750	1750
850	1750	1750	1750	1750	1750	1750	1750	1750	1750	1750
950	1750	1750	1750	1750	1750	1750	1750	1750	1750	1750
850	1750	1750	1750	1750	1750	1750	1750	1750	1750	1750
1050	1750	1750	1750	1750	1750	1750	1750	1750	1750	1704
1150	1750	1750	1750	1750	1750	1750	1731	1663	1568	
1250	1750	1750	1750	1750	1729	1666	1603	1540	1452	
1350	1750	1750	1750	1728	1667	1606	1546	1485	1400	
1450	1750	1750	1750	1727	1668	1610	1551	1492	1434	1352
1500	1750	1750	1750	1669	1613	1556	1499	1443	1386	1307

w = 23 mm
l = 4585 mm
degree of opening 30°

(90kg-137kg)

h/kg	105 kg	115 kg	125 kg	135 kg	145 kg	155 kg
900	1875	1875	1875	1875	1875	1875
1100	1875	1875	1875	1875	1875	1875
1300	1875	1875	1875	1875	1875	1875
1500	1875	1875	1875	1875	1875	1875
1600	1875	1875	1875	1875	1875	1875
1700	1875	1875	1875	1875	1875	1765
1800	1875	1875	1875	1875	1816	1667
1900	1875	1875	1875	1863	1721	1579
2000	1875	1875	1875	1770	1635	1500
2100	1875	1875	1814	1685	1557	1429

w = 23 mm
l = 7075 mm
degree of opening 20°

ÇT94
ÇELİK TAKVİYELİ CEPHE
STEEL REINFORCED FAÇADE

AKSESUARLAR
ACCESSOIRES

DALDIRMA GALVENİZLİ SABİT U ANKRAJ (YATAY BAKLALI)
DIP GALVANIZED FIX "U" ANCHOR (HORIZONTAL)

- SC0338-2 (yerli) (native) L= 80 mm
SC0339-2 (yerli) (native) L= 100 mm
SC0340-2 (yerli) (native) L= 120 mm
SC0341-2 (yerli) (native) L= 150 mm
SC0342-2 (yerli) (native) L= 200 mm

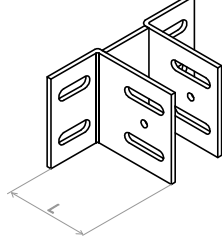

DALDIRMA GALVENİZLİ SABİT U ANKRAJ (DÜŞEY BAKLALI)
DIP GALVANIZED FIX "U" ANCHOR (VERTICAL)

- SC0338-1 (yerli) (native) L= 80 mm
SC0339-1 (yerli) (native) L= 100 mm
SC0340-1 (yerli) (native) L= 120 mm
SC0341-1 (yerli) (native) L= 150 mm
SC0342-1 (yerli) (native) L= 200 mm

