



Naturalbond 40+40|50+50

Alüminyum Kompozit Panel Renk Kartelası
Aluminium Composite Panel Color Chart

Alüminyum Kompozit Panel Renk Kartelası
Aluminium Composite Panel Color Chart



ALÜMİNYUM KOMPOZİT PANEL

1990'dan bu yana sektördeki birçok ilke imza atan **ASAŞ**, 2006 yılında Türkiye'deki ilk alüminyum kompozit panel üretim tesisini kurarak yeniliklerin Türkiye'ye kazandırılmasında öncü bir rol üstlenmenin gururunu taşımaktadır. Sektörün **hem ilk yerli hem de lider ürünü** olan kompozit panel ürünlerimiz farklı desen ve renk seçeneklerinin yanı sıra dünya standartlarında yüksek kalitesi, dayanıklılığı, kolay işlenebilmesi, yüzey düzgünlüğü, hafifliği ve geniş ürün yelpazesıyla en çok tercih edilen inşaat, dekorasyon, mobilya ve reklam ürünleri arasındadır. Kompozit panel üretim tesisi, bünyesinde bulunan 4 hat ile yılda 7.500.000m² alüminyum kompozit panel üretim kapasitesi ile hizmet vermektedir. Alüminyum kompozit panellerin üretiminde kullanılan boyalı alüminyum levhalar, 2014 yılında kurulan son teknoloji ile donatılmış **ASAŞ** Yassı Mamuller Üretim Tesisinde müşterilerimizin ihtiyaç ve beklentilerine uygun olarak üretilmektedir.

İleri teknolojinin kullanıldığı tesiste; farklı ölçü ve geniş renk yelpazesi ile konvansiyonel düşük yoğunluklu polietilen dolgulu alüminyum kompozit panellerin yanı sıra, alüminyum hidroksit dolgulu ve yangına dayanıklı özel alüminyum kompozit paneller üretilmektedir.

Tüm ürünler, ileri teknoloji ile donatılmış laboratuvarlarda kalite mühendislerince test edilmekte, uluslararası kalite standartlarına uygun olarak müşterilere sunulmaktadır.

ALUMINIUM COMPOSITE PANEL

ASAŞ which has been a trendsetter in the industry many times since 1990, is also proud to be a pioneer by founding the first composite panel production facility in Turkey in 2006. Our composite panel products are **the first native and leader ones** in the industry thanks to its various design & color options, highest quality standards, durability, easy processability, smooth finishing, lightness and wide range of products. They are amongst the most preferred products by construction, decoration, furniture and advertisement industries. The composite panel production facility operates with 4 lines and has the capacity of 7.500.000m² aluminium composite panel production. Painted aluminium sheets used in the production of aluminium composite panel are produced according to the needs and expectations of our customers in our **ASAŞ** Flat Rolled Products Production Facility which is founded in 2014.

Thanks to our high technology facility, both aluminium composite panels with various dimensions and colors which are filled with low dense polyethylene and non-flammable custom composite panels which are filled with aluminium hydroxide can be produced.

All products are tested in the labs with the most modern equipments by quality engineers and served to our customers only after meeting the international quality standards.

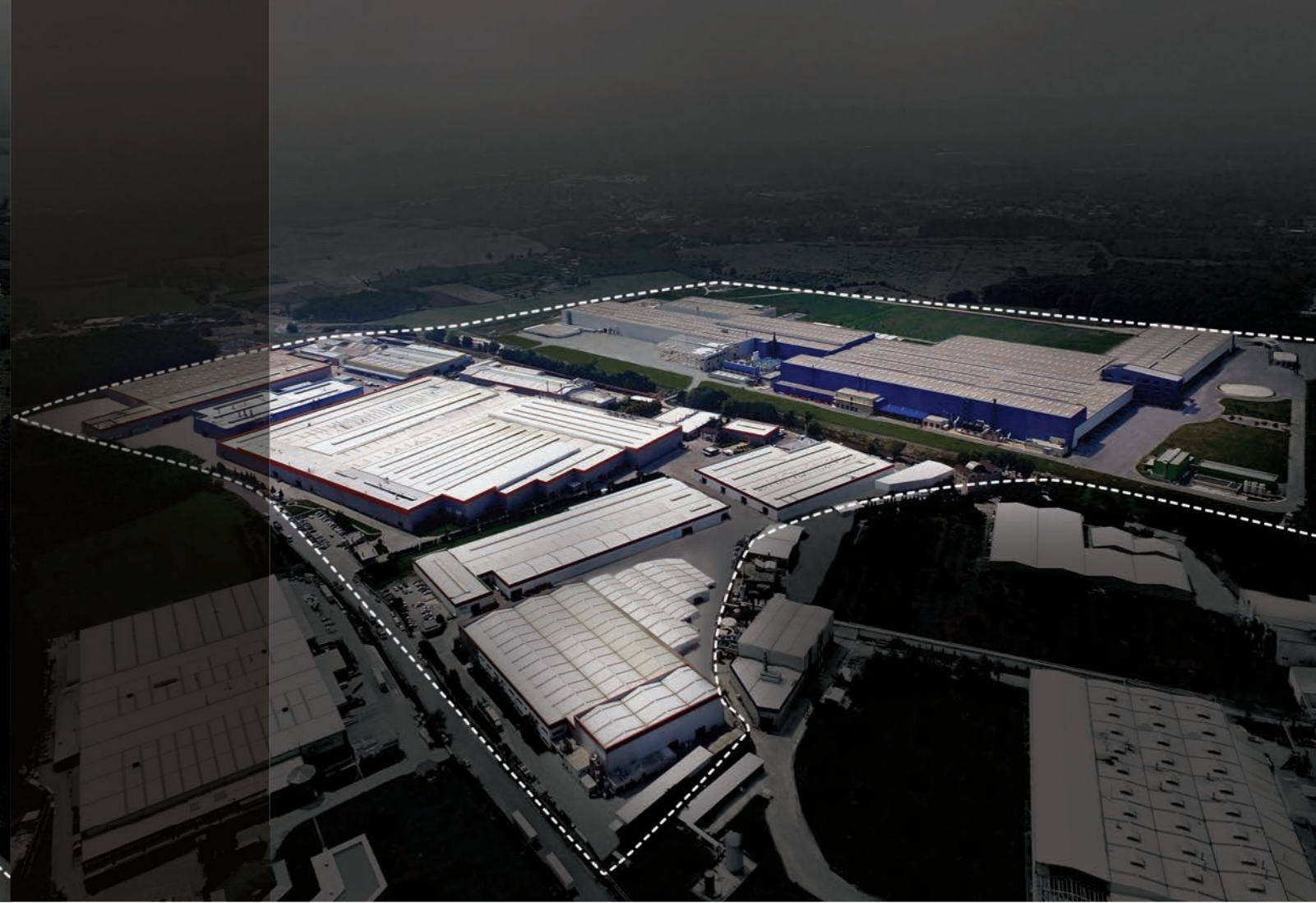

ASAŞ

Kurulduğu 1990 yılından beri istikrarlı büyüme trendi ile Türkiye’de İSO 500’de ilk 100 şirket arasında yer alan, aynı zamanda Avrupa’daki lider üreticilerden biri olan **ASAŞ**; 80’i aşkın ülkeye ihracat yapmakta, grup bünyesinde 2400’den fazla çalışanı ile Sakarya’da 300.000m² alanı kapalı olmak üzere; toplamda 750.000m² bir alanda, en modern teknoloji ile donatılmış tesislerinde üretim faaliyetlerini yürütmektedir.

ASAŞ çok sayıda başarılı iş birimlerini ve üretim tesislerini tek çatı altında bulundurmaktadır:

- Alüminyum Ekstrüzyon (Eloksallı, Elektrostatik Toz Boyalı, Mekanik İşlemlenmiş Profiller)
- Alüminyum Yassı Mamuller (Levha, Rulo, Folyo, Boyalı Rulo)
- Alüminyum Mimari Sistemler
- Alüminyum Kompozit Panel (Giydirme, Cephe, Cephe Kaplaması ve Reklam Uygulamaları)
- PVC Kapı ve Pencere Sistemleri
- Panjur ve Kepek Sistemleri
- Alüminyum Tasarım Ürünleri (Bayrak Direkleri, Aydınlatma Direkleri, Raf Sistemleri)
- ASAŞSANAT (Sanatçılar, Akademisyen ve Öğrenciler için yaratıcı bir platform)

ASAŞ

Since its founding in 1990, **ASAŞ** has grown steadily and ranked among Turkey’s Top 100 Industrial Companies List and one of Europe’s leading manufacturing companies. **ASAŞ** is currently; exporting to over 80 countries, employing over 2400 highly skilled people across the group and operates in a 750.000m² site in Sakarya / Turkey, of which 300.000m² is closed and equipped with the latest technology.

ASAŞ currently includes a number of highly successful business units and production facilities under the same roof:

- Aluminium Extrusion (Mechanically Processed Profiles with Anodising, Electrostatic Powder Paint)
- Aluminium Flat Products (Sheet, Roll, Foil, Painted Roll)
- Aluminium Architectural Systems
- Aluminium Composite Panel (Cladding, Facade, Facade Lining and Advertisement Applications)
- PVC Door and Window Systems
- Roller Shutter and Steel Shutter Systems
- Aluminium Design Products (Flag Poles, Lighting Poles, Shelf Systems)
- ASAŞSANAT (A Creative Platform for Artists, Academicians and Students)

AVANTAJLARI

- Estetik ve pürüzsüz yapısı sayesinde şık bir görünüm sağlar.
- Kullanımı kolaydır. Tercihe bağlı olarak levhaya istenilen şeklin verilmesi ve levhanın istenilen ebatlara getirilmesi mümkündür.
- Çeşitli renk ve boyutlarda temin edilebilmektedir.
- Dayanıklardır. Mukavim, hafif, rijit bir malzemedir.
- Koruyucudur. Hava etkilerine dayanımı sayesinde kapladığı alanı korur.
- Isı ve ses iletim katsayısı düşüktür.
- Ekonomiktir. Uygun fiyata tam koruma sağlar.
- İşleme kolaylığı, farklı renk alternatifleri ve mukavemeti sayesinde yaratıcılığınızı dilediğiniz gibi kullanmanızı sağlar.
- Uygulamada en iyi sonucu verir.

RENK SEÇENEKLERİ

ASAŞ alüminyum kompozit panel ürünleri; sipariş miktarına bağlı olarak her renkte üretilebilmektedir. Naturalbond markası altında düz renkler, metalik renkler, ahşap renkler, satine renkler ve prestij renkler gibi çeşitli seçenekler sunulmaktadır.

YANMAZLIK SINIFI

İleri teknolojinin kullanıldığı tesiste; farklı ölçü ve geniş renk yelpazesi ile konvansiyonel düşük yoğunluklu polietilen dolgulu alüminyum kompozit panellerin yanı sıra, alüminyum hidroksit dolgulu ve yangına dayanıklı özel alüminyum kompozit paneller üretilmektedir.

ASAŞ bünyesinde üretilen kompozit paneller; yüksek kaliteli PVDF boyalı alüminyum levha ve LDPE, Al(OH)₃ alüminyum hidroksit veya mineral dolgu kullanılarak TS EN 13501-1 standardı doğrultusunda B2, B1 veya A2 yanmazlık sınıfında, uluslararası inşaat sektörü gereksinimlerini üst düzeyde karşılayacak şekilde üretilmektedir.

GARANTİ

Tüm ürünler, ileri teknoloji ile donatılmış laboratuvarlarda kalite mühendislerince test edilmekte, uluslararası kalite standartlarına uygun olarak müşterilere sunulmaktadır. Boya türü, kalınlığı ve desen türüne bağlı olarak 20 yıla kadar garantisi bulunan Naturalbond, geniş ürün yelpazesiyle dünya standartlarında bina içi ve dış cepheler için estetik, fiziksel ve mekanik özelliklerin tümünü içeren önemli avantajları müşterilerine sunmaktadır.

(*) Naturalbond kompozit panel garanti koşulları, ASAŞ tarafından önerilen alüminyum alt konstrüksiyon ve montaj detaylarının kullanılması koşulu ile geçerlidir.

ÖNEMLİ

- Renk bütünlüğü sağlayabilmek için bir defada sipariş verilmesi önerilir.
- Lütfen kompozit panelleri ok yönünde kullanınız.
- Projelerinizde 1250mm ve 1500mm'lik levhalar birlikte kullanılacak ise sipariş aşamasında yazılı olarak bilgi verilmesi gerekmektedir.

ADVANTAGES

- It provides an elegant appearance due to its aesthetic and even surfaced structure.
- It is easy to use. It is possible to form the sheet according to desires and acquire the sheets in the desired dimensions.
- It can be supplied in various dimensions and colours.
- It is durable. It is a robust, light and rigid material.
- It is protective. It protects the surface it covers thanks to its resistance to the climatic conditions.
- It has a low coefficient of heat and noise transfer.
- It is economical. Provides full protection for a low price.
- It helps your creativity with its ease of forming, various colour alternatives and durability.
- Gives the best results in application.

COLOR OPTIONS

ASAŞ aluminum composite panel products; can be produced in every color depending on the order amount. The Naturalbond brand offers a wide range of options, including solid colors, metallic colors, wood colors, brush colors and prestige colors.

FIRE CLASSIFICATION

With a wide range of different dimensions and colors; conventional, low-intensity aluminium composite panels with polyethylene filling, and fire-resistant aluminium composite panels with aluminium hydroxide filling are produced in the facility which is equipped by advanced technology.

Composite panels are produced at ASAŞ in the highest international construction sector requirements in accordance with TS EN 13501 standard, by using high quality PVDF painted aluminium coil and LDPE resin, Al(OH)₃ aluminium hydroxide and mineral filling raw materials that are used in B2, B1, A2 classified products.

GUARANTEE

All products are tested by quality engineers at the state-of-the-art laboratories, and presented to clients in accordance with international quality standards. With a wide range of products, Naturalbond provides its clients significant benefits that include all aesthetic, physical and mechanical properties in world standards for interior and exterior building facades having up to 20 years guarantee depending on its paint type, thickness and design type.

(*)Naturalbond composite panels warranty conditions are valid as long as the aluminium bottom construction and the assembling directions are practised as advised by ASAŞ.

IMPORTANT

- To ensure the color consistency, placing total requirement in one order is recommended.
- Please applicate all the panels the arrow direction.
- Placing an order consist of different panel widths like 1250mm, 1500mm which will be used in the same project, please contact our sales representative.

NATURALBOND B2

A2
FR
50+50

Alüminyum Üst Levha Kalınlığı / Aluminium Top Sheet Thickness: 0,5mm
Alüminyum Alt Levha Kalınlığı / Aluminium Bottom Sheet Thickness: 0,5mm

Kompozit Panel Katmanları / Composite Panel Layers

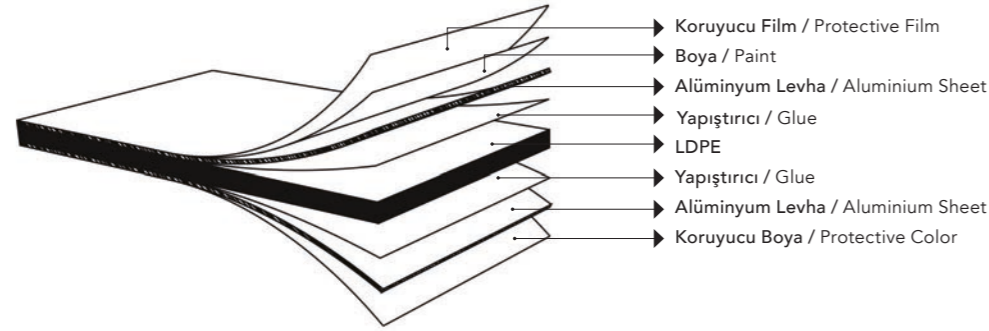

Teknik Bilgiler / Technical Specifications

Standart 4mm kalınlığındaki Naturalbond 50+50 kompozit panel için /
 For standard 4mm thick Naturalbond 50+50 composite panel:

Levha Alaşım - Kondisyon / Sheet Alloy - Condition	: EN AW-3105 / H46
Alüminyum Levha Kalınlık / Aluminium Sheet Thickness	: Üst Levha / Top Sheet: 0,50mm (±0,02mm) Alt Levha / Bottom Sheet: 0,50mm (±0,02mm)
Kompozit Panel Toplam Kalınlık / Composite Panel Total Thickness	: 4mm (±0,2mm)
Dolgu / Filling	: Yangın Tepki Sınıfına Göre Değişken - Kalınlık: 3mm Depending On The Flammability Class - Thickness: 3mm
Üst Levha Kaplama / Top Sheet Coating	: Boya (20+5 mikron) Paint (20+5 micron)
Alt Levha / Bottom Sheet	: Polyester Bazlı Koruyucu Boya / Polyester Based Protective Paint

Yanmazlık Sınıfı / Non-flammability Class

Ürün Adı Product Name	Dolgu Malzemesi Filling Material	DIN 4102 Yangın Tepki Sınıfı Flammability Class	TS EN 13501-1 Yangın Tepki Sınıfı Flammability Class
Naturalbond 50+50	LDPE	B2	D-s1,d0
Naturalbond 50+50	LDPE+AL(OH)	B1 (FR)	B-s1,d1
Naturalbond 50+50	Mineral Dolgu	A2	A2-s1,d0

Ürün Çeşitleri / Types of Products

Kompozit Panel Kalınlığı / Composite Panel Thickness	: 3mm - 6mm (EN 485-4)
Kompozit Panel Geniřliđi / Composite Panel Width	: 1250mm, 1500mm
Maksimum Üretim Uzunluđu / Maximum Production Length	: 6000mm
Standart Üretim Ölçüleri / Standard Production Measurements	: 1250mm x 3200mm : 1500mm x 3200mm

Üretim Toleransları / Tolerances on Production

Kompozit Panel Kalınlığı / Composite Panel Thickness	: ±0,2mm
Kompozit Panel Geniřliđi / Composite Panel Width	: -0mm / +2,0mm
Kompozit Panel Uzunluđu / Composite Panel Length	: -0mm / +4,0mm
Diyagonal Fark / Diagonal Difference	: max. 3,0mm
Dođrusallık (Geniřlik ve Uzunluk) / Linearity (Width and Length)	: ±0,2mm
Eđiklik / Inclination	: max 5mm (Panel uzunluđu / Panel length < 1500mm) max 7mm (Panel uzunluđu / Panel length: 1500mm - 30000mm)

Panel Deformasyon Risk Tablosu / Risk Table for Panel Deformation

Rüzgar Yüğü Wind Load (Kpa)	Panel Ebatları / Panel Dimensions (mm)										Deformasyon / Deformation % Risk / % of Risk
	En Width	Boy Length	600	900	1200	1500	1800	2100	2400	2700	
51	900		11%	19%	24%	26%	27%	27%	28%	28%	28%
	1200		21%	41%	51%	57%	61%	63%	66%	67%	69%
	1500		38%	69%	84%	92%	97%	100%	103%	105%	107%
102	900		22%	36%	43%	47%	49%	51%	52%	52%	53%
	1200		44%	46%	83%	89%	95%	98%	102%	104%	106%
	1500		79%	115%	129%	135%	140%	144%	147%	150%	152%
151	900		41%	57%	74%	88%	91%	92%	94%	96%	97%
	1200		62%	74%	96%	107%	109%	111%	111%	111%	112%
	1500		95%	105%	120%	129%	130%	131%	135%	137%	137%
202	900		44%	63%	71%	77%	82%	85%	88%	89%	90%
	1200		87%	114%	126%	132%	138%	142%	147%	149%	149%
	1500		145%	174%	185%	190%	194%	197%	201%	203%	205%
252	900		55%	96%	118%	128%	134%	136%	138%	138%	139%
	1200		106%	204%	256%	284%	304%	317%	329%	336%	343%
	1500		189%	347%	422%	458%	483%	500%	517%	527%	535%

Yeşil: İdeal kullanılabilir / Green: Can be used as ideal
 Sarı: Tekrar kontrol edilmeli (statik hesap yapılmalı) / Yellow: Should be recontrolled. (Static calculation is needed)
 Siyah: Takviye olmadan kullanılamaz / Black: Can't be used without reinforcement

NATURALBOND ^{FR} B2

40+40

Alüminyum Üst Levha Kalınlığı / Aluminium Top Sheet Thickness: 0,4mm
Alüminyum Alt Levha Kalınlığı / Aluminium Bottom Sheet Thickness: 0,4mm

Kompozit Panel Katmanları / Composite Panel Layers

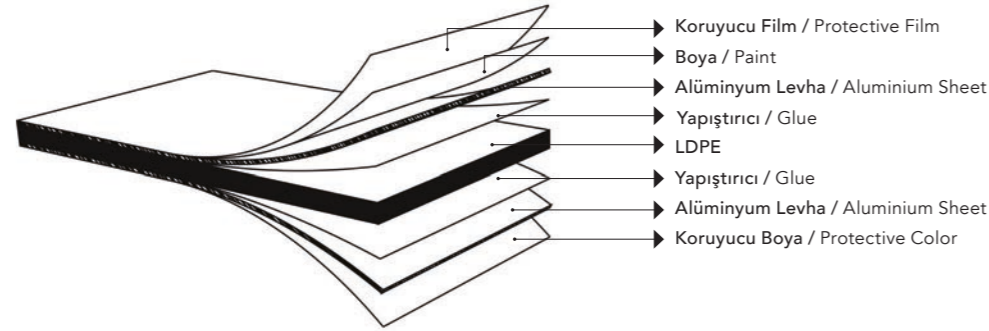

Teknik Bilgiler / Technical Specifications

Standart 4mm kalınlığındaki Naturalbond 40+40 kompozit panel için /
 For standard 4mm thick Naturalbond 40+40 composite panel:

Levha Alaşım - Kondisyon / Sheet Alloy - Condition	: EN AW-3105 / H46
Alüminyum Levha Kalınlık / Aluminium Sheet Thickness	: Üst Levha / Top Sheet: 0,40mm (±0,02mm) Alt Levha / Bottom Sheet: 0,40mm (±0,02mm)
Kompozit Panel Toplam Kalınlık / Composite Panel Total Thickness	: 4mm (±0,2mm)
Dolgu / Filling	: Yangın Tepki Sınıfına Göre Değişken - Kalınlık: 3,2mm Depending On The Flammability Class - Thickness: 3,2mm
Üst Levha Kaplama / Top Sheet Coating	: Boya (20+5 mikron) Paint (20+5 micron)
Alt Levha / Bottom Sheet	: Polyester Bazlı Koruyucu Boya / Polyester Based Protective Paint

Yanmazlık Sınıfı / Non-flammability Class

Ürün Adı Product Name	Dolgu Malzemesi Filling Material	DIN 4102 Yangın Tepki Sınıfı Flammability Class	TS EN 13501-1 Yangın Tepki Sınıfı Flammability Class
Naturalbond 40+40	LDPE	B2	D-s1,d0
Naturalbond 40+40	LDPE+AL(OH)	B1 (FR)	B-s1,d1

Ürün Çeşitleri / Types of Products

Kompozit Panel Kalınlığı / Composite Panel Thickness	: 3mm - 6mm (EN 485-4)
Kompozit Panel Geniřlięi / Composite Panel Width	: 1250mm, 1500mm
Maksimum Üretim Uzunluęu / Maximum Production Length	: 6000mm
Standart Üretim Ölçüleri / Standard Production Measurements	: 1250mm x 3200mm : 1500mm x 3200mm

Üretim toleransları / Tolerances on Production

Kompozit Panel Kalınlığı / Composite Panel Thickness	: ±0,2mm
Kompozit Panel Geniřlięi / Composite Panel Width	: -0mm / +2,0mm
Kompozit Panel Uzunluęu / Composite Panel Length	: -0mm / +4,0mm
Diyagonal Fark / Diagonal Difference	: max. 3,0mm
Doęrusallık (Geniřlik ve Uzunluk) / Linearity (Width and Length)	: ±0,2mm
Eęiklik / Inclination	: max 5mm (Panel uzunluęu / Panel length < 1500mm) max 7mm (Panel uzunluęu / Panel length: 1500mm - 30000mm)

Panel Deformasyon Risk Tablosu / Risk Table for Panel Deformation

Rüzgar Yüğü Wind Load (Kpa)	Panel Ebatları / Panel Dimensions (mm)										Deformasyon / Deformation % Risk / % of Risk	
	En Width	Boy Length	600	900	1200	1500	1800	2100	2400	2700		3000
51	900		14%	22%	26%	28%	29%	30%	31%	31%	32%	
	1200		28%	42%	47%	50%	53%	55%	56%	57%	58%	
	1500		49%	66%	71%	74%	76%	77%	79%	80%	81%	
102	900		28%	44%	51%	56%	59%	60%	62%	63%	63%	
	1200		56%	84%	95%	101%	106%	109%	113%	115%	117%	
	1500		98%	131%	143%	148%	152%	155%	158%	160%	162%	
151	900		42%	60%	68%	73%	78%	80%	83%	83%	85%	
	1200		85%	83%	109%	119%	125%	131%	134%	138%	142%	
	1500		136%	165%	174%	186%	193%	202%	208%	211%	214%	
202	900		55%	73%	82%	88%	93%	96%	99%	100%	101%	
	1200		105%	129%	139%	145%	150%	153%	157%	159%	162%	
	1500		167%	191%	199%	203%	206%	209%	211%	213%	215%	
252	900		84%	120%	137%	147%	156%	161%	165%	167%	169%	
	1200		169%	165%	218%	239%	250%	261%	268%	276%	284%	
	1500		273%	329%	348%	371%	386%	403%	415%	423%	428%	

Yeşil: İdeal kullanılabilir / Green: Can be used as ideal
 Sarı: Tekrar kontrol edilmeli (statik hesap yapılmalı) / Yellow: Should be recontrolled. (Static calculation is needed)
 Siyah: Takviye olmadan kullanılamaz / Black: Can't be used without reinforcement

RENKLER / COLORS

RENKLER
COLORS

DÜZ RENKLER / SOLID COLORS

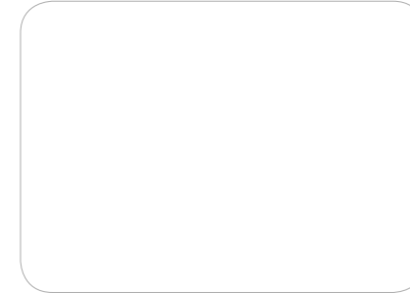

NB 901
Beyaz - Pure White

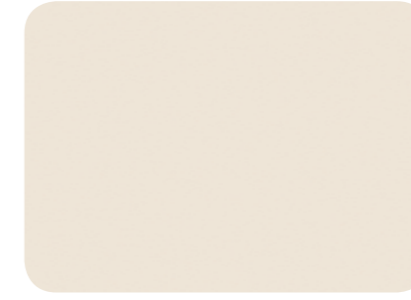

NB 912
Krem - Cream White

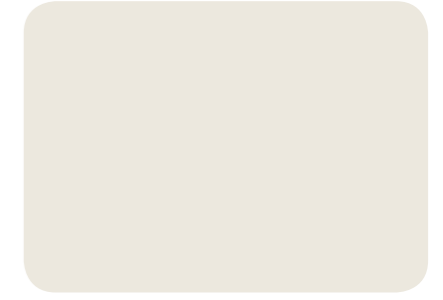

NB 104
İnci Beyaz - Pearl White

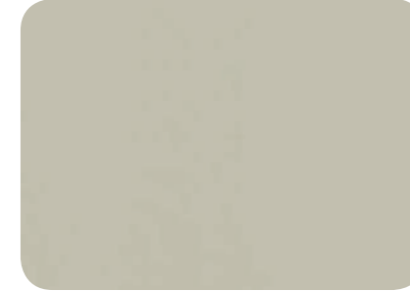

NB 604
Yeşil Gri - Grey Green

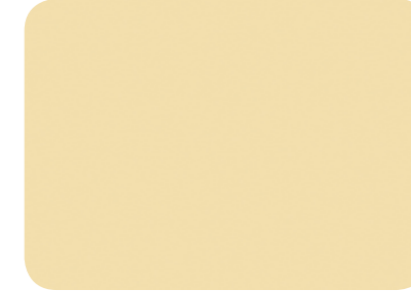

NB 101
Fildişi Bej - Ivory Sand

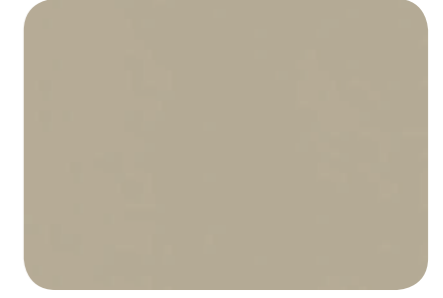

NB 107
Gri Bej - Grey Beige



NB 381
Açık Kahverengi - Pale Brown



NB 382
Toprak Kahve - Soil Brown



NB 505
Lacivert - Gentian Blue



NB 503
Deniz Mavisi - Ultramarine Blue



NB 504
Çelik Mavi - Steel Blue



NB 701
Platin Gri - Platinum Grey



NB 703
Grafit Gri - Graphite Grey



NB 951
Siyah - Graphite Black



NB 304
Şeker Pembe - Erika Violet

RENKLER / COLORS



DÜZ RENKLER / SOLID COLORS



NB 301
Bordo - Red Brown



NB 302
Kırmızı - Traffic Red



NB 202
Turuncu - Orange



NB 102
Sarı - Rape Yellow



NB 603
Yosun Yeşili - Moss Green



NB 203
Pantone Turuncu - Pantone Orange



NB 704
Füme - Smoked Grey



NB 705
Antrasit Gri - Antracite Grey



RENKLER / COLORS

METALİK RENKLER / METALLIC COLORS

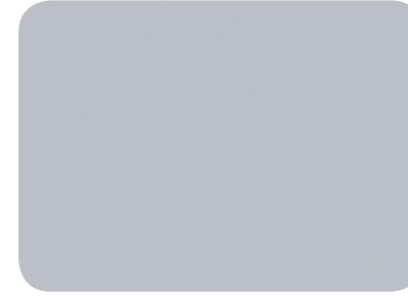

NB 090
Metalik Gümüş - Metallic Silver



NB 080
Açık Bronz - Lys Bronze



NB 011
Altın Sarısı - Pearl Gold

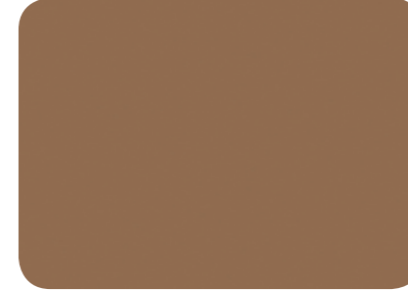

NB 081
Bakır - Copper



NB 050
Metalik Açık Mavi - Azul Blue

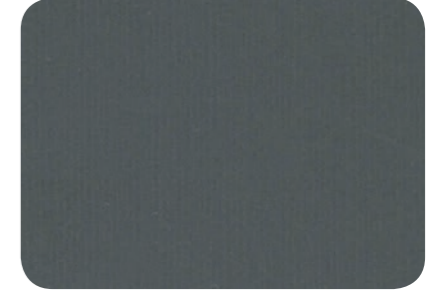

NB 702
Metalik Koyu Gri - Metallic Dark Grey

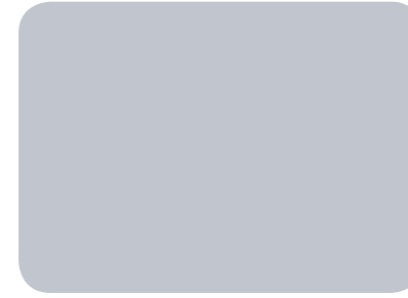

NB 092
Parlak Metalik Gümüş -
Shiny Metallic Silver

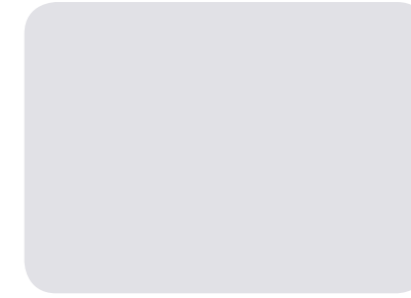

NB 095
Şampanya - Champagne



RENKLER / COLORS

AHŞAP RENKLER / WOOD COLORS



NB 874
Koyu Altın Meşe - Kiefer Line Wood

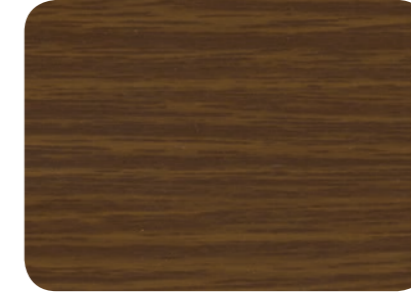

NB 857
Kalın Altın Meşe - Golden Oak Line Wood

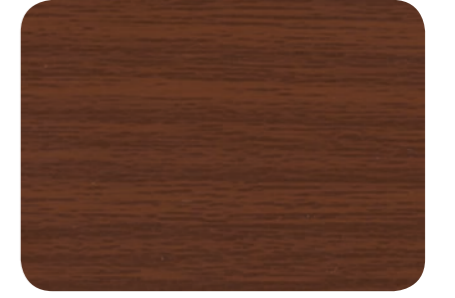

NB 872
Doğal Meşe - Natural Oak



NB 870
Açık Kiraz - Light Cherry



NB 871
Koyu Kiraz - Dark Cherry



NB 856
İnce Altın Meşe - Golden Oak Fine Wood

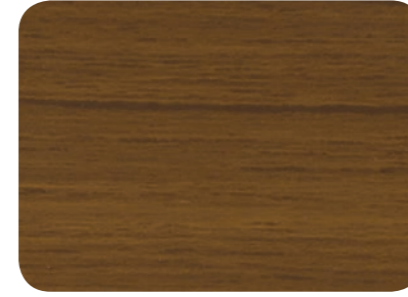

NB 876
Tik - Teak



NB 875
Afrika Tiki - African Teak

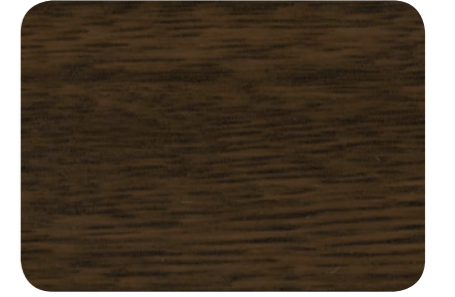

NB 859
İnce Ceviz - Nussbaum Fine Wood



NB 858
Kalın Maun - Mahogany

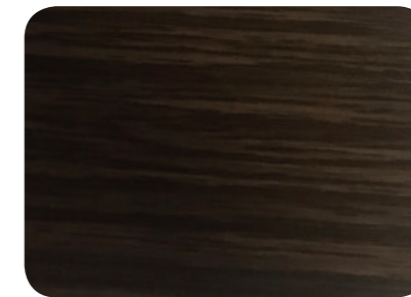

NB 895
Venge - Wenge Line

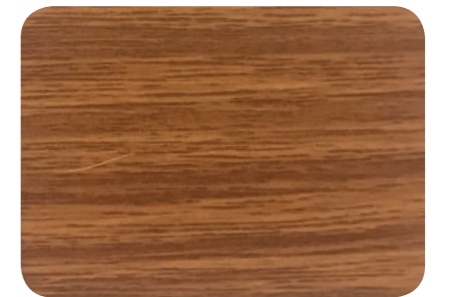

NB 896
Bambu - Cane Line

RENKLER / COLORS

PRESTİJ VE SİMLİ RENKLER / PRESTIGE AND SILVERY COLORS



NB 860
Parlak Metalik Gümüş Mavi -
Light Blue Metallic Silver

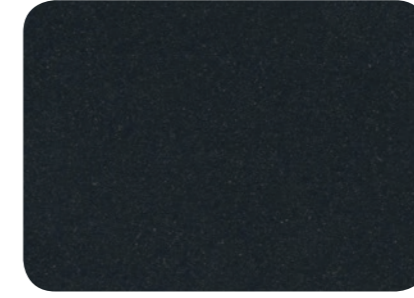

NB 861
Siyah Metalik - Black Metallic

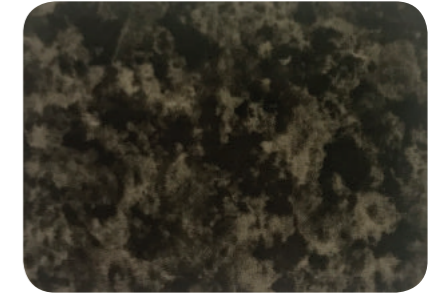

NB 890
Siyah Granit - Granite Black



NB 877
Satine Gümüş - Brush Silver



NB 878
Satine Bakır - Brush Copper

YENİ DESENLER / NEW PATTERNS



NB 961
Patina Bakır - Copper Patina

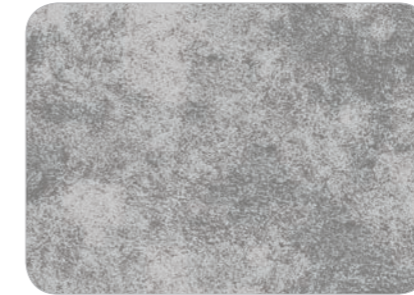

NB 960
Brüt Beton - Concrete

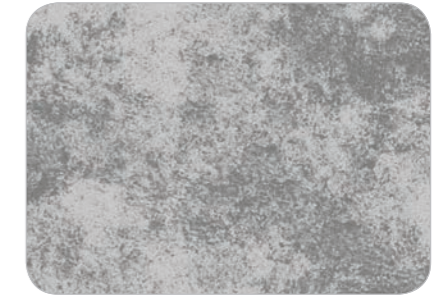

NB 962
Dokulu Brüt Beton - Textured Concrete

YÜZEY SEÇENEKLERİ / SURFACE OPTIONS

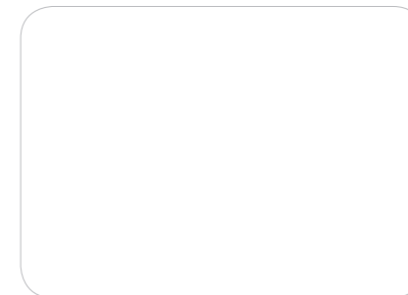

NB 905
Nano Beyaz - Nano White*

*Nano özelliği, sipariş miktarına göre tüm düz renkler için uygulanabilmektedir.
*Nano effect can be applied for all solid colors depending on the amount of the order.

GENEL ÖZELLİKLER / GENERAL FEATURES

İşlemler / Process

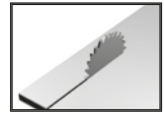

Kesme / Cutting

Kesme işlemi testere ya da oyma testere ile yapılabilmektedir. Oluk Açma: 90 derecelik bir köşe dönüşü için, 110 derecelik bir kertme bıçağıyla kertilmesi tavsiye edilmektedir. Kerterken dış kısımda 0.2~0.4mm 'lik çekirdek kısmın da kalmasına dikkat edilmelidir.

Cutting can be made through saw or fret saw. Opening grooves: For 90 degrees of corner return, it should be notched by a notching blade of 110 degrees as recommended. While notching, a nucleus part of 0.2 - 0.4mm is required to be left in the outer part.

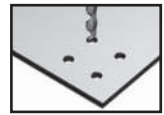

Delme / Boring

Bu işlem burgulu matkapla yapılır.

This process is to be made with twisted drill.



Kontur / Contour

Bu işlem oyma testere, kontur testeresi ve freze makinası ile yapılabilir.

This process is to be made by fret saw, contour saw and milling.

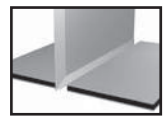

Biçme / Hewing

Bu işlem giyotin ile yapılabilir.

This process is to be made with guillotine.



Delme / Boring

Bu işlem delme makinası ile yapılabilir.

This process is to be made by boring machine.



Bükme / Bending

Bu işlem fren basınç aleti ve katlama tablası ile yapılabilir. 3mm ve 4mm için minimum bükülme yarıçapı tekli için 40mm, paralel için 50mm, 6mm için minimum bükülme yarıçapı tekli için 55mm, paralel için 80mm.

This process can be made by brake pressure device and folding table. For 3mm and 4mm, minimum bending radius is 40mm for single, 50mm for parallel; for 6mm, minimum bending radius is 55mm for single, 80mm for parallel.

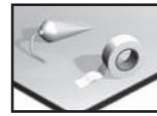

Yapıştırma / Sticking

Bu işlem metal yapıştırıcısı ile yapılabilir.

This process can be made by metal sticking.



Perçinleme / Riveting

Bu işlem perçin ile yapılabilir.

This process can be made by rivet.

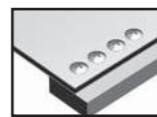

Vidalama / Screwing

Bu işlem metal vidalarla ile yapılabilir.

This process can be made by metal screws.



Kaynaklama / Welding

Bu işlem sıcak hava kaynağı ile yapılabilir.

This process can be made by hot air welding.

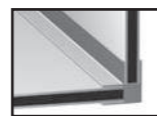

Kenetleme / Coupling

Bu işlem köşe birleştirici profiller ile yapılabilir.

This process can be made with corner assembling profiles.

ÜRÜN DETAYLARI / PRODUCT DETAILS

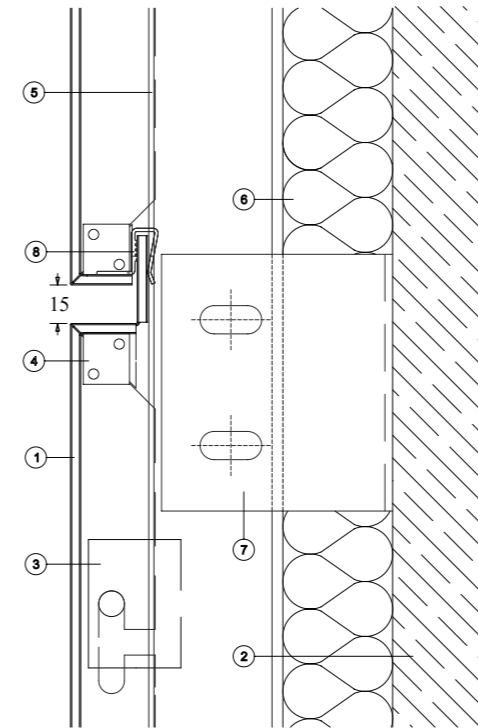

- 1 NATURALBOND
- 2 BETONARME / CONCRETE
- 3 ANAHTAR GEÇME BAĞLANTISI / COMPOSITE CONNECTING ANCHORAGE (08.01.04)
- 4 20X20X1.2mm ALÜMİNYUM KÖŞEBENT (163) / 20X20X1.2 MM ALUMINIUM PROFILE
- 5 ALÜMİNYUM DÜŞEY TAŞIYICI PROFİL (10634) / ALUMINIUM MULLION PROFILE (10634)
- 6 TAŞ YÜNÜ / ISOLATION
- 7 ALÜMİNYUM ANKRAJ / ALUMINIUM ANCHORAGE (08.01.03)
- 8 ALÜMİNYUM BAĞLANTI PROFİLİ / ALUMINIUM CONNECTING PROFILE (6773)
- 9 EPDM FİTİL / EPDM GASKET (01.07.10.50R)

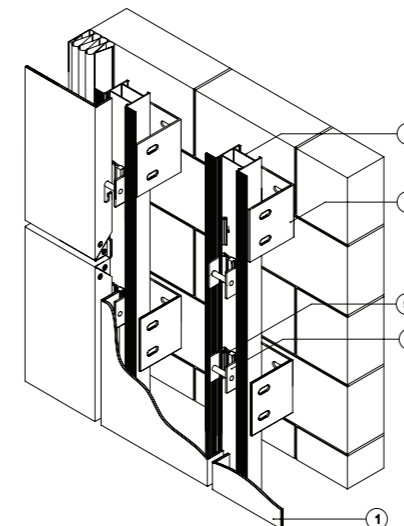
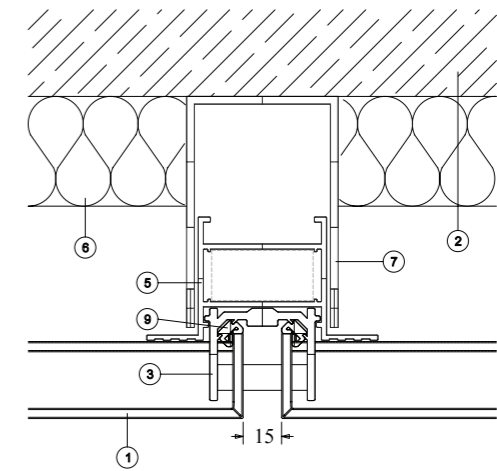

	ANAHTAR GEÇME BAĞLANTISI COMPOSITE CONNECTING ANCHORAGE (08.01.04)
	ALÜMİNYUM ANKRAJ ALUMINIUM ANCHORAGE (08.01.03)



ASAŞ Alüminyum Sanayi ve Ticaret A.Ş.

Genel Müdürlük / Headquarters

Rüzgarlı Bahçe Mah., Kumlu Sok., No: 2

Asaş İş Merkezi, 34810 Kavacık

Beykoz - İstanbul, Türkiye

T +90 216 680 07 80 **F** +90 216 680 07 81

Alüminyum Profil ve Kompozit Panel Üretim Tesisleri /

Aluminium Profile and Composite Panel Production Facilities

Küçücek İstiklal Mah., Kışla Alanı Cad.,

No: 2-2/1, 54400 Akyazı - Sakarya, Türkiye

T +90 264 462 47 92 **F** +90 264 462 47 96

asastr.com

2020-03