

1

2

3

4

5

6

7

8

9

10

11

12

13

14

15

16

17

18

19

20

21

22

23

24

25

26

27

28

29

## Rolforming Yöntemiyle Üretilmiş Alüminyum Profiller

### *Rollformed Aluminium Slats*

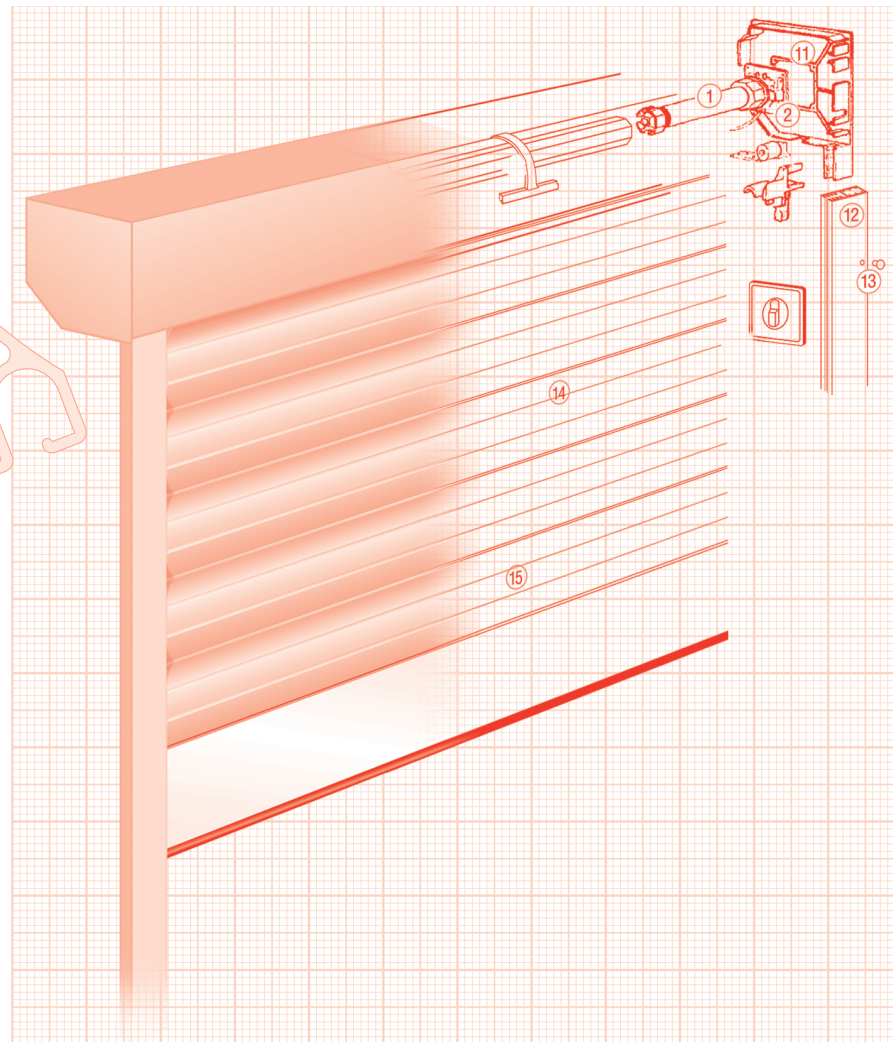
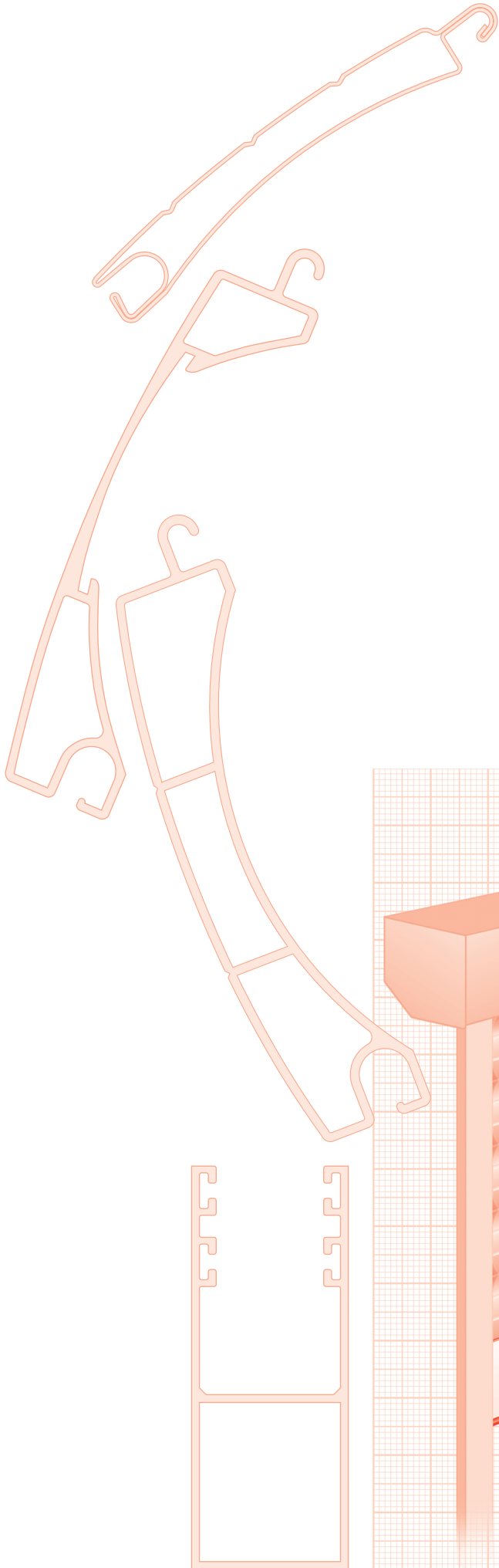

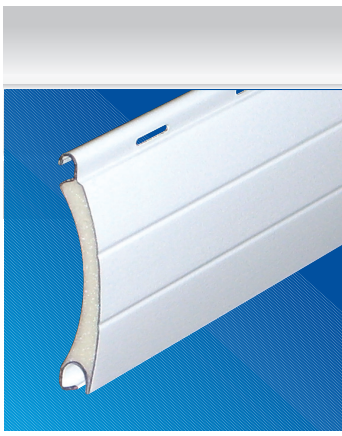

## ROLFORMİNG YÖNTEMİYLE ÜRETİLMİŞ ALÜMİNYUM PROFİLLER ROLLFORMED ALUMINIUM SLATS

ÜRÜN / ITEM	ÜRÜN ÖZELLİKLERİ	PRODUCT DESCRIPTION
	<b>SL-39 PROFİL</b> Poliüretan dolgulu, havalandırma delikli (AHO) veya deliksiz (AWH)	<b>SL-39 SLAT</b> With polyurethane foam insulation, perforated (AHO) or non perforated (AWH)
	Nominal kalınlık 8.9 mm Kapama yüzeyi 39 mm Ağırlık (m <sup>2</sup> ) ~ 2.51 kg max. kullanım ölçüleri 2,6 x 2 m 1 m yükseklikteki profil adedi 25.64 (slats)	Nominal thickness 8.9 mm Surface area 39 mm Weight per sqm. ~ 2.51 kg max. usage sizes 2,6 x 2 m No. of slats per 1 m height 25.64 (slats)
<b>AMBALAJ</b>	standart palet boyu 6.500 mm. 60 adetlik paketler halinde	
<b>PACKAGING</b>	bundles of 60 bars, standard length 6.500 mm	

### STANDART RENKLER STANDARD COLORS

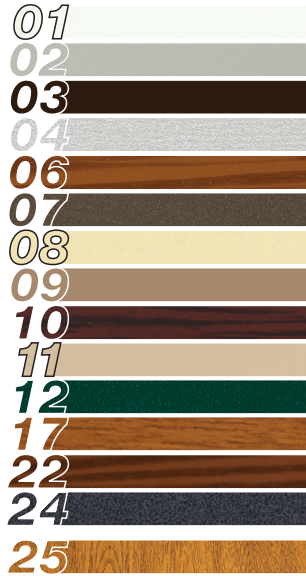

### ÖZEL RENKLER SPECIAL COLORS

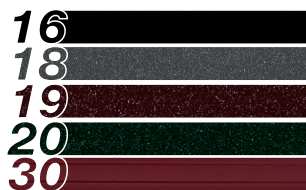

RAL NO	RENK	COLOR	ÜRÜN KODU / CODE
9016	Beyaz	White	SL.039.01.XXX
7038	Gri	Grey	SL.039.02.XXX
8014	Kahve	Brown	SL.039.03.XXX
9006	Metalik gri	Silver metallic	SL.039.04.XXX
-	Koyu ahşap	Dark wood	SL.039.06.XXX
-	Metalik Bronz	Metallic Bronze	SL.039.07.XXX
1015	Krem	Ivory	SL.039.08.XXX
-	Koyu bej	Dark beige	SL.039.09.XXX
-	Maun ahşap	Mahogany wood	SL.039.10.XXX
-	Açık bej	Light beige	SL.039.11.XXX
6005	Yosun yeşili	Moss green	SL.039.12.XXX
-	Altın meşe	Golden oak	SL.039.17.XXX
-	Fındık ahşap	Nussbaum wood	SL.039.22.XXX
7016	Koyu Gri (antrasit)	Dark Gray (anthracite)	SL.039.24.XXX
-	Ceviz ahşap	Walnut wood	SL.039.25.XXX
8022	Siyah	Black	SL.039.16.XXX
-	Kırçılı gri	Sprinkling grey	SL.039.18.XXX
-	Kırçılı bordo	Sprinkling red	SL.039.19.XXX
-	Kırçılı yeşil	Sprinkling green	SL.039.20.XXX
8019	Maun	Mahogany	SL.039.30.XXX



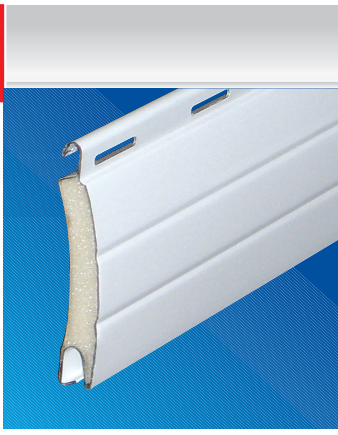

## ROLFORMİNG YÖNTEMİYLE ÜRETİLMİŞ ALÜMİNYUM PROFİLLER *ROLLFORMED ALUMINIUM SLATS*

ÜRÜN / ITEM	ÜRÜN ÖZELLİKLERİ		PRODUCT DESCRIPTION
	<b>SL-41 PROFİL</b> Poliüretan dolgulu, havalandırma delikli (AHO) veya deliksiz (AWH)		<b>SL-41 SLAT</b> <i>With polyurethane foam            insulation, perforated (AHO)            or non perforated (AWH)</i>
	Nominal kalınlık Kapama yüzeyi Ağırlık (m <sup>2</sup> ) max. kullanım ölçüleri 1 m yükseklikteki profil adedi Standart üretim uzunluğu	8.7 mm 41 mm ~ 2,98 kg 2,7 x 2 m 24.39 (slats) 6,5 m	
<b>AMBALAJ</b>	standart palet boyu 6.500 mm. 60 adetlik paketler halinde		
<b>PACKAGING</b>	<i>bundles of 60 bars, standard length 6.500 mm</i>		

### STANDART RENKLER STANDARD COLORS

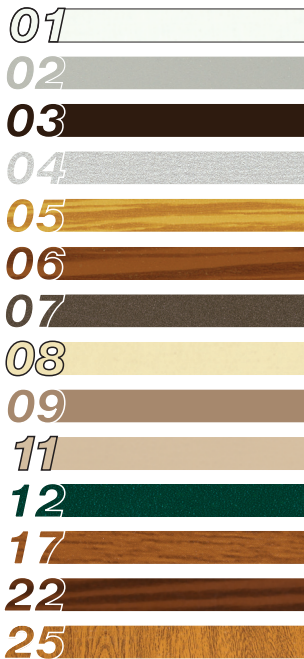

### ÖZEL RENKLER SPECIAL COLORS

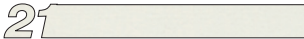

RAL NO	RENK	COLOR	ÜRÜN KODU / CODE
9016	Beyaz	<i>White</i>	SL.041.01.XXX
7038	Gri	<i>Grey</i>	SL.041.02.XXX
8014	Kahve	<i>Brown</i>	SL.041.03.XXX
9006	Metalik gri	<i>Silver metallic</i>	SL.041.04.XXX
-	Açık ahşap	<i>Light wood</i>	SL.041.05.XXX
-	Koyu ahşap	<i>Dark wood</i>	SL.041.06.XXX
-	Metalik Bronz	<i>Metallic Bronze</i>	SL.041.07.XXX
1015	Krem	<i>Ivory</i>	SL.041.08.XXX
-	Koyu bej	<i>Dark beige</i>	SL.041.09.XXX
-	Açık bej	<i>Light beige</i>	SL.041.11.XXX
6005	Yosun yeşili	<i>Moss green</i>	SL.041.12.XXX
-	Altın meşe	<i>Golden oak</i>	SL.041.17.XXX
-	Fındık ahşap	<i>Nussbaum wood</i>	SL.041.22.XXX
-	Ceviz ahşap	<i>Walnut wood</i>	SL.041.25.XXX
9010	Mat beyaz	<i>Off-white</i>	SL.041.21.XXX

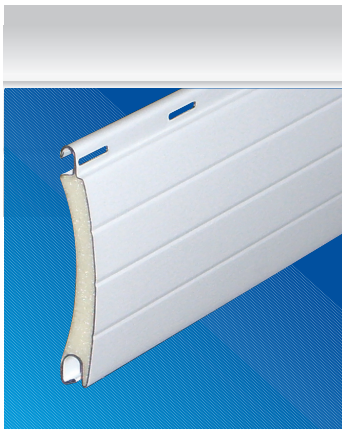

## ROLFORMİNG YÖNTEMİYLE ÜRETİLMİŞ ALÜMİNYUM PROFİLLER *ROLLFORMED ALUMINIUM SLATS*

ÜRÜN / ITEM	ÜRÜN ÖZELLİKLERİ		PRODUCT DESCRIPTION
	<b>SL-45 PROFİL</b> Poliüretan dolgulu, havalandırma delikli (AHO) veya deliksiz (AWH)		<b>SL-45 SLAT</b> With polyurethane foam insulation, perforated (AHO) or non perforated (AWH)
	Nominal kalınlık Kapama yüzeyi Ağırlık (m <sup>2</sup> ) max. kullanım ölçüleri 1 m yükseklikteki profil adedi Standart üretim uzunluğu	8.7 mm 45 mm ~ 2,71 kg 2,8 x 2 m 22,22 (slats) 6,5 m	
	<b>AMBALAJ</b>	standart palet boyu 6.500 mm. 60 adetlik paketler halinde	
	<b>PACKAGING</b>	bundles of 60 bars, standard length 6.500 mm	

### STANDART RENKLER STANDARD COLORS

01	
02	
03	
04	
05	
06	
07	
08	
09	
11	
12	
17	
22	
25	

### ÖZEL RENKLER SPECIAL COLORS

21	
----	--

RAL NO	RENK	COLOR	ÜRÜN KODU / CODE
9016	Beyaz	White	SL.045.01.XXX
7038	Gri	Grey	SL.045.02.XXX
8014	Kahve	Brown	SL.045.03.XXX
9006	Metalik gri	Silver metallic	SL.045.04.XXX
-	Açık ahşap	Light wood	SL.045.05.XXX
-	Koyu ahşap	Dark wood	SL.045.06.XXX
-	Metalik Bronz	Metallic Bronze	SL.045.07.XXX
1015	Krem	Ivory	SL.045.08.XXX
-	Koyu bej	Dark beige	SL.045.09.XXX
-	Açık bej	Light beige	SL.045.11.XXX
6005	Yosun yeşili	Moss green	SL.045.12.XXX
-	Altın meşe	Golden oak	SL.045.17.XXX
-	Findık ahşap	Nussbaum wood	SL.045.22.XXX
-	Ceviz ahşap	Walnut wood	SL.045.25.XXX
9010	Mat beyaz	Off-white	SL.045.21.XXX

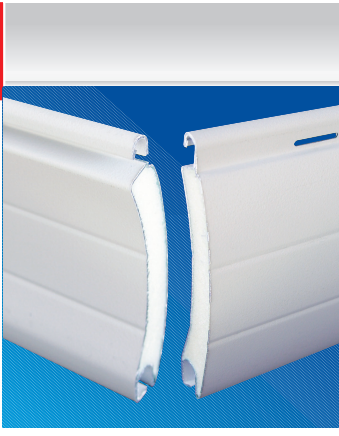

## ROLFORMİNG YÖNTEMİYLE ÜRETİLMİŞ ALÜMİNYUM PROFİLLER ROLLFORMED ALUMINIUM SLATS

ÜRÜN / ITEM	ÜRÜN ÖZELLİKLERİ		PRODUCT DESCRIPTION
	<b>SL-55 PROFİL</b> Poliüretan dolgulu, havalandırma delikli (AHO) veya deliksiz (AWH)		<b>SL-55 SLAT</b> With polyurethane foam insulation, perforated (AHO) or non perforated (AWH)
	Nominal kalınlık Kapama yüzeyi Ağırlık (m <sup>2</sup> ) max. kullanım ölçüleri 1 m yükseklikteki profil adedi  Standart üretim uzunluğu	12.3 mm 55 mm ~ 3,58 kg 3,4 x 2,5 m  18,18 (slats)  6,5 m	
<b>AMBALAJ</b>	standart palet boyu 6.500 mm. 30 adetlik paketler halinde		
<b>PACKAGING</b>	bundles of 30 bars, standard length 6.500 mm		

### STANDART RENKLER STANDARD COLORS



### ÖZEL RENKLER SPECIAL COLORS



RAL NO	RENK	COLOR	ÜRÜN KODU / CODE
9016	Beyaz	White	SL.055.01.XXX
7038	Gri	Grey	SL.055.02.XXX
8014	Kahve	Brown	SL.055.03.XXX
9006	Metalik gri	Silver metallic	SL.055.04.XXX
-	Koyu ahşap	Dark wood	SL.055.06.XXX
-	Metalik Bronz	Metallic Bronze	SL.055.07.XXX
1015	Krem	Ivory	SL.055.08.XXX
-	Koyu bej	Dark beige	SL.055.09.XXX
-	Maun ahşap	Mahogany wood	SL.055.10.XXX
-	Açık bej	Light beige	SL.055.11.XXX
6005	Yosun yeşili	Moss green	SL.055.12.XXX
-	Altın meşe	Golden oak	SL.055.17.XXX
-	Fındık ahşap	Nussbaum wood	SL.055.22.XXX
-	Ceviz ahşap	Walnut wood	SL.055.25.XXX
-	Açık ahşap	Light wood	SL.055.05.XXX
9010	Mat beyaz	Off-white	SL.055.21.XXX



## ROLFORMİNG YÖNTEMİYLE ÜRETİLMİŞ ALÜMİNYUM PROFİLLER ROLLFORMED ALUMINIUM SLATS

ÜRÜN / ITEM	ÜRÜN ÖZELLİKLERİ	PRODUCT DESCRIPTION
	<b>SL-56 PROFİL</b> Poliüretan dolgulu, havalandırma deliksiz (AWH)  Nominal kalınlık 11,5 mm Kapama yüzeyi 55 mm Ağırlık (m <sup>2</sup> ) ~ 2,75 kg max. kullanım ölçüleri 3,0 x 2,2 m 1 m yükseklikteki profil adedi ~18,18 (slats)  Standart üretim uzunluğu 6,5 m	<b>SL-56 SLAT</b> With polyurethane foam insulation, non perforated (AWH)  Nominal thickness 11,5 mm Surface area 55 mm Weight per sqm. ~ 2,75 kg max. usage sizes 3,0 x 2,2 m No. of slats per 1 m height ~18,18 (slats)  Standard manufacturing length 6,5 m
	<b>AMBALAJ</b> standart palet boyu 6.500 mm. 30 adetlik paketler halinde <b>PACKAGING</b> bundles of 30 bars, standard length 6.500 mm	

### STANDART RENKLER STANDARD COLORS

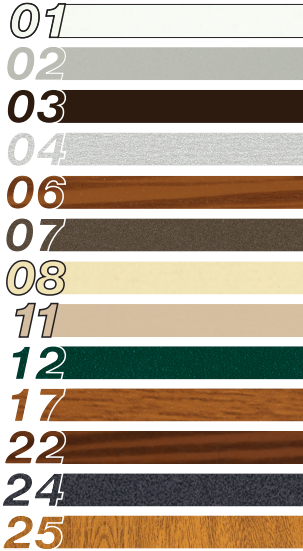

### ÖZEL RENKLER SPECIAL COLORS



RAL NO	RENK	COLOR	ÜRÜN KODU / CODE
9016	Beyaz	White	SL.056.01.XXX
7038	Gri	Grey	SL.056.02.XXX
8014	Kahve	Brown	SL.056.03.XXX
9006	Metalik gri	Silver metallic	SL.056.04.XXX
-	Koyu ahşap	Dark wood	SL.056.06.XXX
-	Bronz	Bronze	SL.056.07.XXX
1015	Krem	Ivory	SL.056.08.XXX
-	Açık bej	Light beige	SL.056.11.XXX
6005	Yosun yeşili	Moss green	SL.056.12.XXX
-	Altın meşe	Golden oak	SL.056.17.XXX
-	Findik ahşap	Nussbaum wood	SL.056.22.XXX
7016	Koyu Gri (antrasit)	Dark Gray (anthracite)	SL.056.24.XXX
-	Ceviz ahşap	Walnut wood	SL.056.25.XXX
-	Metalik koyu gri	Metallic dark grey	SL.056.46.XXX
-	Metalik açık bronz	Metallic light bronze	SL.056.47.XXX
1013	Açık krem	Light ivory	SL.056.48.XXX
-	Açık kahve	Light brown	SL.056.49.XXX



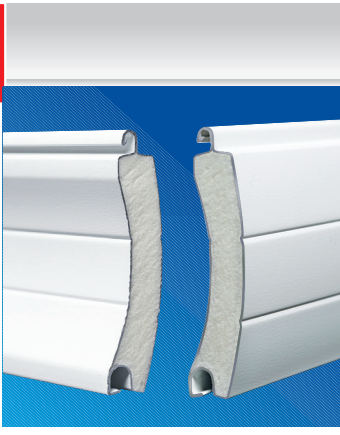

## ROLFORMİNG YÖNTEMİYLE ÜRETİLMİŞ ALÜMİNYUM PROFİLLER *ROLLFORMED ALUMINIUM SLATS*

ÜRÜN / ITEM	ÜRÜN ÖZELLİKLERİ		PRODUCT DESCRIPTION
	<b>SL-77 PROFİL</b> Poliüretan dolgulu, havalandırma deliksiz (AWH)		<b>SL-77 SLAT</b> <i>With polyurethane foam            insulation, non perforated (AWH)</i>
	Nominal kalınlık Kapama yüzeyi Ağırlık (m <sup>2</sup> ) max. kullanım ölçüleri 1 m yükseklikteki profil adedi  Standart üretim uzunluğu	18,5 mm 77 mm ~ 4,65 kg 5 x 3 m  12,99 (slats)  6,5 m	
<b>AMBALAJ</b>	standart palet boyları 4.000 mm, 4.600 mm, 5.200 mm, 6.000 mm, 6.500 mm, 7.000 mm, 7.500 mm 10 adetlik paketler halinde		
<b>PACKAGING</b>	<i>bundles of 10 bars, standard lengths 4.000 mm, 4.600 mm, 5.200 mm, 6.000 mm, 6.500 mm, 7.000 mm, 7.500 mm</i>		

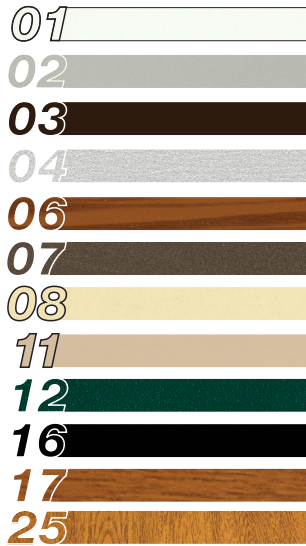

RAL NO	RENK	COLOR	ÜRÜN KODU / CODE
9016	Beyaz	White	SL.077.01.AWH
7038	Gri	Grey	SL.077.02.AWH
8014	Kahve	Brown	SL.077.03.AWH
9006	Metalik gri	Silver metallic	SL.077.04.AWH
-	Koyu ahşap	Dark wood	SL.077.06.AWH
-	Bronz	Bronze	SL.077.07.AWH
1015	Krem	Ivory	SL.077.08.AWH
-	Açık bej	Light beige	SL.077.11.AWH
6005	Yosun yeşili	Moss green	SL.077.12.AWH
8022	Siyah	Black	SL.077.16.AWH
-	Altın meşe	Golden oak	SL.077.17.AWH
-	Ceviz ahşap	Walnut wood	SL.077.25.AWH

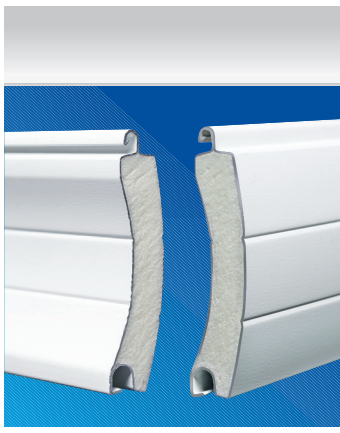

## ROLFORMİNG YÖNTEMİYLE ÜRETİLMİŞ ALÜMİNYUM PROFİLLER *ROLLFORMED ALUMINIUM SLATS*

ÜRÜN / ITEM	ÜRÜN ÖZELLİKLERİ		PRODUCT DESCRIPTION
	<b>SL-S77 PROFİL</b> Poliüretan dolgulu, havalandırma deliksiz (AWH)		<b>SL-S77 SLAT</b> <i>With polyurethane foam            insulation, non perforated (AWH)</i>
	Nominal kalınlık Kapama yüzeyi Ağırlık (m <sup>2</sup> ) max. kullanım ölçüleri 1 m yükseklikteki profil adedi  Standart üretim uzunluğu	18,5 mm 77 mm ~3,70 kg 4,5 x 3 m  12,99 (slats)  6,5 m	
<b>AMBALAJ</b>	standart palet boyları 4.000 mm, 4.600 mm, 5.200 mm, 6.000 mm, 6.500 mm, 7.000 mm, 7.500 mm 10 adetlik paketler halinde		
<b>PACKAGING</b>	<i>bundles of 10 bars, standard lengths 4.000 mm, 4.600 mm, 5.200 mm, 6.000 mm, 6.500 mm, 7.000 mm, 7.500 mm</i>		

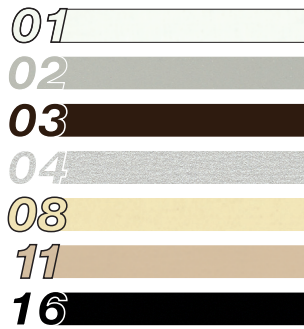

RAL NO	RENK	COLOR	ÜRÜN KODU / CODE
9016	Beyaz	White	SL.S77.01.AWH
7038	Gri	Grey	SL.S77.02.AWH
8014	Kahve	Brown	SL.S77.03.AWH
9006	Metalik gri	Silver metallic	SL.S77.04.AWH
1015	Krem	Ivory	SL.S77.08.AWH
-	Açık bej	Light beige	SL.S77.11.AWH
8022	Siyah	Black	SL.S77.16.AWH

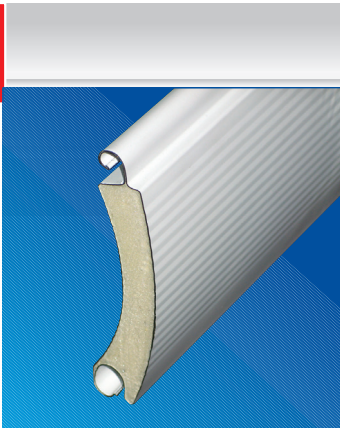

## ROLFORMİNG YÖNTEMİYLE ÜRETİLMİŞ ALÜMİNYUM PROFİLLER *ROLLFORMED ALUMINIUM SLATS*

ÜRÜN / ITEM	ÜRÜN ÖZELLİKLERİ		PRODUCT DESCRIPTION
	<b>SL-100 PROFİL</b> Poliüretan dolgulu, havalandırma deliksiz (AWH)		<b>SL-100 SLAT</b> With polyurethane foam insulation, non perforated (AWH)
	Nominal kalınlık Kapama yüzeyi Ağırlık (m <sup>2</sup> ) max. kullanım ölçüleri 1 m yükseklikteki profil adedi Standart üretim uzunluğu	24 mm 96 mm ~ 4,85 kg 6,5 x 4 m 10,41 (slats) 6,5 m	
<b>AMBALAJ</b>	standart palet boyları 6.000 mm, 6.500 mm, 7.000 mm, 7.500 mm, 8.000 mm 8 adetlik paketler halinde		
<b>PACKAGING</b>	<i>bundles of 8 bars, standard lengths 6.000 mm, 6.500 mm, 7.000 mm, 7.500 mm, 8.000 mm</i>		

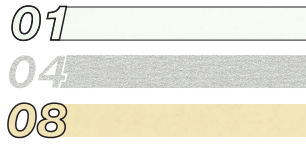

RAL NO	RENK	COLOR	ÜRÜN KODU / CODE
9016	Beyaz	White	SL.100.01.AWH
9006	Metalik gri	Silver metallic	SL.100.04.AWH
1015	Krem	Ivory	SL.100.08.AWH

Diğer renkler ve üretim boyları için bilgi alınız.  
*Please contact us for other colors and production lengths.*

1

2

3

4

5

6

7

8

9

10

11

12

13

14

15

16

17

18

19

20

21

22

23

24

25

26

27

28

29

**Rolforming Yöntemiyle Üretilmiş  
PVC Kaplı ve Boyalı Galvanizli Çelik Profiller**

*Rollformed PVC Coated and Prepainted  
Galvanized Steel Slats*

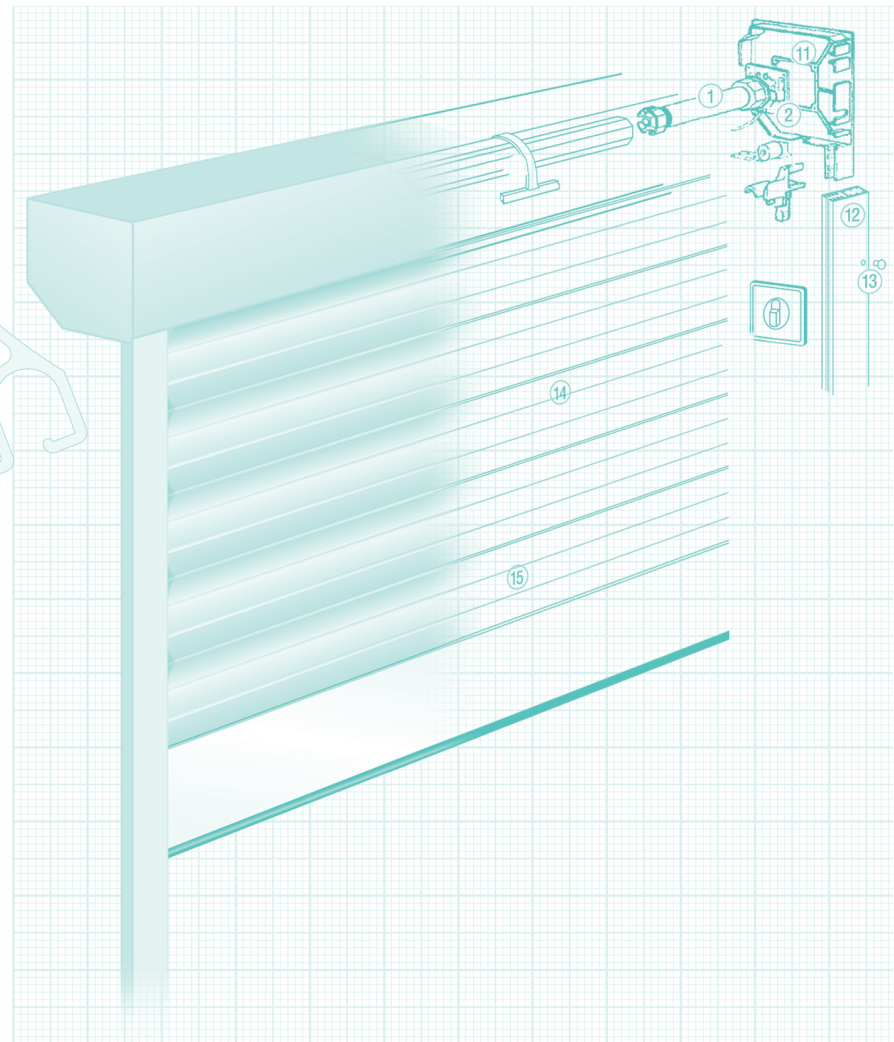
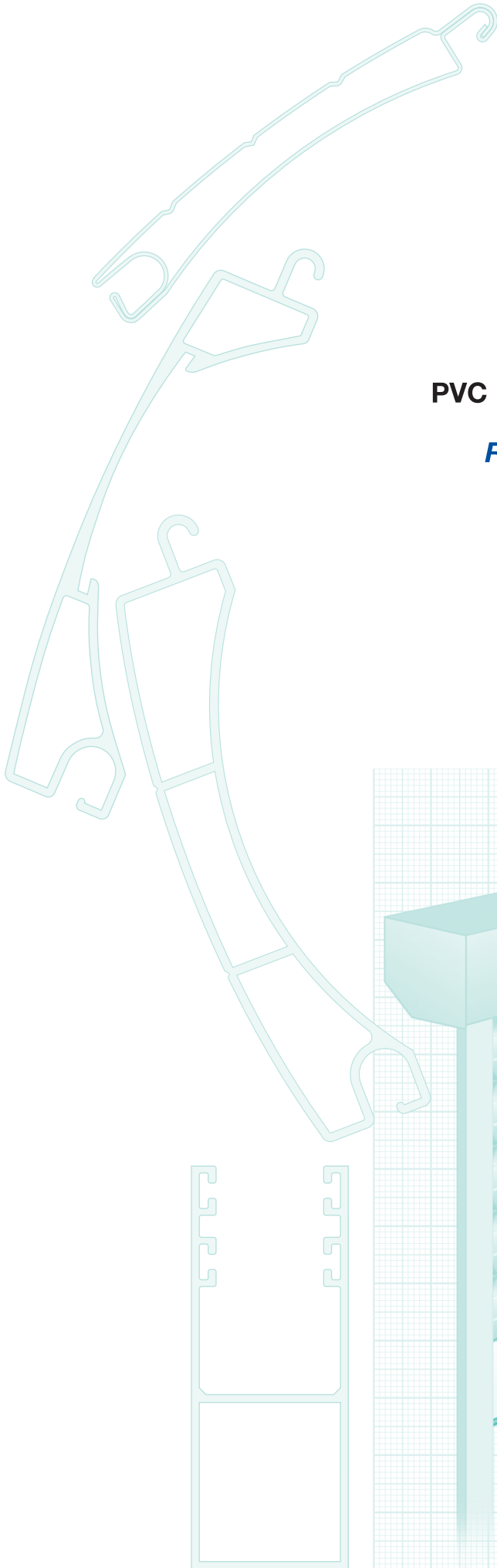



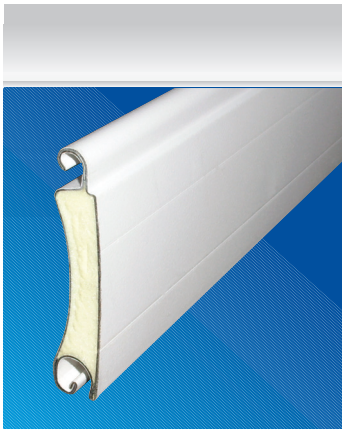

**POLFORMİNG YÖNTEMİYLE ÜRETİLMİŞ  
PVC KAPLI VE YÜZEYİ BOYALI GALVANİZLİ ÇELİK PROFİLLER**  
**ROLLFORMED PVC COATED AND PREPAINTED  
GALVANIZED STEEL SLATS**

ÜRÜN / ITEM	ÜRÜN ÖZELLİKLERİ		PRODUCT DESCRIPTION	
	<b>ST-55 PROFİL</b> Poliüretan dolgulu, havalandırma deliksiz (AWH) PVC kaplı galvanizli çelik profil		<b>ST-55 SLAT</b> With polyurethane foam insulation, non perforated (AWH) PVC coated galvanized steel slat	
	Nominal kalınlık Kapama yüzeyi Ağırlık (m <sup>2</sup> ) max. kullanım ölçüleri 1 m yükseklikteki profil adedi	13 mm 55 mm ~ 14,00 kg 4,25 x 3 m 18,18 (slats)		Nominal thickness Surface area Weight per sqm. max. usage sizes No. of slats per 1 m height
	<b>AMBALAJ</b>	standart palet boyları 4.000 mm, 4.600 mm, 5.200 mm 6.000 mm, 6.500 mm, 7.000 mm 10 adetlik paketler halinde		
<b>PACKAGING</b>	bundles of 10 bars, standard lengths 4.000 mm, 4.600 mm, 5.200 mm, 6.000 mm 6.500 mm, 7.000 mm			

**YÜZEYİ BOYALI GALVANİZLİ ÇELİK PROFİLLER**  
**PREPAINTED GALVANIZED STEEL SLATS**

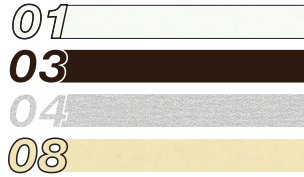

RAL NO	RENK	COLOR	ÜRÜN KODU / CODE
9016	Beyaz (özel)	White (special)	ST.055.01.AWH
8014	Kahve	Brown	ST.055.03.AWH
9006	Metalik gri	Silver metallic	ST.055.04.AWH
1015	Krem	Ivory	ST.055.08.AWH

Minimum 10.000 metre sipariş olduğunda istenilen her renkte üretim yapılır.  
Special colors can produced for min 10.000 mt.

**PVC KAPLI GALVANİZLİ ÇELİK PROFİLLER**  
**ROLLFORMED PVC COATED GALVANIZED STEEL SLATS**



RAL NO	RENK	COLOR	ÜRÜN KODU / CODE
9016	Beyaz (özel)	White (special)	ST.055.01.LAM
7038	Gri (özel)	Grey (special)	ST.055.02.LAM
9006	Metalik gri	Silver metallic	ST.055.04.LAM
1015	Krem	Ivory	ST.055.08.LAM
	Pres (galvaniz)	Mill finish (galvanised)	ST.055.00.LAM

2



**POLFORMİNG YÖNTEMİYLE ÜRETİLMİŞ  
PVC KAPLI VE YÜZEYİ BOYALI GALVANİZLİ ÇELİK PROFİLLER  
ROLLFORMED PVC COATED AND PREPAINTED  
GALVANIZED STEEL SLATS**

ÜRÜN / ITEM	ÜRÜN ÖZELLİKLERİ	PRODUCT DESCRIPTION	
	<b>ST-77 PROFİL</b> Poliüretan dolgulu, havalandırma deliksiz (AWH) PVC kaplı galvanizli çelik profil	<b>ST-77 SLAT</b> With polyurethane foam insulation, non perforated (AWH) PVC coated galvanized steel slat	
	Nominal kalınlık Kapama yüzeyi Ağırlık (m <sup>2</sup> ) max. kullanım ölçüleri 1 m yükseklikteki profil adedi	18,50 mm 77 mm ~9,85 kg 5 x 3 m 12,99 (slats)	Nominal thickness Surface area Weight per sqm. max. usage sizes No. of slats per 1 m height
	<b>AMBALAJ</b>	standart palet boyları 4.000 mm, 4.600 mm, 5.200 mm 6.000 mm, 6.500 mm, 7.000 mm 10 adetlik paketler halinde	<b>PACKAGING</b>
		bundles of 10 bars, standard lengths 4.000 mm, 4.600 mm, 5.200 mm, 6.000 mm 6.500 mm, 7.000 mm	

**YÜZEYİ BOYALI GALVANİZLİ ÇELİK PROFİLLER  
PREPAINTED GALVANIZED STEEL SLATS**

RAL NO	RENK	COLOR	ÜRÜN KODU / CODE
9016	Beyaz (özel)	White (special)	ST.077.01.AWH
8014	Kahve	Brown	ST.077.03.AWH
9006	Metalik gri	Silver metallic	ST.077.04.AWH
1015	Krem	Ivory	ST.077.08.AWH

Minimum 10.000 metre sipariş olduğunda istenilen her renkte üretim yapılır.  
Special colors can produced for min 10.000 mt.

**PVC KAPLI GALVANİZLİ ÇELİK PROFİLLER  
ROLLFORMED PVC COATED GALVANIZED STEEL SLATS**

RAL NO	RENK	COLOR	ÜRÜN KODU / CODE
9016	Beyaz (özel)	White (special)	ST.077.01.LAM
7038	Gri (özel)	Grey (special)	ST.077.02.LAM
9006	Metalik gri	Silver metallic	ST.077.04.LAM
1015	Krem	Ivory	ST.077.08.LAM
	Pres (galvaniz)	Mill finish (galvanised)	ST.077.00.LAM

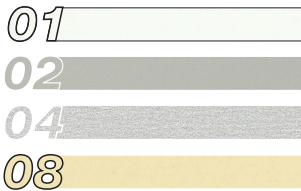
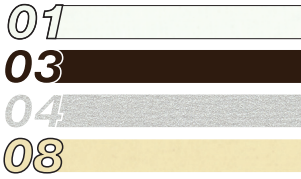

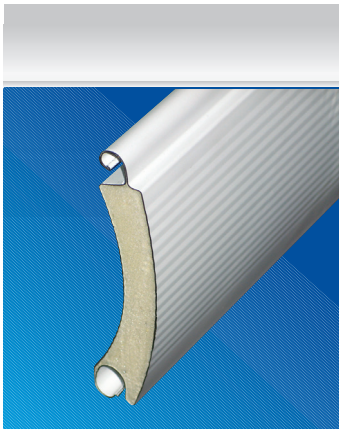

## POLFORMİNG YÖNTEMİYLE ÜRETİLMİŞ YÜZEYİ BOYALI GALVANİZLİ ÇELİK PROFİLLER *ROLLFORMED PREPAINTED GALVANIZED STEEL SLATS*

ÜRÜN / ITEM	ÜRÜN ÖZELLİKLERİ	PRODUCT DESCRIPTION
	<p><b>ST-100 PROFİL</b> Poliüretan dolgulu, havalandırma deliksiz (AWH) PVC kaplı galvanizli çelik profil</p> <p>Nominal kalınlık 24 mm Kapama yüzeyi 95 mm Ağırlık (m<sup>2</sup>) ~ 11,60 kg max. kullanım ölçüleri 7,5 x 5 m 1 m yükseklikteki profil adedi 10,41 (slats)</p> <p>Standart üretim uzunluğu 6,5 mt</p>	<p><b>ST-100 SLAT</b> <i>With polyurethane foam insulation, non perforated (AWH) PVC coated galvanized steel slat</i></p> <p><i>Nominal thickness Surface area Weight per sqm. max. usage sizes No. of slats per 1 m height Standart manufacturing length</i></p>
	<p><b>AMBALAJ</b> Standart palet boyları 6.000 mm, 6.500 mm, 7.000 mm, 7.500 mm, 8.000 mm 8 adetlik paketler halinde</p> <p><b>PACKAGING</b> <i>Bundles of 8 bars standart lengths 6.000 mm, 6.500 mm, 7.000 mm, 7.500 mm, 8.000 mm</i></p>	

## YÜZEYİ BOYALI GALVANİZLİ ÇELİK PROFİLLER *PREPAINTED GALVANIZED STEEL SLATS*

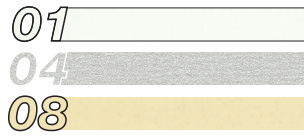

RAL NO	RENK	COLOR	ÜRÜN KODU / CODE
9016	Beyaz	<i>White</i>	ST.100.01.AWH
9006	Metalik gri	<i>Silver metallic</i>	ST.100.04.AWH
1015	Krem	<i>Ivory</i>	ST.100.08.AWH

Minimum 10.000 metre sipariş olduğunda istenilen her renkte üretim yapılır.  
*Special colors can produced for min 10.000 mt.*  
Diğer renkler ve üretim boyları için bilgi alınız.  
*Please contact us for other colors and production lengths.*

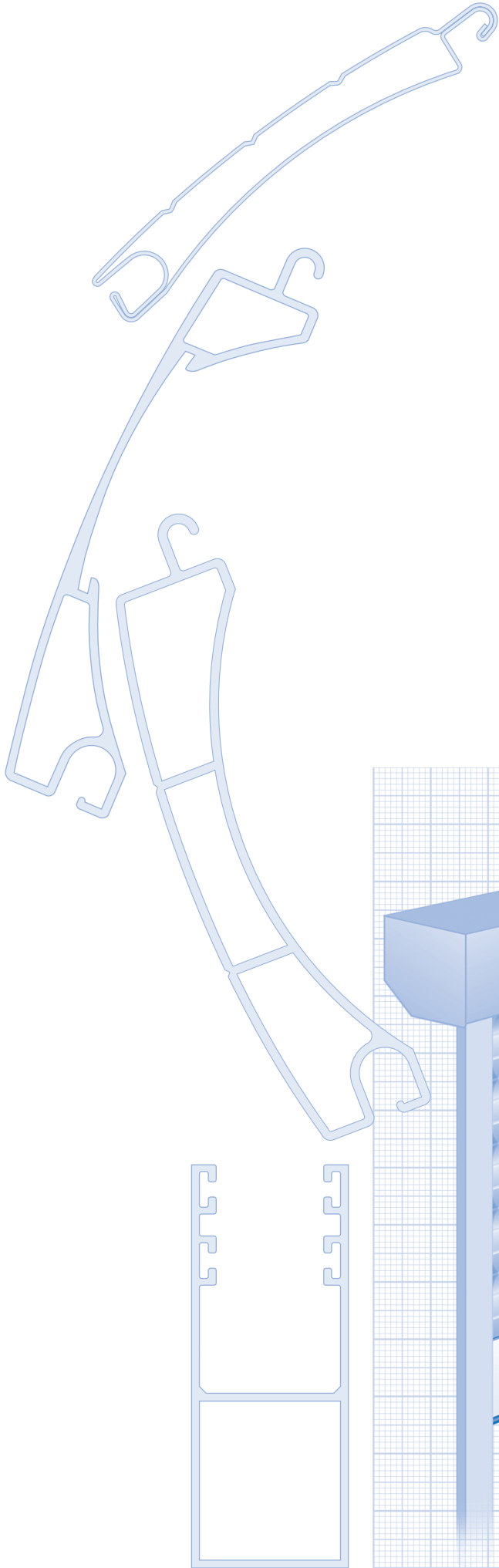

## Ekstrüzyon Yöntemiyle Üretilmiş Alüminyum Profiller

*Extruded Aluminium Profiles*

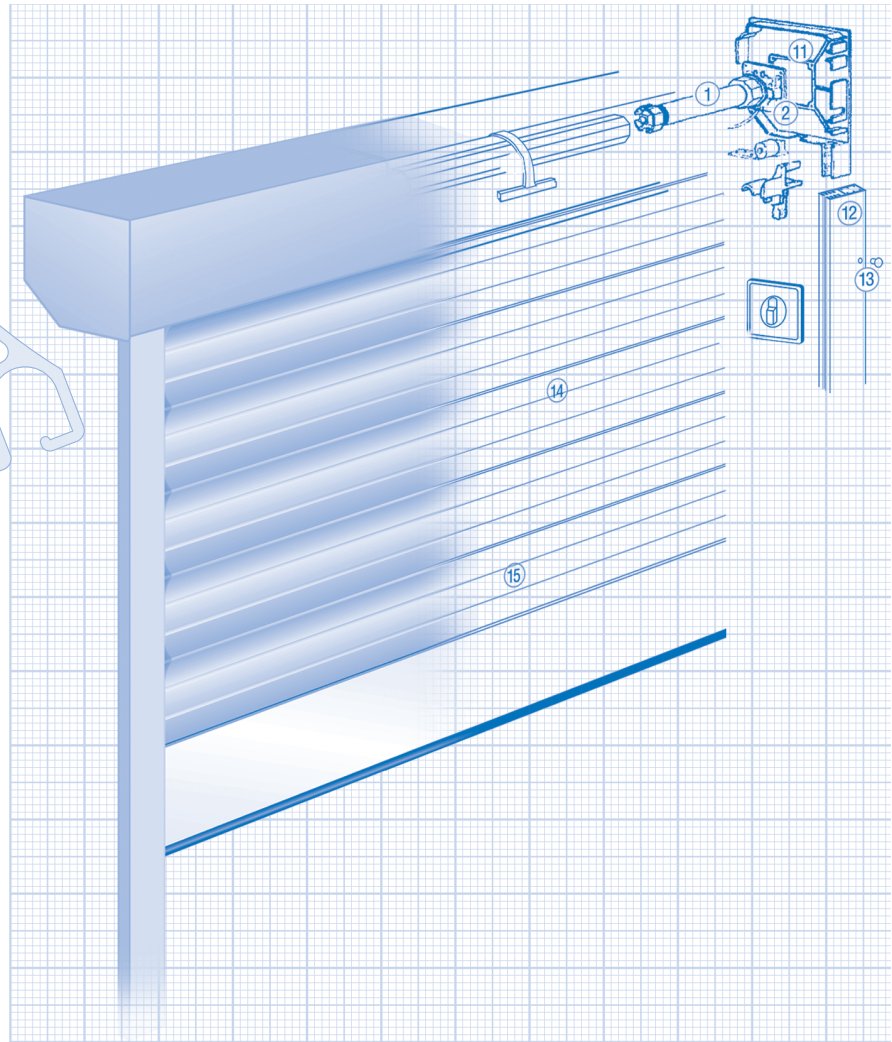

- 1
- 2
- 3
- 4
- 5
- 6
- 7
- 8
- 9
- 10
- 11
- 12
- 13
- 14
- 15
- 16
- 17
- 18
- 19
- 20
- 21
- 22
- 23
- 24
- 25
- 26
- 27
- 28
- 29





## EKSTRÜZYON YÖNTEMİYLE ÜRETİLMİŞ ALÜMİNYUM PROFİLLER *EXTRUDED ALUMINIUM PROFILES*

ÜRÜN / ITEM	ÜRÜN ÖZELLİKLERİ		PRODUCT DESCRIPTION																																
	<b>SE-45 PROFİL</b> Alüminyum ekstrüzyon profil  Nominal kalınlık 10 mm Kapama yüzeyi 45 mm Ağırlık (m <sup>2</sup> ) 7,10 kg max. kullanım ölçüleri 4,5 x 3 m 1 m yükseklikteki profil adedi 22,22		<b>SE-45 PROFILE</b> <i>Extruded aluminium profile</i>  <i>Nominal thickness</i> <i>Surface area</i> <i>Weight per sqm.</i> <i>max. usage sizes</i> <i>No. of slats per 1 m height</i>																																
	<b>AMBALAJ</b> siparişe göre özel üretilir <b>PACKAGING</b> <i>customize upon order</i>																																		
	<table border="1"> <thead> <tr> <th>RAL NO</th> <th>RENK</th> <th>COLOR</th> <th>ÜRÜN KODU / CODE</th> </tr> </thead> <tbody> <tr> <td>-</td> <td>Pres</td> <td><i>Mill finish</i></td> <td>SE.045.00.EXT</td> </tr> <tr> <td>9016</td> <td>Beyaz</td> <td><i>White</i></td> <td>SE.045.01.EXT</td> </tr> <tr> <td>7038</td> <td>Gri</td> <td><i>Grey</i></td> <td>SE.045.02.EXT</td> </tr> <tr> <td>8014</td> <td>Kahve</td> <td><i>Brown</i></td> <td>SE.045.03.EXT</td> </tr> <tr> <td>9006</td> <td>Metalik gri</td> <td><i>Silver metallic</i></td> <td>SE.045.04.EXT</td> </tr> <tr> <td>1015</td> <td>Krem</td> <td><i>Ivory</i></td> <td>SE.045.08.EXT</td> </tr> <tr> <td></td> <td>Diğer RAL</td> <td><i>Other RAL colors</i></td> <td>SE.045.RA.EXT</td> </tr> </tbody> </table>	RAL NO	RENK	COLOR	ÜRÜN KODU / CODE	-	Pres	<i>Mill finish</i>	SE.045.00.EXT	9016	Beyaz	<i>White</i>	SE.045.01.EXT	7038	Gri	<i>Grey</i>	SE.045.02.EXT	8014	Kahve	<i>Brown</i>	SE.045.03.EXT	9006	Metalik gri	<i>Silver metallic</i>	SE.045.04.EXT	1015	Krem	<i>Ivory</i>	SE.045.08.EXT		Diğer RAL	<i>Other RAL colors</i>	SE.045.RA.EXT		
RAL NO	RENK	COLOR	ÜRÜN KODU / CODE																																
-	Pres	<i>Mill finish</i>	SE.045.00.EXT																																
9016	Beyaz	<i>White</i>	SE.045.01.EXT																																
7038	Gri	<i>Grey</i>	SE.045.02.EXT																																
8014	Kahve	<i>Brown</i>	SE.045.03.EXT																																
9006	Metalik gri	<i>Silver metallic</i>	SE.045.04.EXT																																
1015	Krem	<i>Ivory</i>	SE.045.08.EXT																																
	Diğer RAL	<i>Other RAL colors</i>	SE.045.RA.EXT																																

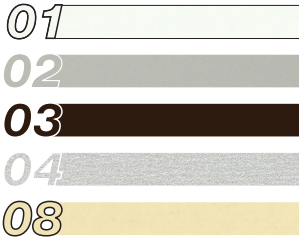



## EKSTRÜZYON YÖNTEMİYLE ÜRETİLMİŞ ALÜMİNYUM PROFİLLER EXTRUDED ALUMINIUM PROFILES

ÜRÜN / ITEM	ÜRÜN ÖZELLİKLERİ		PRODUCT DESCRIPTION	
	<b>SE-60 PROFİL</b> Alüminyum ekstrüzyon profil		<b>SE-60 PROFILE</b> Extruded aluminium profile	
	Nominal kalınlık Kapama yüzeyi Ağırlık (m <sup>2</sup> ) max. kullanım ölçüleri 1 m yükseklikteki profil adedi  Standart üretim uzunluğu	13,16 mm 56 mm ~ 8,00 kg 5 x 3 m  17,86 (slats)  6,5 m		Nominal thickness Surface area Weight per sqm. max. usage sizes No. of slats per 1 m height  Standard manufacturing length
	<b>AMBALAJ</b>	siparişe göre özel üretilir		
	<b>PACKAGING</b>	customize upon order		
	<b>RAL NO</b>	<b>RENK</b>	<b>COLOR</b>	<b>ÜRÜN KODU / CODE</b>
	-	Pres	Mill finish	SE.060.00.EXT
01	9016	Beyaz	White	SE.060.01.EXT
02	7038	Gri	Grey	SE.060.02.EXT
03	8014	Kahve	Brown	SE.060.03.EXT
04	9006	Metalik gri	Silver metallic	SE.060.04.EXT
08	1015	Krem	Ivory	SE.060.08.EXT
		Diğer RAL	Other RAL colors	SE.060.RA.EXT

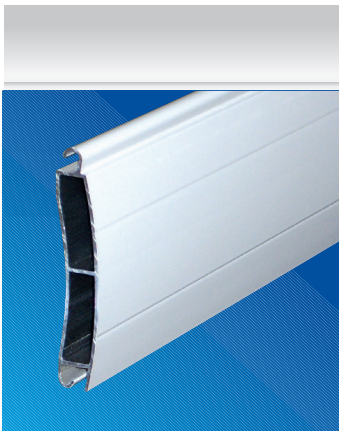

## EKSTRÜZYON YÖNTEMİYLE ÜRETİLMİŞ ALÜMİNYUM PROFİLLER EXTRUDED ALUMINIUM PROFILES

ÜRÜN / ITEM	ÜRÜN ÖZELLİKLERİ	PRODUCT DESCRIPTION
	<b>SE-62 PROFİL</b> Alüminyum ekstrüzyon profil  Nominal kalınlık 13,13 mm Kapama yüzeyi 62,5 mm Ağırlık (m <sup>2</sup> ) ~ 8,00 kg max. kullanım ölçüleri 5 x 3 m 1 m yükseklikteki profil adedi 16 (slats)	<b>SE-62 PROFILE</b> Extruded aluminium profile  Nominal thickness 13,13 mm Surface area 62,5 mm Weight per sqm. ~ 8,00 kg max. usage sizes 5 x 3 m No. of slats per 1 m height 16 (slats)
	<b>AMBALAJ</b> standart profil boyları 4.000, 4.500, 5.200, 6.000, 6.500 mm, 10 adetlik paketler halinde	
	<b>PACKAGING</b> bundles of 10 bars, standard lengths 4.000, 4.500, 5.200, 6.000, 6.500 mm	

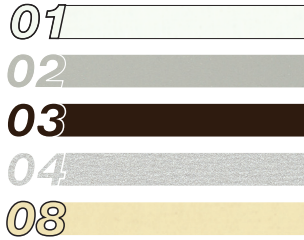

RAL NO	RENK	COLOR	ÜRÜN KODU / CODE
-	Pres	Mill finish	SE.062.00.EXT
9016	Beyaz	White	SE.062.01.EXT
7038	Gri	Grey	SE.062.02.EXT
8014	Kahve	Brown	SE.062.03.EXT
9006	Metalik gri	Silver metallic	SE.062.04.EXT
1015	Krem	Ivory	SE.062.08.EXT
	Diğer RAL	Other RAL colors	SE.062.RA.EXT



## EKSTRÜZYON YÖNTEMİYLE ÜRETİLMİŞ ALÜMİNYUM PROFİLLER *EXTRUDED ALUMINIUM PROFILES*

ÜRÜN / ITEM	ÜRÜN ÖZELLİKLERİ	PRODUCT DESCRIPTION																																
	<b>SE-E62 PROFİL</b> Alüminyum ekstrüzyon profil  Nominal kalınlık 16,20 mm Kapama yüzeyi 62,5 mm Ağırlık (m <sup>2</sup> ) ~ 7,500 kg max. kullanım ölçüleri 5 x 3 m 1 m yükseklikteki profil adedi 16 (slats)	<b>SE-E62 PROFILE</b> <i>Extruded aluminium profile</i>  <i>Nominal thickness 16,20 mm</i> <i>Surface area 62,5 mm</i> <i>Weight per sqm. ~ 7,500 kg</i> <i>max. usage sizes 5 x 3 m</i> <i>No. of slats per 1 m height 16 (slats)</i>																																
	<b>AMBALAJ</b> standart profil boyları 3.500, 3.800, 4.000, 4.500, 5.200, 6.000, 6.500 mm, 10 adetlik paketler halinde	<b>PACKAGING</b> <i>bundles of 10 bars, standard lengths 3.500, 3.800, 4.000, 4.500, 5.200, 6.000, 6.500 mm</i>																																
	<table border="1"> <thead> <tr> <th>RAL NO</th> <th>RENK</th> <th>COLOR</th> <th>ÜRÜN KODU / CODE</th> </tr> </thead> <tbody> <tr> <td>-</td> <td>Pres</td> <td><i>Mill finish</i></td> <td>SE.E62.00.EXT</td> </tr> <tr> <td>9016</td> <td>Beyaz</td> <td><i>White</i></td> <td>SE.E62.01.EXT</td> </tr> <tr> <td>7038</td> <td>Gri</td> <td><i>Grey</i></td> <td>SE.E62.02.EXT</td> </tr> <tr> <td>8014</td> <td>Kahve</td> <td><i>Brown</i></td> <td>SE.E62.03.EXT</td> </tr> <tr> <td>9006</td> <td>Metalik gri</td> <td><i>Silver metallic</i></td> <td>SE.E62.04.EXT</td> </tr> <tr> <td>1015</td> <td>Krem</td> <td><i>Ivory</i></td> <td>SE.E62.08.EXT</td> </tr> <tr> <td></td> <td>Diğer RAL</td> <td><i>Other RAL colors</i></td> <td>SE.E62.RA.EXT</td> </tr> </tbody> </table>	RAL NO	RENK	COLOR	ÜRÜN KODU / CODE	-	Pres	<i>Mill finish</i>	SE.E62.00.EXT	9016	Beyaz	<i>White</i>	SE.E62.01.EXT	7038	Gri	<i>Grey</i>	SE.E62.02.EXT	8014	Kahve	<i>Brown</i>	SE.E62.03.EXT	9006	Metalik gri	<i>Silver metallic</i>	SE.E62.04.EXT	1015	Krem	<i>Ivory</i>	SE.E62.08.EXT		Diğer RAL	<i>Other RAL colors</i>	SE.E62.RA.EXT	
RAL NO	RENK	COLOR	ÜRÜN KODU / CODE																															
-	Pres	<i>Mill finish</i>	SE.E62.00.EXT																															
9016	Beyaz	<i>White</i>	SE.E62.01.EXT																															
7038	Gri	<i>Grey</i>	SE.E62.02.EXT																															
8014	Kahve	<i>Brown</i>	SE.E62.03.EXT																															
9006	Metalik gri	<i>Silver metallic</i>	SE.E62.04.EXT																															
1015	Krem	<i>Ivory</i>	SE.E62.08.EXT																															
	Diğer RAL	<i>Other RAL colors</i>	SE.E62.RA.EXT																															

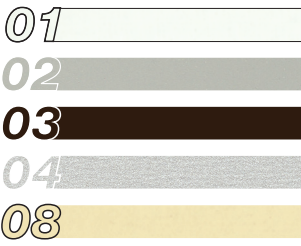





## EKSTRÜZYON YÖNTEMİYLE ÜRETİLMİŞ ALÜMİNYUM PROFİLLER *EXTRUDED ALUMINIUM PROFILES*

ÜRÜN / ITEM	ÜRÜN ÖZELLİKLERİ		PRODUCT DESCRIPTION
	<b>SE-77 PROFİL</b> Alüminyum ekstrüzyon profil  Nominal kalınlık 14,30 mm Kapama yüzeyi 77 mm Ağırlık (m <sup>2</sup> ) ~ 6,800 kg max. kullanım ölçüleri 6 x 3,5 m 1 m yükseklikteki profil adedi 12,99 (slats)		<b>SE-77 PROFILE</b> <i>Extruded aluminium profile</i>  <i>Nominal thickness</i> <i>Surface area</i> <i>Weight per sqm.</i> <i>max. usage sizes</i> <i>No. of slats per 1 m height</i>
	<b>AMBALAJ</b>	standart profil boyları 3.800, 4.000, 4.500, 5.200, 6.000, 6.500, 7.000 mm, 5 adetlik paketler halinde	
	<b>PACKAGING</b>	<i>bundles of 5 bars, standard lengths 3.800, 4.000, 4.500, 5.200, 6.000, 6.500, 7.000 mm</i>	

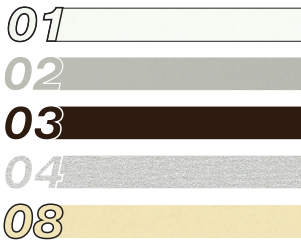

RAL NO	RENK	COLOR	ÜRÜN KODU / CODE
-	Pres	<i>Mill finish</i>	SE.077.00.EXT
9016	Beyaz	<i>White</i>	SE.077.01.EXT
7038	Gri	<i>Grey</i>	SE.077.02.EXT
8014	Kahve	<i>Brown</i>	SE.077.03.EXT
9006	Metalik gri	<i>Silver metallic</i>	SE.077.04.EXT
1015	Krem	<i>Ivory</i>	SE.077.08.EXT
	Diğer RAL	<i>Other RAL colors</i>	SE.077.RA.EXT

3



## EKSTRÜZYON YÖNTEMİYLE ÜRETİLMİŞ ALÜMİNYUM PROFİLLER EXTRUDED ALUMINIUM PROFILES

ÜRÜN / ITEM	ÜRÜN ÖZELLİKLERİ		PRODUCT DESCRIPTION
	<b>SE-E77 PROFİL</b> Alüminyum ekstrüzyon profil  Nominal kalınlık 14,30 mm Kapama yüzeyi 77 mm Ağırlık (m <sup>2</sup> ) ~ 7,800 kg max. kullanım ölçüleri 7 x 3,5 m 1 m yükseklikteki profil adedi 12,99 (slats)		<b>SE-E77 PROFILE</b> Extruded aluminium profile  Nominal thickness 14,30 mm Surface area 77 mm Weight per sqm. ~ 7,800 kg max. usage sizes 7 x 3,5 m No. of slats per 1 m height 12,99
	<b>AMBALAJ</b>	standart profil boyları 3.800, 4.000, 4.500, 5.200, 6.000, 6.500, 7.000 mm, 5 adetlik paketler halinde	
	<b>PACKAGING</b>	bundles of 5 bars, standard lengths 3.800, 4.000, 4.500, 5.200, 6.000, 6.500, 7.000 mm	

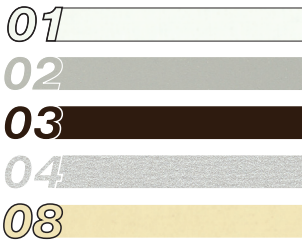

RAL NO	RENK	COLOR	ÜRÜN KODU / CODE
-	Pres	Mill finish	SE.E77.00.EXT
9016	Beyaz	White	SE.E77.01.EXT
7038	Gri	Grey	SE.E77.02.EXT
8014	Kahve	Brown	SE.E77.03.EXT
9006	Metalik gri	Silver metallic	SE.E77.04.EXT
1015	Krem	Ivory	SE.E77.08.EXT
	Diğer RAL	Other RAL colors	SE.E77.RA.EXT



## EKSTRÜZYON YÖNTEMİYLE ÜRETİLMİŞ ALÜMİNYUM PROFİLLER *EXTRUDED ALUMINIUM PROFILES*

ÜRÜN / ITEM	ÜRÜN ÖZELLİKLERİ	PRODUCT DESCRIPTION																																	
	<b>SE-100 PROFİL</b> Alüminyum ekstrüzyon profil  Nominal kalınlık 25 mm Kapama yüzeyi 100 mm Ağırlık (m <sup>2</sup> ) ~ 11,5 kg max. kullanım ölçüleri 8,5 x 4 m 1 m yükseklikteki profil adedi 10 (slats)	<b>SE-100 PROFILE</b> <i>Extruded aluminium profile</i>  <i>Nominal thickness</i> <i>Surface area</i> <i>Weight per sqm.</i> <i>max. usage sizes</i> <i>No. of slats per 1 m height</i>																																	
	<b>AMBALAJ</b> siparişe göre özel üretilir																																		
	<b>PACKAGING</b> <i>customize upon order</i>																																		
	<table border="1"> <thead> <tr> <th>RAL NO</th> <th>RENK</th> <th>COLOR</th> <th>ÜRÜN KODU / CODE</th> </tr> </thead> <tbody> <tr> <td>-</td> <td>Pres</td> <td><i>Mill finish</i></td> <td>SE.100.00.EXT</td> </tr> <tr> <td>9016</td> <td>Beyaz</td> <td><i>White</i></td> <td>SE.100.01.EXT</td> </tr> <tr> <td>7038</td> <td>Gri</td> <td><i>Grey</i></td> <td>SE.100.02.EXT</td> </tr> <tr> <td>8014</td> <td>Kahve</td> <td><i>Brown</i></td> <td>SE.100.03.EXT</td> </tr> <tr> <td>9006</td> <td>Metalik gri</td> <td><i>Silver metallic</i></td> <td>SE.100.04.EXT</td> </tr> <tr> <td>1015</td> <td>Krem</td> <td><i>Ivory</i></td> <td>SE.100.08.EXT</td> </tr> <tr> <td></td> <td>Diğer RAL</td> <td><i>Other RAL colors</i></td> <td>SE.100.RA.EXT</td> </tr> </tbody> </table>	RAL NO	RENK	COLOR	ÜRÜN KODU / CODE	-	Pres	<i>Mill finish</i>	SE.100.00.EXT	9016	Beyaz	<i>White</i>	SE.100.01.EXT	7038	Gri	<i>Grey</i>	SE.100.02.EXT	8014	Kahve	<i>Brown</i>	SE.100.03.EXT	9006	Metalik gri	<i>Silver metallic</i>	SE.100.04.EXT	1015	Krem	<i>Ivory</i>	SE.100.08.EXT		Diğer RAL	<i>Other RAL colors</i>	SE.100.RA.EXT		
RAL NO	RENK	COLOR	ÜRÜN KODU / CODE																																
-	Pres	<i>Mill finish</i>	SE.100.00.EXT																																
9016	Beyaz	<i>White</i>	SE.100.01.EXT																																
7038	Gri	<i>Grey</i>	SE.100.02.EXT																																
8014	Kahve	<i>Brown</i>	SE.100.03.EXT																																
9006	Metalik gri	<i>Silver metallic</i>	SE.100.04.EXT																																
1015	Krem	<i>Ivory</i>	SE.100.08.EXT																																
	Diğer RAL	<i>Other RAL colors</i>	SE.100.RA.EXT																																

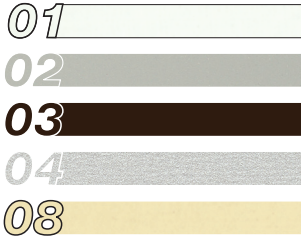



**Ekstrüzyon Yöntemiyle Üretilmiş  
Alüminyum Profiller (Pencereli)**  
*Extruded Aluminium Profiles  
(Perforated)*

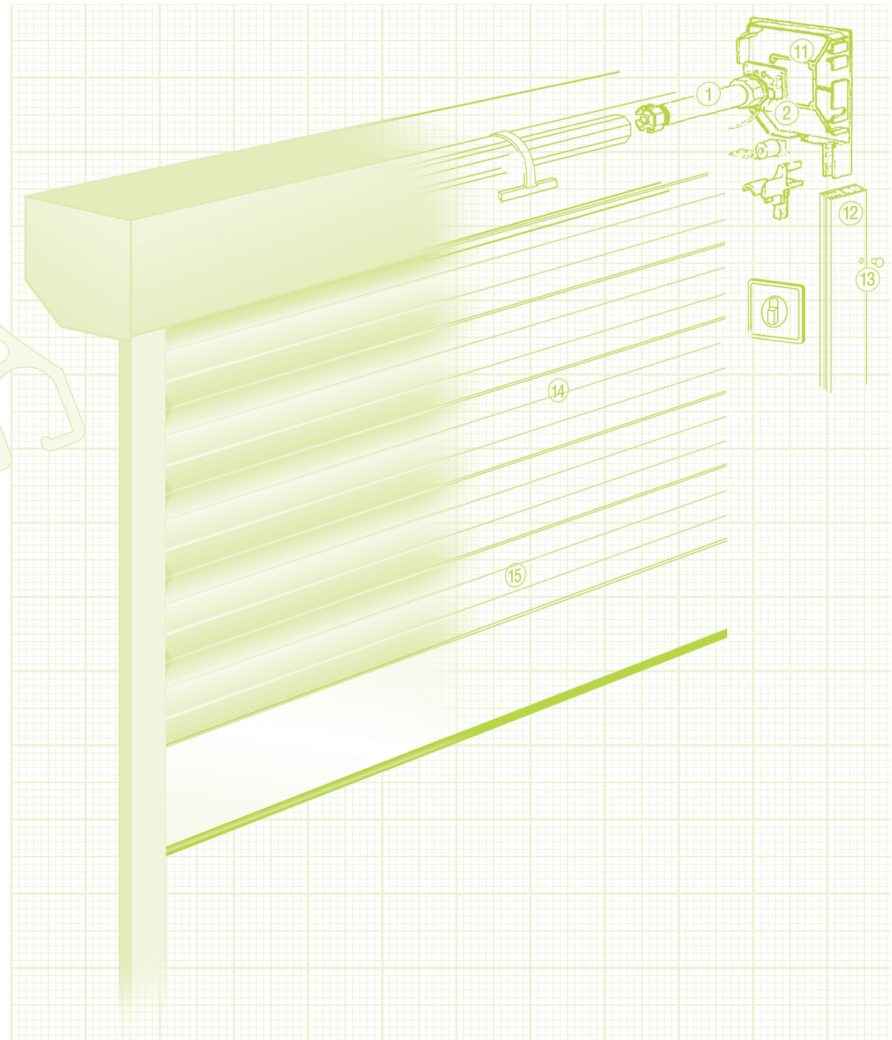



## EKSTRÜZYON YÖNTEMİYLE ÜRETİLMİŞ ALÜMİNYUM PROFİLLER EXTRUDED ALUMINIUM PROFILES

4

ÜRÜN / ITEM	ÜRÜN ÖZELLİKLERİ	PRODUCT DESCRIPTION		
	<b>SE-63 PROFİL</b> Alüminyum ekstrüzyon profil  Nominal kalınlık 13,20 mm Kapama yüzeyi 62,5 mm Ağırlık (m <sup>2</sup> ) ~ 5,5 kg max. kullanım ölçüleri 5 x 3 m 1 m yükseklikteki profil adedi 16 (slats)	<b>SE-63 PROFILE</b> Extruded aluminium profile  Nominal thickness 13,20 mm Surface area 62,5 mm Weight per sqm. ~ 5,5 kg max. usage sizes 5 x 3 m No. of slats per 1 m height 16 (slats)		
	SE-62 Alüminyum uyumlu	For Aluminium SE-62		
	<b>AMBALAJ</b>	standart profil boyları 4.000, 4.500, 5.200, 6.000, 6.500 mm, 5 adetlik paketler halinde		
	<b>PACKAGING</b>	bundles of 5 bars, standard lengths 4.000, 4.500, 5.200, 6.000, 6.500 mm		
	<b>RAL NO</b>	<b>RENK</b>	<b>COLOR</b>	<b>ÜRÜN KODU / CODE</b>
	-	Pres	Mill finish	SE.063.00.EXT
01	9016	Beyaz	White	SE.063.01.EXT
02	7038	Gri	Grey	SE.063.02.EXT
03	8014	Kahve	Brown	SE.063.03.EXT
04	9006	Metalik gri	Silver metallic	SE.063.04.EXT
08	1015	Krem	Ivory	SE.063.08.EXT
		Diğer RAL	Other RAL colors	SE.063.RA.EXT





## EKSTRÜZYON YÖNTEMİYLE ÜRETİLMİŞ ALÜMİNYUM PROFİLLER EXTRUDED ALUMINIUM PROFILES

ÜRÜN / ITEM	ÜRÜN ÖZELLİKLERİ		PRODUCT DESCRIPTION	
	<b>SE-78 PROFİL</b> Alüminyum ekstrüzyon profil (pencereli)		<b>SE-78 PROFILE</b> Extruded aluminium profile (perforated)	
	Nominal kalınlık Kapama yüzeyi Ağırlık (m <sup>2</sup> ) max. kullanım ölçüleri 1 m yükseklikteki profil adedi	17,34 mm 77 mm ~ 6,200 kg 5,50 x 4 m 12,99 (slats)		Nominal thickness Surface area Weight per sqm. max. usage sizes No. of slats per 1 m height
	SE-77 Ekstrüzyon alüminyum uyumlu			For Extruded aluminium SE-77
<b>AMBALAJ</b>	standart profil boyları 4.000 mm, 4.500 mm, 5.200 mm, 6.000 mm, 6.500 mm, 7.000 mm, 10 adetlik paketler halinde			
<b>PACKAGING</b>	bundles of 10 bars, standard lengths 4.000 mm, 4.500 mm, 5.200 mm, 6.000 mm, 6.500 mm, 7.000 mm.			

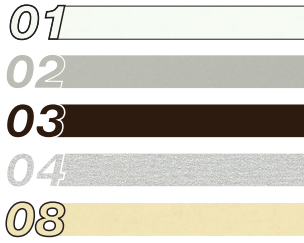

RAL NO	RENK	COLOR	ÜRÜN KODU / CODE
-	Pres	Mill finish	SE.078.00.EXT
9016	Beyaz	White	SE.078.01.EXT
7038	Gri	Grey	SE.078.02.EXT
8014	Kahve	Brown	SE.078.03.EXT
9006	Metalik gri	Silver metallic	SE.078.04.EXT
1015	Krem	Ivory	SE.078.08.EXT
	Diğer RAL	Other RAL colors	SE.078.RA.EXT

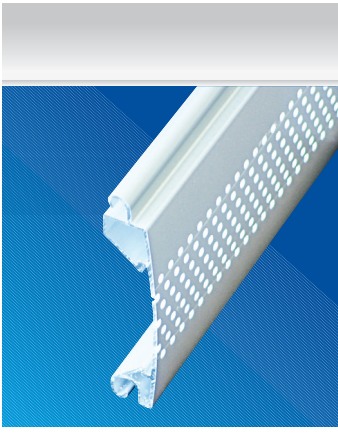

## EKSTRÜZYON YÖNTEMİYLE ÜRETİLMİŞ ALÜMİNYUM PROFİLLER EXTRUDED ALUMINIUM PROFILES

4

ÜRÜN / ITEM	ÜRÜN ÖZELLİKLERİ	PRODUCT DESCRIPTION		
	<b>SE-78 PROFİL</b> Alüminyum ekstrüzyon profil (mikro delikli)	<b>SE-78 PROFILE</b> Extruded aluminium profile (micro perforated)		
	Nominal kalınlık Kapama yüzeyi Ağırlık (m <sup>2</sup> ) max. kullanım ölçüleri 1 m yükseklikteki profil adedi	17,34 mm 77 mm ~ 7,300 kg 5,50 x 4 m 12,99 (slats)	Nominal thickness Surface area Weight per sqm. max. usage sizes No. of slats per 1 m height	
	SE-77 Ekstrüzyon alüminyum uyumlu	For Extruded aluminium SE-77		
<b>AMBALAJ</b>	standart profil boyları 4.000 mm, 4.500 mm, 5.200 mm, 6.000 mm, 6.500 mm, 7.000 mm, 5 adetlik paketler halinde			
<b>PACKAGING</b>	bundles of 5 bars, standard lengths 4.000 mm, 4.500 mm, 5.200 mm, 6.000 mm, 6.500 mm, 7.000 mm.			
RAL NO	RENK	COLOR	ÜRÜN KODU / CODE	
-	Pres	Mill finish	SE.078.00.MXT	
9016	Beyaz	White	SE.078.01.MXT	
7038	Gri	Grey	SE.078.02.MXT	
8014	Kahve	Brown	SE.078.03.MXT	
9006	Metalik gri	Silver metallic	SE.078.04.MXT	
1015	Krem	Ivory	SE.078.08.MXT	
	Diğer RAL	Other RAL colors	SE.078.RA.MXT	

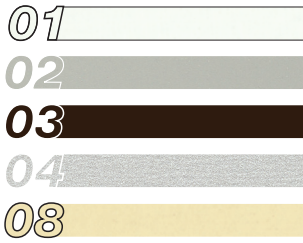

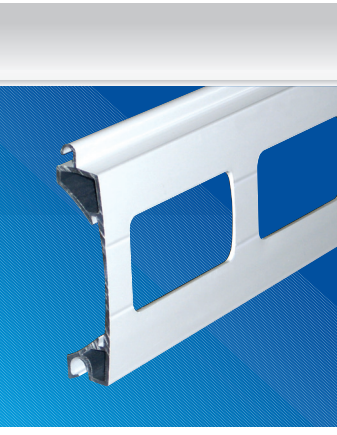

## EKSTRÜZYON YÖNTEMİYLE ÜRETİLMİŞ ALÜMİNYUM PROFİLLER EXTRUDED ALUMINIUM PROFILES

ÜRÜN / ITEM	ÜRÜN ÖZELLİKLERİ		PRODUCT DESCRIPTION
	<b>SL-78 PROFİL</b> Alüminyum ekstrüzyon profil (pencereli) SL serisi ile uyumlu  Nominal kalınlık 16,29 mm Kapama yüzeyi 77 mm Ağırlık (m <sup>2</sup> ) ~ 6,200 kg max. kullanım ölçüleri 5,50 x 3,50 m 1 m yükseklikteki profil adedi 12,99 (slats)		<b>SL-78 PROFILE</b> Extruded aluminium profile (perforated) matching with SL rollformed series  Nominal thickness 16,29 mm Surface area 77 mm Weight per sqm. ~ 6,200 kg max. usage sizes 5,50 x 3,50 m No. of slats per 1 m height 12,99 (slats)
	SL-77, ST-77 profil uyumlu		For profiles SL-77, ST-77
	<b>AMBALAJ</b>	standart profil boyları 4.000 mm, 4.500 mm, 5.200 mm, 6.000 mm, 6.500 mm, 7.000 mm, 10 adetlik paketler halinde	
<b>PACKAGING</b>	bundles of 10 bars, standard lengths 4.000 mm, 4.500 mm, 5.200 mm, 6.000 mm, 6.500 mm, 7.000 mm.		

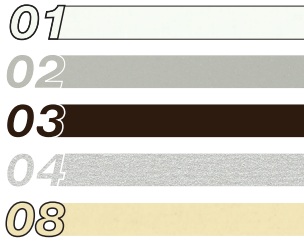

RAL NO	RENK	COLOR	ÜRÜN KODU / CODE
-	Pres	Mill finish	SE.078.00.EXP
9016	Beyaz	White	SE.078.01.EXP
7038	Gri	Grey	SE.078.02.EXP
8014	Kahve	Brown	SE.078.03.EXP
9006	Metalik gri	Silver metallic	SE.078.04.EXP
1015	Krem	Ivory	SE.078.08.EXP
	Diğer RAL	Other RAL colors	SE.078.RA.EXP

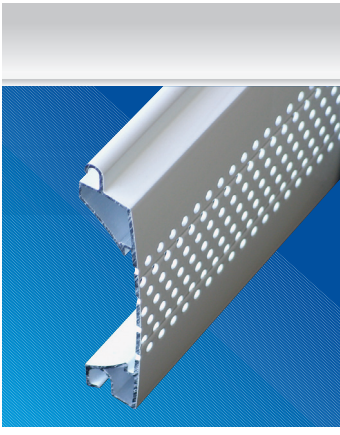

## EKSTRÜZYON YÖNTEMİYLE ÜRETİLMİŞ ALÜMİNYUM PROFİLLER EXTRUDED ALUMINIUM PROFILES

4

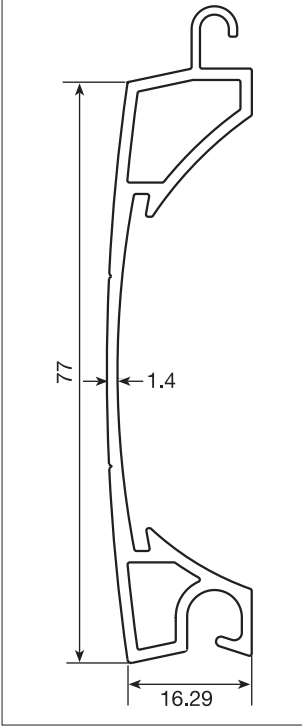
ÜRÜN / ITEM	ÜRÜN ÖZELLİKLERİ		PRODUCT DESCRIPTION
	<b>SL-78 PROFİL</b> Alüminyum ekstrüzyon profil (mikro delikli) SL serisi ile uyumlu		<b>SL-78 PROFILE</b> Extruded aluminium profile (micro perforated) matching with SL rollformed series
	Nominal kalınlık Kapama yüzeyi Ağırlık (m <sup>2</sup> ) max. kullanım ölçüleri 1 m yükseklikteki profil adedi	16,29 mm 77 mm ~ 7,300 kg 5,50 x 3,50 m 12,99 (slats)	Nominal thickness Surface area Weight per sqm. max. usage sizes No. of slats per 1 m height
	SL-77, ST-77 profil uyumlu		For profiles SL-77, ST-77
<b>AMBALAJ</b>	standart profil boyları 4.000 mm, 4.500 mm, 5.200 mm, 6.000 mm, 6.500 mm, 7.000 mm, 5 adetlik paketler halinde		
<b>PACKAGING</b>	bundles of 5 bars, standard lengths 4.000 mm, 4.500 mm, 5.200 mm, 6.000 mm, 6.500 mm, 7.000 mm.		
RAL NO	RENK	COLOR	ÜRÜN KODU / CODE
-	Pres	Mill finish	SE.078.00.MXP
9016	Beyaz	White	SE.078.01.MXP
7038	Gri	Grey	SE.078.02.MXP
8014	Kahve	Brown	SE.078.03.MXP
9006	Metalik gri	Silver metallic	SE.078.04.MXP
1015	Krem	Ivory	SE.078.08.MXP
	Diğer RAL	Other RAL colors	SE.078.RA.MXP

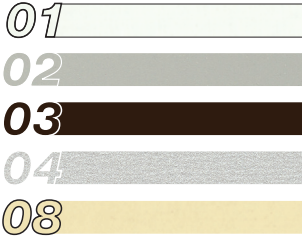



## EKSTRÜZYON YÖNTEMİYLE ÜRETİLMİŞ ALÜMİNYUM PROFİLLER EXTRUDED ALUMINIUM PROFILES

ÜRÜN / ITEM	ÜRÜN ÖZELLİKLERİ	PRODUCT DESCRIPTION	
	<b>SE-80 PROFİL</b> Alüminyum ekstrüzyon profil (pencere)li  Nominal kalınlık 14,7 mm Kapama yüzeyi 80 mm Ağırlık (m <sup>2</sup> ) ~ 8,100 kg max. kullanım ölçüleri 5,5 x 4 m 1 m yükseklikteki profil adedi 12,5 (slats)	<b>SE-80 PROFILE</b> Extruded aluminium profile (perforated)  Nominal thickness 14,7 mm Surface area 80 mm Weight per sqm. ~ 8,100 kg max. usage sizes 5,5 x 4 m No. of slats per 1 m height 12,5 (slats)	
	SE-77 alüminyum uyumlu	For aluminium SE-77	
	<b>AMBALAJ</b> standart profil boyları 4.000 mm, 4.500 mm, 5.200 mm, 6.000 mm, 6.500 mm, 7.000 mm, 10 adetlik paketler halinde	<b>PACKAGING</b> bundles of 10 bars, standard lengths 4.000 mm, 4.500 mm, 5.200 mm, 6.000 mm, 6.500 mm, 7.000 mm.	
RAL NO	RENK	COLOR	ÜRÜN KODU / CODE
-	Pres	Mill finish	SE.080.00.EXT
9016	Beyaz	White	SE.080.01.EXT
7038	Gri	Grey	SE.080.02.EXT
8014	Kahve	Brown	SE.080.03.EXT
9006	Metalik gri	Silver metallic	SE.080.04.EXT
1015	Krem	Ivory	SE.080.08.EXT
	Diğer RAL	Other RAL colors	SE.080.RA.EXT

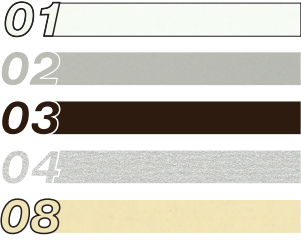



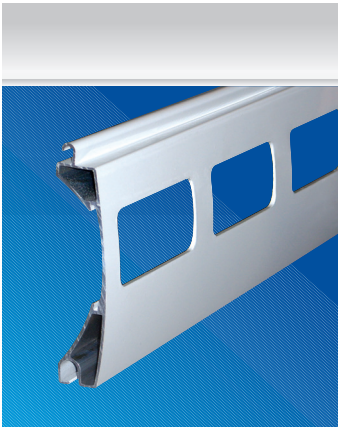

## EKSTRÜZYON YÖNTEMİYLE ÜRETİLMİŞ ALÜMİNYUM PROFİLLER *EXTRUDED ALUMINIUM PROFILES*

4

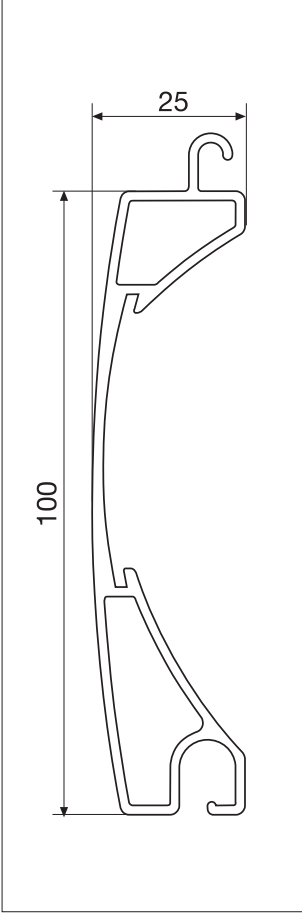
ÜRÜN / ITEM	ÜRÜN ÖZELLİKLERİ		PRODUCT DESCRIPTION
	<b>SE-101 PROFİL</b> Alüminyum ekstrüzyon profil (pencereli)		<b>SE-101 PROFILE</b> <i>Extruded aluminium profile (perforated)</i>
	Nominal kalınlık Kapama yüzeyi Ağırlık (m <sup>2</sup> ) max. kullanım ölçüleri 1 m yükseklikteki profil adedi	25 mm 100 mm ~9,50 kg 6 x 3,5 m 10 (slats)	<i>Nominal thickness Surface area Weight per sqm. max. usage sizes No. of slats per 1 m height</i>
	SE-100 alüminyum uyumlu		<i>For aluminium SE-100</i>
<b>AMBALAJ</b>	siparişe göre özel üretilir		
<b>PACKAGING</b>	<i>customize upon order</i>		
RAL NO	RENK	COLOR	ÜRÜN KODU / CODE
-	Pres	<i>Mill finish</i>	SE.101.00.EXT
9016	Beyaz	<i>White</i>	SE.101.01.EXT
7038	Gri	<i>Grey</i>	SE.101.02.EXT
8014	Kahve	<i>Brown</i>	SE.101.03.EXT
9006	Metalik gri	<i>Silver metallic</i>	SE.101.04.EXT
1015	Krem	<i>Ivory</i>	SE.101.08.EXT
	Diğer RAL	<i>Other RAL colors</i>	SE.101.RA.EXT

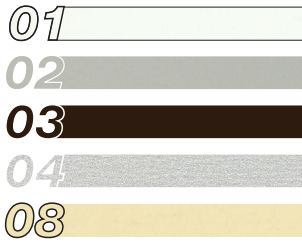

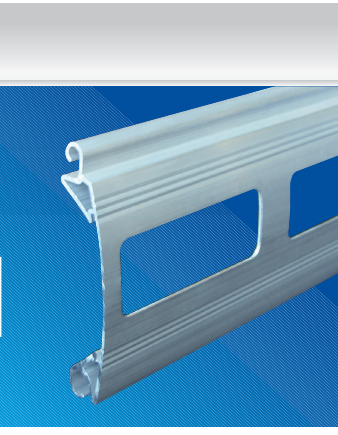

## EKSTRÜZYON YÖNTEMİYLE ÜRETİLMİŞ ALÜMİNYUM PROFİLLER EXTRUDED ALUMINIUM PROFILES

ÜRÜN / ITEM	ÜRÜN ÖZELLİKLERİ		PRODUCT DESCRIPTION	
	<b>SL-101 PROFİL</b> Alüminyum ekstrüzyon profil (pencereli)		<b>SL-101 PROFILE</b> Extruded aluminium profile (perforated)	
	Nominal kalınlık Kapama yüzeyi Ağırlık (m <sup>2</sup> ) max. kullanım ölçüleri 1 m yükseklikteki profil adedi	25,58 mm 96 mm ~ 8,80 kg 7 x 6 m 10,53 (slats)		Nominal thickness Surface area Weight per sqm. max. usage sizes No. of slats per 1 m height
	SL-100, ST-100 profil uyumlu		For profiles SL-100, ST-100	
	<b>AMBALAJ</b>	Standart palet boyları 5.200 mm, 6.000 mm, 6.500 mm, 7.000 mm 5 adetlik paketler halinde		
<b>PACKAGING</b>	Bundles of 5 bars standard lengths 5.200 mm, 6.000 mm, 6.500 mm, 7.000 mm			

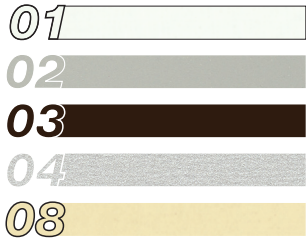

RAL NO	RENK	COLOR	ÜRÜN KODU / CODE
-	Pres	Mill finish	SE.101.00.EXP
9016	Beyaz	White	SE.101.01.EXP
7038	Gri	Grey	SE.101.02.EXP
8014	Kahve	Brown	SE.101.03.EXP
9006	Metalik gri	Silver metallic	SE.101.04.EXP
1015	Krem	Ivory	SE.101.08.EXP
	Diğer RAL	Other RAL colors	SE.101.RA.EXP



## EKSTRÜZYON YÖNTEMİYLE ÜRETİLMİŞ ALÜMİNYUM PROFİLLER *EXTRUDED ALUMINIUM PROFILES*

4

ÜRÜN / ITEM	ÜRÜN ÖZELLİKLERİ		PRODUCT DESCRIPTION	
	<b>SL-101 PROFİL</b> Alüminyum ekstrüzyon profil (mikro delikli)		<b>SL-101 PROFILE</b> <i>Extruded aluminium profile            (micro holes)</i>	
	Nominal kalınlık Kapama yüzeyi Ağırlık (m <sup>2</sup> ) max. kullanım ölçüleri 1 m yükseklikteki profil adedi	25,58 mm 96 mm ~ 8,900 kg 7 x 6 m 10,53 (slats)		<i>Nominal thickness            Surface area            Weight per sqm.            max. usage sizes            No. of slats per            1 m height</i>
	SL-100, ST-100 profil uyumlu		<i>For profiles SL-100, ST-100</i>	
<b>AMBALAJ</b>	Standart palet boyları 5.200 mm, 6.000 mm, 6.500 mm, 7.000 mm 5 adetlik paketler halinde			
<b>PACKAGING</b>	<i>Bundles of 5 bars standard lengths 5.200 mm, 6.000 mm, 6.500 mm, 7.000 mm</i>			

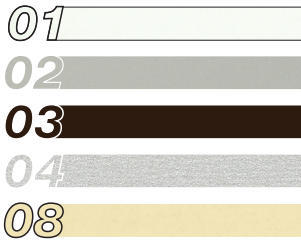

RAL NO	RENK	COLOR	ÜRÜN KODU / CODE
-	Pres	<i>Mill finish</i>	SE.101.00.MXP
9016	Beyaz	<i>White</i>	SE.101.01.MXP
7038	Gri	<i>Grey</i>	SE.101.02.MXP
8014	Kahve	<i>Brown</i>	SE.101.03.MXP
9006	Metalik gri	<i>Silver metallic</i>	SE.101.04.MXP
1015	Krem	<i>Ivory</i>	SE.101.08.MXP
	Diğer RAL	<i>Other RAL colors</i>	SE.101.RA.MXP

- 1
- 2
- 3
- 4
- 5
- 6
- 7
- 8
- 9
- 10
- 11
- 12
- 13
- 14
- 15
- 16
- 17
- 18
- 19
- 20
- 21
- 22
- 23
- 24
- 25
- 26
- 27
- 28
- 29

**Dikmeli "U" Profiller**  
*Guide Channels*

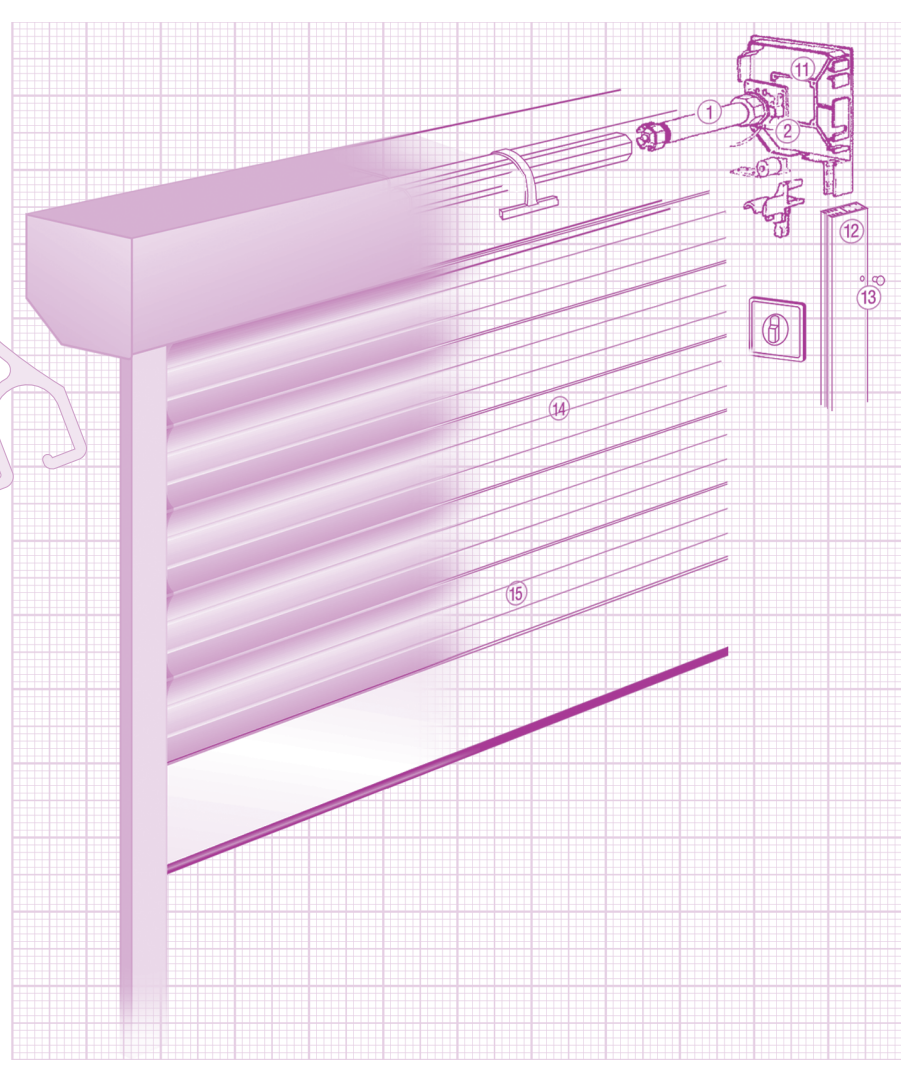
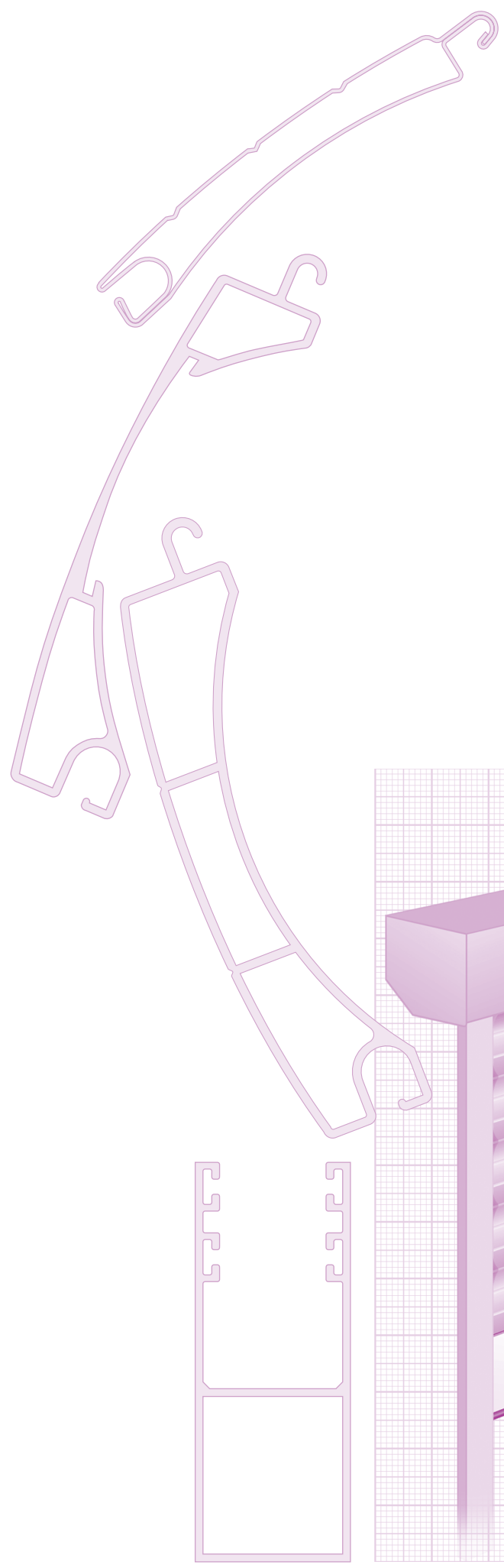

## DİKMELİ "U" PROFİLLER GUIDE CHANNELS

5

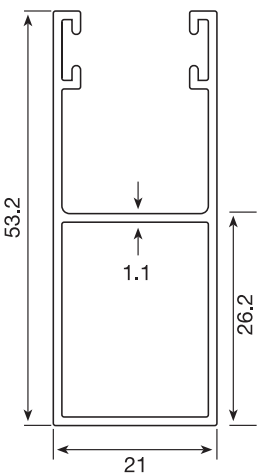
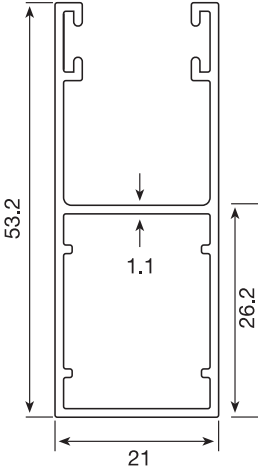
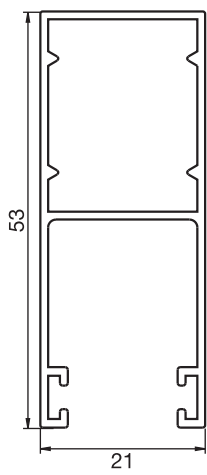
ÜRÜN İTEM	ÜRÜN ÖZELLİKLERİ PRODUCT DESCRIPTION	RENK COLOR	ÜRÜN KODU CODE			
	<p>Alüminyum ekstrüzyon dikmeli U profili SL-39, SL-41, SL-45, SE-45 için</p> <p><i>Extruded aluminium guide channel profiles for SL-39, SL-41, SL-45, SE-45</i></p>	<p>Pres <i>Mill finish</i></p> <p>Beyaz <i>White</i></p> <p>Gri <i>Grey</i></p> <p>Kahve <i>Brown</i></p> <p>Metalik gri <i>Silver metallic</i></p> <p>Krem <i>Ivory</i></p> <p>Seçilen RAL <i>Selected RAL</i></p>	<p>GC.424.00.DDU</p> <p>GC.424.01.DDU</p> <p>GC.424.02.DDU</p> <p>GC.424.03.DDU</p> <p>GC.424.04.DDU</p> <p>GC.424.08.DDU</p> <p>GC.424.RA.DDU</p>			
				<b>AMBALAJ</b>	standart boy 6.000 mm, 5 adetlik paketler halinde	
				<b>PACKAGING</b>	<i>bundles of 5 bars, standard length 6.000 mm</i>	
	<p>Alüminyum ekstrüzyon dikmeli U profili SL-39, SL-41, SL-45, SE-45 için</p> <p><i>Extruded aluminium guide channel profiles for SL-39, SL-41, SL-45, SE-45</i></p>	<p>Pres <i>Mill finish</i></p> <p>Beyaz <i>White</i></p> <p>Gri <i>Grey</i></p> <p>Kahve <i>Brown</i></p> <p>Metalik gri <i>Silver metallic</i></p> <p>Krem <i>Ivory</i></p> <p>Seçilen RAL <i>Selected RAL</i></p>	<p>GC.456.00.DDU</p> <p>GC.456.01.DDU</p> <p>GC.456.02.DDU</p> <p>GC.456.03.DDU</p> <p>GC.456.04.DDU</p> <p>GC.456.08.DDU</p> <p>GC.456.RA.DDU</p>			
				<b>AMBALAJ</b>	standart boy 6.000 mm, 5 adetlik paketler halinde	
				<b>PACKAGING</b>	<i>bundles of 5 bars, standard length 6.000 mm</i>	
	<p>Özel alüminyum ekstrüzyon dikmeli U profili SL-39, SL-41, SL-45, SE-45 için (53 x 21-UK)</p> <p><i>Customized aluminium extruded guide channel appropriate to SL-39, SL-41, SL-45, SE-45 (53 x 21-UK)</i></p>	<p>Pres <i>Mill finish</i></p> <p>Beyaz <i>White</i></p> <p>Gri <i>Gray</i></p> <p>Kahve <i>Brown</i></p> <p>Metalik Gri <i>Silver metallic</i></p> <p>Krem <i>Ivory</i></p> <p>Seçilen RAL <i>Selected RAL</i></p>	<p>GC.385.00.ODU</p> <p>GC.385.01.ODU</p> <p>GC.385.02.ODU</p> <p>GC.385.03.ODU</p> <p>GC.385.04.ODU</p> <p>GC.385.08.ODU</p> <p>GC.385.RA.ODU</p>			
				<b>AMBALAJ</b>	standart boylar 3.500, 4.700, 5.200, 6.000 mm, 3 adetlik paketler halinde	
				<b>PACKAGING</b>	<i>bundles of 3 bars, standard lengths 3.500, 4.700, 5.200, 6.000 mm</i>	

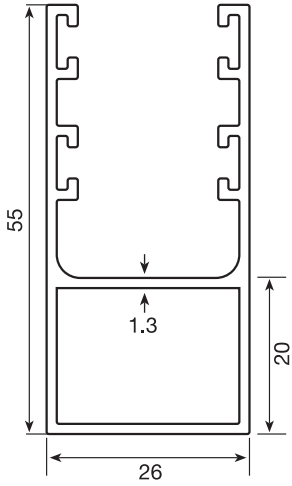
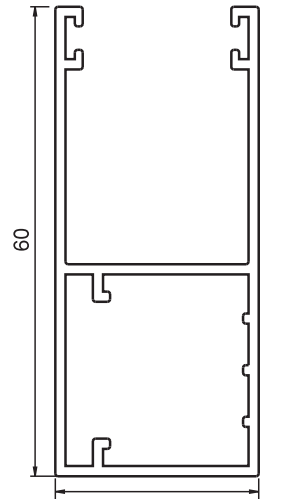

ÜRÜN İTEM	ÜRÜN ÖZELLİKLERİ PRODUCT DESCRIPTION	RENK COLOR	ÜRÜN KODU CODE
	<p>Özel alüminyum ekstrüzyon dikmeli U profili SL-39, SL-41, SL-45, SE-45 için (49 x 22-DE)</p> <p><i>Customized aluminium extruded guide channel appropriate to SL-39, SL-41, SL-45, SE-45 (49 x 22-DE)</i></p>	<p>Pres <i>Mill finish</i></p> <p>Beyaz <i>White</i></p> <p>Gri <i>Gray</i></p> <p>Kahve <i>Brown</i></p> <p>Metalik Gri <i>Silver metallic</i></p> <p>Krem <i>Ivory</i></p> <p>Seçilen RAL <i>Selected RAL</i></p>	<p>GC.365.00.ODU</p> <p>GC.365.01.ODU</p> <p>GC.365.02.ODU</p> <p>GC.365.03.ODU</p> <p>GC.365.04.ODU</p> <p>GC.365.08.ODU</p> <p>GC.365.RA.ODU</p>
	<b>AMBALAJ</b>	standart boylar 3.500, 4.700, 5.200, 6.000 mm, 3 adetlik paketler halinde	
	<b>PACKAGING</b>	<i>bundles of 3 bars, standard lengths 3.500, 4.700, 5.200, 6.000 mm</i>	
	<p>Özel alüminyum ekstrüzyon dikmeli U profili SL-39, SL-41, SL-45, SE-45 için (53,5 x 22-DE)</p> <p><i>Customized aluminium extruded guide channel appropriate to SL-39, SL-41, SL-45, SE-45 (53,5 x 22-DE)</i></p>	<p>Pres <i>Mill finish</i></p> <p>Beyaz <i>White</i></p> <p>Gri <i>Gray</i></p> <p>Kahve <i>Brown</i></p> <p>Metalik Gri <i>Silver metallic</i></p> <p>Krem <i>Ivory</i></p> <p>Seçilen RAL <i>Selected RAL</i></p>	<p>GC.366.00.ODU</p> <p>GC.366.01.ODU</p> <p>GC.366.02.ODU</p> <p>GC.366.03.ODU</p> <p>GC.366.04.ODU</p> <p>GC.366.08.ODU</p> <p>GC.366.RA.ODU</p>
	<b>AMBALAJ</b>	standart boylar 3.500, 4.700, 5.200, 6.000 mm, 3 adetlik paketler halinde	
	<b>PACKAGING</b>	<i>bundles of 3 bars, standard lengths 3.500, 4.700, 5.200, 6.000 mm</i>	
	<p>Alüminyum ekstrüzyon köşebentli, dikmeli U profili SL-39, SL-41, SL-45, SE-45 için</p> <p><i>Extruded aluminium guide channel profiles for SL-39, SL-41, SL-45, SE-45 with angle</i></p>	<p>Pres <i>Mill finish</i></p> <p>Beyaz <i>White</i></p> <p>Gri <i>Grey</i></p> <p>Kahve <i>Brown</i></p> <p>Metalik gri <i>Silver metallic</i></p> <p>Krem <i>Ivory</i></p> <p>Seçilen RAL <i>Selected RAL</i></p>	<p>GC.445.00.KDU</p> <p>GC.445.01.KDU</p> <p>GC.445.02.KDU</p> <p>GC.445.03.KDU</p> <p>GC.445.04.KDU</p> <p>GC.445.08.KDU</p> <p>GC.445.RA.KDU</p>
	<b>AMBALAJ</b>	standart boy 6.000 mm, 5 adetlik paketler halinde	
	<b>PACKAGING</b>	<i>bundles of 5 bars, standard length 6.000 mm</i>	

ÜRÜN İTEM	ÜRÜN ÖZELLİKLERİ PRODUCT DESCRIPTION	RENK COLOR	ÜRÜN KODU CODE
	<p>Alüminyum ekstrüzyon dikmeli U profili SL-55, SL-56, SE-60, SE-62, SE-63, ST-56 için</p> <p><i>Extruded aluminium guide channel profiles for SL-55, SL-56, SE-60, SE-62, SE-63, ST-56</i></p>	<p>Pres <i>Mill finish</i> Beyaz <i>White</i> Gri <i>Grey</i> Kahve <i>Brown</i> Metalik gri <i>Silver metallic</i> Krem <i>Ivory</i> Seçilen RAL <i>Selected RAL</i></p>	<p>GC.435.00.ODU GC.435.01.ODU GC.435.02.ODU GC.435.03.ODU GC.435.04.ODU GC.435.08.ODU GC.435.RA.ODU</p>
	<p><b>AMBALAJ</b> standart boy 6.000 mm, 5 adetlik paketler halinde</p> <p><b>PACKAGING</b> <i>bundles of 5 bars, standard length 6.000 mm</i></p>		
	<p>Özel alüminyum ekstrüzyon dikmeli U profili SL-55, SL-56, SE-62, SE-63, ST-56 için (55 x 26-UK)</p> <p><i>Customized aluminium extruded guide channel appropriate to SL-55, SL-56, SE-62, SE-63, ST-56 (55 x 26-UK)</i></p>	<p>Pres <i>Mill finish</i> Beyaz <i>White</i> Gri <i>Gray</i> Kahve <i>Brown</i> Metalik Gri <i>Silver metallic</i> Krem <i>Ivory</i> Seçilen RAL <i>Selected RAL</i></p>	<p>GC.457.00.ODU GC.457.01.ODU GC.457.02.ODU GC.457.03.ODU GC.457.04.ODU GC.457.08.ODU GC.457.RA.ODU</p>
<p><b>AMBALAJ</b> standart boylar 3.500, 4.700, 5.200, 6.000 mm, 3 adetlik paketler halinde</p> <p><b>PACKAGING</b> <i>bundles of 3 bars, standard lengths 3.500, 4.700, 5.200, 6.000 mm</i></p>			
	<p>Özel alüminyum ekstrüzyon dikmeli U profili SL-55, SL-56, SE-62, SE-63, ST-56 için (60 x 26-UK)</p> <p><i>Customized aluminium extruded guide channel appropriate to SL-55, SL-56, SE-62, SE-63, ST-56 (60 x 26-UK)</i></p>	<p>Pres <i>Mill finish</i> Beyaz <i>White</i> Gri <i>Gray</i> Kahve <i>Brown</i> Metalik Gri <i>Silver metallic</i> Krem <i>Ivory</i> Seçilen RAL <i>Selected RAL</i></p>	<p>GC.390.00.ODU GC.390.01.ODU GC.390.02.ODU GC.390.03.ODU GC.390.04.ODU GC.390.08.ODU GC.390.RA.ODU</p>
	<p><b>AMBALAJ</b> standart boylar 3.500, 4.700, 5.200, 6.000 mm, 3 adetlik paketler halinde</p> <p><b>PACKAGING</b> <i>bundles of 3 bars, standard lengths 3.500, 4.700, 5.200, 6.000 mm</i></p>		

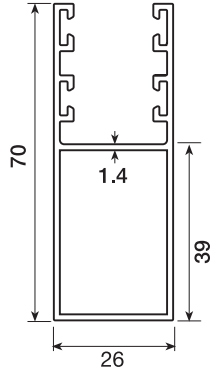
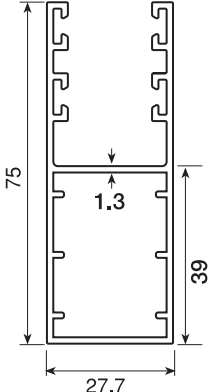
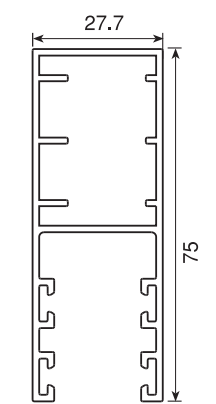
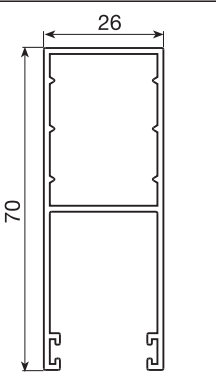
ÜRÜN İTEM	ÜRÜN ÖZELLİKLERİ PRODUCT DESCRIPTION	RENK COLOR	ÜRÜN KODU CODE
	<p>Alüminyum ekstrüzyon dikmeli U profili SL-55, SL-56, SE-60, SE-62, SE-63, ST-56 için</p> <p><i>Extruded aluminium guide channel profiles for SL-55, SL-56, SE-60, SE-62, SE-63, ST-56</i></p>	<p>Pres <i>Mill finish</i> Beyaz <i>White</i> Gri <i>Grey</i> Kahve <i>Brown</i> Metalik gri <i>Silver metallic</i> Krem <i>Ivory</i> Seçilen RAL <i>Selected RAL</i></p>	<p>GC.403.00.NDU GC.403.01.NDU GC.403.02.NDU GC.403.03.NDU GC.403.04.NDU GC.403.08.NDU GC.403.RA.NDU</p>
	<b>AMBALAJ</b>	standart boy 6.000 mm, 5 adetlik paketler halinde	
	<b>PACKAGING</b>	<i>bundles of 5 bars, standard length 6.000 mm</i>	
	<p>Alüminyum ekstrüzyon dikmeli U profili SL-55, SL-56, SE-60, SE-62, SE-63, ST-56 için</p> <p><i>Extruded aluminium guide channel profiles for SL-55, SL-56, SE-60, SE-62, SE-63, ST-56</i></p>	<p>Pres <i>Mill finish</i> Beyaz <i>White</i> Gri <i>Grey</i> Kahve <i>Brown</i> Metalik gri <i>Silver metallic</i> Krem <i>Ivory</i> Seçilen RAL <i>Selected RAL</i></p>	<p>GC.422.00.NDU GC.422.01.NDU GC.422.02.NDU GC.422.03.NDU GC.422.04.NDU GC.422.08.NDU GC.422.RA.NDU</p>
	<b>AMBALAJ</b>	standart boylar 4.700, 5.200, 6.000 mm, 4 adetlik paketler halinde	
	<b>PACKAGING</b>	<i>bundles of 4 bars, standard lengths 4.700, 5.200, 6.000 mm</i>	
	<p>Özel alüminyum ekstrüzyon dikmeli U profili SL-55, SL-56, SE-62, SE-63, ST-56 için (75 x 27,7-UK)</p> <p><i>Customized aluminium extruded guide channel appropriate to SL-55, SL-56, SE-62, SE-63, ST-56 (75 x 27,7-UK)</i></p>	<p>Pres <i>Mill finish</i> Beyaz <i>White</i> Gri <i>Gray</i> Kahve <i>Brown</i> Metalik Gri <i>Silver metallic</i> Krem <i>Ivory</i> Seçilen RAL <i>Selected RAL</i></p>	<p>GC.417.00.ODU GC.417.01.ODU GC.417.02.ODU GC.417.03.ODU GC.417.04.ODU GC.417.08.ODU GC.417.RA.ODU</p>
	<b>AMBALAJ</b>	standart boylar 3.500, 4.700, 5.200, 6.000 mm, 3 adetlik paketler halinde	
	<b>PACKAGING</b>	<i>bundles of 3 bars, standard lengths 3.500, 4.700, 5.200, 6.000 mm</i>	
	<p>Özel alüminyum ekstrüzyon dikmeli U profili SL-55, SL-56, SE-62, SE-63, ST-56 için (70 x 26-UK)</p> <p><i>Customized aluminium extruded guide channel appropriate to SL-55, SL-56, SE-62, SE-63, ST-56 (70 x 26-UK)</i></p>	<p>Pres <i>Mill finish</i> Beyaz <i>White</i> Gri <i>Gray</i> Kahve <i>Brown</i> Metalik Gri <i>Silver metallic</i> Krem <i>Ivory</i> Seçilen RAL <i>Selected RAL</i></p>	<p>GC.391.00.ODU GC.391.01.ODU GC.391.02.ODU GC.391.03.ODU GC.391.04.ODU GC.391.08.ODU GC.391.RA.ODU</p>
	<b>AMBALAJ</b>	standart boylar 3.500, 4.700, 5.200, 6.000 mm, 3 adetlik paketler halinde	
	<b>PACKAGING</b>	<i>bundles of 3 bars, standard lengths 3.500, 4.700, 5.200, 6.000 mm</i>	

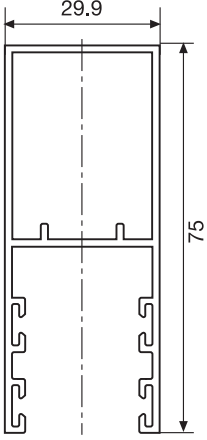
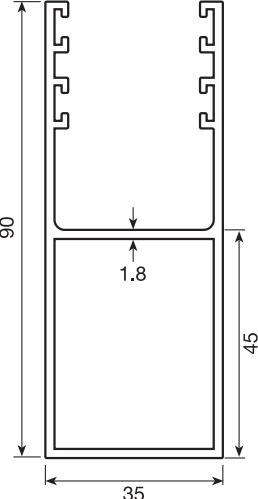
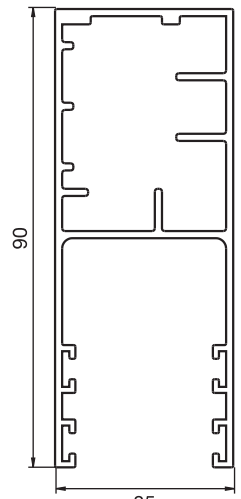
ÜRÜN İTEM	ÜRÜN ÖZELLİKLERİ PRODUCT DESCRIPTION	RENK COLOR	ÜRÜN KODU CODE
	<p>Alüminyum ekstrüzyon dikmeli U profili SE-E62 için</p> <p><i>Extruded aluminium guide channel profiles for SE-E62</i></p>	<p>Pres <i>Mill finish</i> Beyaz <i>White</i> Gri <i>Gray</i> Kahve <i>Brown</i> Metalik Gri <i>Silver metallic</i> Krem <i>Ivory</i> Seçilen RAL <i>Selected RAL</i></p>	<p>GC.476.00.NDU GC.476.01.NDU GC.476.02.NDU GC.476.03.NDU GC.476.04.NDU GC.476.08.NDU GC.476.RA.NDU</p>
	<b>AMBALAJ</b>	standart boylar 3.500, 4.700, 5.200, 6.000 mm, 3 adetlik paketler halinde	
	<b>PACKAGING</b>	<i>bundles of 3 bars, standard lengths 3.500, 4.700, 5.200, 6.000 mm</i>	
	<p>Alüminyum ekstrüzyon dikmeli U profili SL-75, SL-77, ST-77, SE-77, SE-78, SE-80 için</p> <p><i>Extruded aluminium guide channel profiles for SL-75, SL-77, ST-77, SE-77, SE-78, SE-80</i></p>	<p>Pres <i>Mill finish</i> Beyaz <i>White</i> Gri <i>Gray</i> Kahve <i>Brown</i> Metalik gri <i>Silver metallic</i> Krem <i>Ivory</i> Seçilen RAL <i>Selected RAL</i></p>	<p>GC.429.00.GDU GC.429.01.GDU GC.429.02.GDU GC.429.03.GDU GC.429.04.GDU GC.429.08.GDU GC.429.RA.GDU</p>
	<b>AMBALAJ</b>	standart boylar 3.500, 4.700, 5.200, 6.000 mm, 3 adetlik paketler halinde	
	<b>PACKAGING</b>	<i>bundles of 3 bars, standard lengths 3.500, 4.700, 5.200, 6.000 mm</i>	
	<p>Özel alüminyum ekstrüzyon dikmeli U profili SL-75, SL-77, ST-77, SE-77, SE-78 için (90 x 35-DE)</p> <p><i>Customized aluminium extruded guide channel appropriate to SL-75, SL-77, ST-77, SE-77, SE-78 (90 x 35-DE)</i></p>	<p>Pres <i>Mill finish</i> Beyaz <i>White</i> Gri <i>Gray</i> Kahve <i>Brown</i> Metalik Gri <i>Silver metallic</i> Krem <i>Ivory</i> Seçilen RAL <i>Selected RAL</i></p>	<p>GC.362.00.ODU GC.362.01.ODU GC.362.02.ODU GC.362.03.ODU GC.362.04.ODU GC.362.08.ODU GC.362.RA.ODU</p>
	<b>AMBALAJ</b>	standart boylar 3.500, 4.700, 5.200, 6.000 mm, 3 adetlik paketler halinde	
	<b>PACKAGING</b>	<i>bundles of 3 bars, standard lengths 3.500, 4.700, 5.200, 6.000 mm</i>	

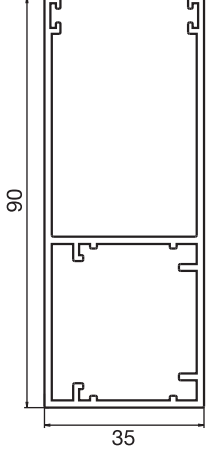
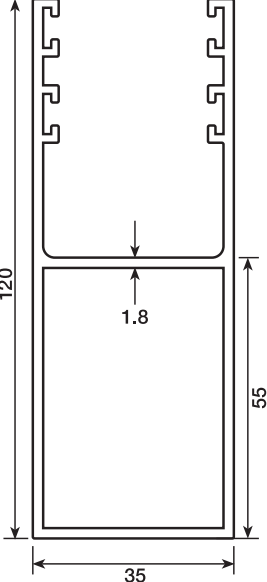
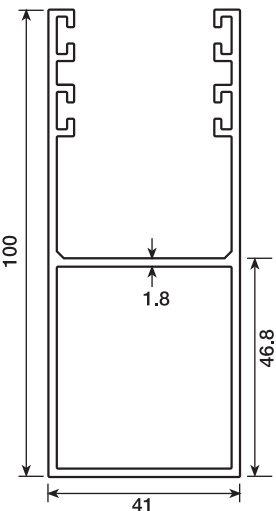
ÜRÜN İTEM	ÜRÜN ÖZELLİKLERİ PRODUCT DESCRIPTION	RENK COLOR	ÜRÜN KODU CODE
	<p>Özel alüminyum ekstrüzyon dikmeli U profili SL-75, SL-77, ST-77, SE-77, SE-78 için (90 x 35-UK)</p> <p><i>Customized aluminium extruded guide channel appropriate to SL-75, SL-77, ST-77, SE-77, SE-78 (90 x 35-UK)</i></p>	<p>Pres <i>Mill finish</i> Beyaz <i>White</i> Gri <i>Gray</i> Kahve <i>Brown</i> Metalik Gri <i>Silver metallic</i> Krem <i>Ivory</i> Seçilen RAL <i>Selected RAL</i></p>	<p>GC.392.00.ODU GC.392.01.ODU GC.392.02.ODU GC.392.03.ODU GC.392.04.ODU GC.392.08.ODU GC.392.RA.ODU</p>
	<p><b>AMBALAJ</b> standart boylar 3.500, 4.700, 5.200, 6.000 mm, 3 adetlik paketler halinde</p> <p><b>PACKAGING</b> <i>bundles of 3 bars, standard lengths 3.500, 4.700, 5.200, 6.000 mm</i></p>		
	<p>Alüminyum ekstrüzyon dikmeli U profili SL-75, SL-77, ST-77, SE-77, SE-78, SE-80 için</p> <p><i>Extruded aluminium guide channel profiles for SL-75, SL-77, ST-77, SE-77, SE-78, SE-80</i></p>	<p>Pres <i>Mill finish</i> Beyaz <i>White</i> Gri <i>Grey</i> Kahve <i>Brown</i> Metalik gri <i>Silver metallic</i> Krem <i>Ivory</i> Seçilen RAL <i>Selected RAL</i></p>	<p>GC.459.00.GDU GC.459.01.GDU GC.459.02.GDU GC.459.03.GDU GC.459.04.GDU GC.459.08.GDU GC.459.RA.GDU</p>
	<p><b>AMBALAJ</b> standart boylar 3.500, 4.700, 5.200, 6.000 mm, 3 adetlik paketler halinde</p> <p><b>PACKAGING</b> <i>bundles of 3 bars, standard lengths 3.500, 4.700, 5.200, 6.000 mm</i></p>		
	<p>Alüminyum ekstrüzyon dikmeli U profili ST-100, SL-100, SL-75, SL-77, ST-77, SE-77, SE-78, SE-80 için</p> <p><i>Extruded aluminium guide channel profiles for ST-100, SL-100, SL-75, SL-77, ST-77, SE-77, SE-78, SE-80</i></p>	<p>Pres <i>Mill finish</i> Beyaz <i>White</i> Gri <i>Grey</i> Kahve <i>Brown</i> Metalik gri <i>Silver metallic</i> Krem <i>Ivory</i> Seçilen RAL <i>Selected RAL</i></p>	<p>GC.438.00.XGU GC.438.01.XGU GC.438.02.XGU GC.438.03.XGU GC.438.04.XGU GC.438.08.XGU GC.438.RA.XGU</p>
	<p><b>AMBALAJ</b> standart boylar 5.200, 6.000, 6.500 mm, 3 adetlik paketler halinde</p> <p><b>PACKAGING</b> <i>bundles of 3 bars, standard lengths 5.200, 6.000, 6.500 mm</i></p>		

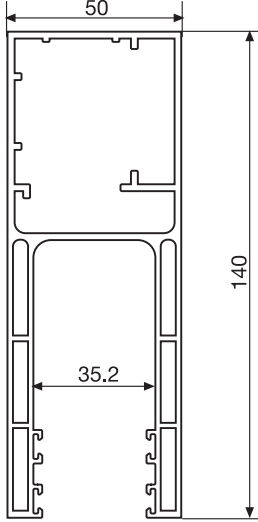
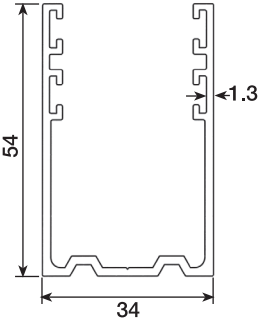
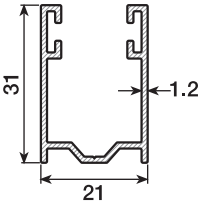
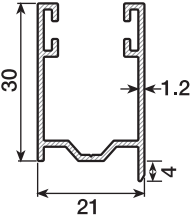

ÜRÜN İTEM	ÜRÜN ÖZELLİKLERİ PRODUCT DESCRIPTION	RENK COLOR	ÜRÜN KODU CODE	
	<p>Alüminyum ekstrüzyon dikmeli U profili ST-100, SL-100, SL-101, SE-100, SE-101 için</p> <p><i>Extruded aluminium guide channel profiles for ST-100, SL100, SL-101, SE-100, SE-101</i></p>	<p>Pres <i>Mill finish</i> Beyaz <i>White</i> Gri <i>Grey</i> Kahve <i>Brown</i> Metalik gri <i>Silver metallic</i> Krem <i>Ivory</i> Seçilen RAL <i>Selected RAL</i></p>	<p>GC.482.00.XGU GC.482.01.XGU GC.482.02.XGU GC.482.03.XGU GC.482.04.XGU GC.482.08.XGU GC.482.RA.XGU</p>	
	<b>AMBALAJ</b>	standart boy 6.000 mm, 2 adetlik paketler halinde		
	<b>PACKAGING</b>	<i>bundles of 2 bars, standard length 6.000 mm</i>		
	<p>Alüminyum ekstrüzyon dikmesiz U profili SL-75, SL-77, ST-77, SE-77, SE-78, SE-80 için</p> <p><i>Extruded aluminium guide channel profiles for SL-75, SL-77, ST-77, SE-77, SE-78, SE-80</i></p>	<p>Pres <i>Mill finish</i> Beyaz <i>White</i> Gri <i>Grey</i> Kahve <i>Brown</i> Metalik gri <i>Silver metallic</i> Krem <i>Ivory</i> Seçilen RAL <i>Selected RAL</i></p>	<p>GC.418.00.ZDU GC.418.01.ZDU GC.418.02.ZDU GC.418.03.ZDU GC.418.04.ZDU GC.418.08.ZDU GC.418.RA.ZDU</p>	
	<b>AMBALAJ</b>	standart boy 6.000 mm, 10 adetlik paketler halinde		
	<b>PACKAGING</b>	<i>bundles of 10 bars, standard length 6.000 mm</i>		
	<p>Alüminyum ekstrüzyon fitilli U profili SL-39, SL-41, SL-45 için</p> <p><i>Extruded aluminium guide without box for SL-39, SL-41, SL-45</i></p>	<p>Pres <i>Mill finish</i> Beyaz <i>White</i> Gri <i>Grey</i> Kahve <i>Brown</i> Metalik gri <i>Silver metallic</i> Krem <i>Ivory</i> Seçilen RAL <i>Selected RAL</i></p>	<p>GC.432.00.ZDU GC.432.01.ZDU GC.432.02.ZDU GC.432.03.ZDU GC.432.04.ZDU GC.432.08.ZDU GC.432.RA.ZDU</p>	
	<b>AMBALAJ</b>	standart boy 6.000 mm, 10 adetlik paketler halinde		
	<b>PACKAGING</b>	<i>bundles of 10 bars, standard length 6.000 mm</i>		
	<p>Alüminyum ekstrüzyon fitilli, tırnaklı U profili SL-39, için</p> <p><i>Extruded aluminium guide without box with nail for SL-39,</i></p>	<p>Pres <i>Mill finish</i> Beyaz <i>White</i> Gri <i>Grey</i> Kahve <i>Brown</i> Metalik gri <i>Silver metallic</i> Krem <i>Ivory</i> Seçilen RAL <i>Selected RAL</i></p>	<p>GC.414.00.TDU GC.414.01.TDU GC.414.02.TDU GC.414.03.TDU GC.414.04.TDU GC.414.08.TDU GC.414.RA.TDU</p>	
	<b>AMBALAJ</b>	standart boy 6.500 mm, 10 adetlik paketler halinde		
	<b>PACKAGING</b>	<i>bundles of 10 bars, standard length 6.000 mm</i>		

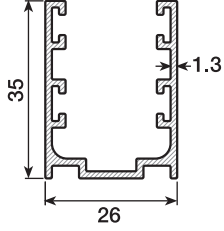
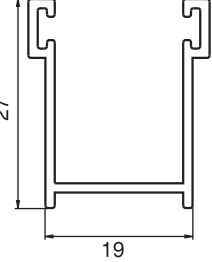
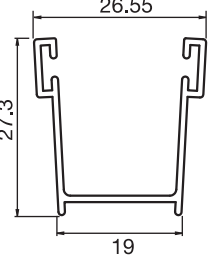
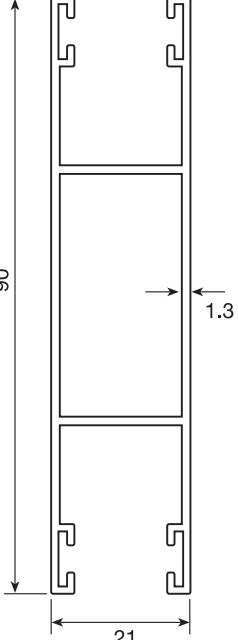
ÜRÜN İTEM	ÜRÜN ÖZELLİKLERİ PRODUCT DESCRIPTION	RENK COLOR	ÜRÜN KODU CODE
	<p>Alüminyum ekstrüzyon çift fitilli, U profili SL-55, SL-56, SE-62, SE-63, ST-56 için</p> <p><i>Extruded aluminium guide without box for SL-55, SL-56, SE-62, SE-63, ST-56</i></p>	<p>Pres <i>Mill finish</i> Beyaz <i>White</i> Gri <i>Grey</i> Kahve <i>Brown</i> Metalik gri <i>Silver metallic</i> Krem <i>Ivory</i> Seçilen RAL <i>Selected RAL</i></p>	<p>GC.433.00.ZDU GC.433.01.ZDU GC.433.02.ZDU GC.433.03.ZDU GC.433.04.ZDU GC.433.08.ZDU GC.433.RA.ZDU</p>
	<p><b>AMBALAJ</b> standart boy 6.500 mm, 10 adetlik paketler halinde</p>		
	<p><b>PACKAGING</b> <i>bundles of 10 bars, standard length 6.000 mm</i></p>		
	<p>Alüminyum ekstrüzyon fitilli U profili SL-39 için (27 x 23,4)</p> <p><i>Aluminium extruded guide channel with brush insert appropriate to SL-39 (27 x 23,4)</i></p>	PRES	GC.386.00.ZDU
	<p><b>AMBALAJ</b> standart boylar 3.500, 4.700, 5.200, 6.000 mm, 3 adetlik paketler halinde</p>		
	<p><b>PACKAGING</b> <i>bundles of 3 bars, standard lengths 3.500, 4.700, 5.200, 6.000 mm</i></p>		
	<p>Özel alüminyum ekstrüzyon fitilli U profili SL-55, SL-56 için (27,3x25,75)</p> <p><i>Customized aluminium extruded guide channel with brush insert appropriate to SL-55, SL 56 (27,3x25,75)</i></p>	PRES	GC.284.00.ZDU
	<p><b>AMBALAJ</b> standart boylar 6.000 mm, 3 adetlik paketler halinde</p>		
	<p><b>PACKAGING</b> <i>bundles of 3 bars, standard lengths 6.000 mm</i></p>		
	<p>Alüminyum ekstrüzyon çift kanallı dikmeli U profili (orta H profil) SL-39, SL-41, SL-45, SE-45 için</p> <p><i>Extruded aluminium guide channel profiles for SL-39, SL-41, SL-45 SE-45 double guide</i></p>	<p>Pres <i>Mill finish</i> Beyaz <i>White</i> Gri <i>Grey</i> Kahve <i>Brown</i> Metalik gri <i>Silver metallic</i> Krem <i>Ivory</i> Seçilen RAL <i>Selected RAL</i></p>	<p>GC.419.00.DOU GC.419.01.DOU GC.419.02.DOU GC.419.03.DOU GC.419.04.DOU GC.419.08.DOU GC.419.RA.DOU</p>
	<p><b>AMBALAJ</b> standart boy 6.500 mm, 5 adetlik paketler halinde</p>		
	<p><b>PACKAGING</b> <i>bundles of 5 bars, standard length 6.000 mm</i></p>		

ÜRÜN İTEM	ÜRÜN ÖZELLİKLERİ PRODUCT DESCRIPTION	RENK COLOR	ÜRÜN KODU CODE
	<p>Alüminyum ekstrüzyon çift kanallı, dikmeli U profili (orta H profil) SL-55, SL-56, SE-60, SE-62, SE-63, ST-56 için</p> <p><i>Extruded aluminium guide channel profiles for SL-55, SL-56, SE-60, SE-62, SE-63, ST-56 double guide (middle H profile)</i></p>	<p>Pres <i>Mill finish</i> Beyaz <i>White</i> Gri <i>Grey</i> Kahve <i>Brown</i> Metalik gri <i>Silver metallic</i> Krem <i>Ivory</i> Seçilen RAL <i>Selected RAL</i></p>	<p>GC.453.00.DOU GC.453.01.DOU GC.453.02.DOU GC.453.03.DOU GC.453.04.DOU GC.453.08.DOU GC.453.RA.DOU</p>
	<p><b>AMBALAJ</b> standart boy 6.000 mm, 4 adetlik paketler halinde</p>		
	<p><b>PACKAGING</b> <i>bundles of 4 bars, standard length 6.000 mm</i></p>		
	<p>Monoblok pvc kutu alüminyum SKS dikmeli U profili SL-39, SL-41, SL-45, SL-55, SL-56 için</p> <p><i>Aluminium SKS guide channel for monoblock PVC box appropriate to SL-39, SL-41, SL-45, SL-55, SL-56</i></p>	<p>Pres <i>Mill finish</i> Beyaz <i>White</i> Gri <i>Gray</i> Kahve <i>Brown</i> Metalik Gri <i>Silver metallic</i> Krem <i>Ivory</i> Seçilen RAL <i>Selected RAL</i></p>	<p>GC.383.00.MON GC.383.01.MON GC.383.02.MON GC.383.03.MON GC.383.04.MON GC.383.08.MON GC.383.RA.MON</p>
	<p><b>AMBALAJ</b> standart boylar 6.000 mm, 3 adetlik paketler halinde</p>		
	<p><b>PACKAGING</b> <i>bundles of 3 bars, standard lengths 6.000 mm</i></p>		
	<p>Monoblok pvc kutu alüminyum SKS orta dikmeli U profili SL-39, SL-41, SL-45, SE-45, SL-55, SL-56 için</p> <p><i>Aluminium SKS middle guide channel for monoblock PVC box appropriate to SL-39, SL-41, SL-45, SE-45, SL-55, SL-56</i></p>	<p>Pres <i>Mill finish</i> Beyaz <i>White</i> Gri <i>Gray</i> Kahve <i>Brown</i> Metalik Gri <i>Silver metallic</i> Krem <i>Ivory</i> Seçilen RAL <i>Selected RAL</i></p>	<p>GC.384.00.MON GC.384.01.MON GC.384.02.MON GC.384.03.MON GC.384.04.MON GC.384.08.MON GC.384.RA.MON</p>
	<p><b>AMBALAJ</b> standart boylar 6.000 mm, 3 adetlik paketler halinde</p>		
	<p><b>PACKAGING</b> <i>bundles of 3 bars, standard lengths 6.000 mm</i></p>		



**Alt Parçalar**

*End Slats*

- 1
- 2
- 3
- 4
- 5
- 6
- 7
- 8
- 9
- 10
- 11
- 12
- 13
- 14
- 15
- 16
- 17
- 18
- 19
- 20
- 21
- 22
- 23
- 24
- 25
- 26
- 27
- 28
- 29

## ALT PARÇALAR END SLATS

6

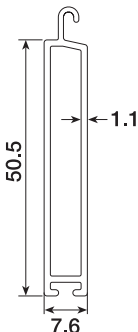
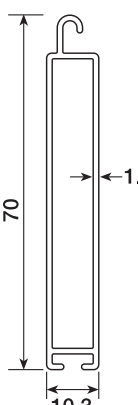
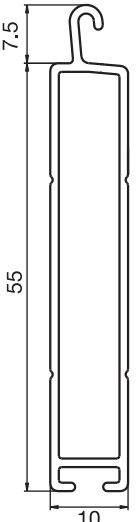
ÜRÜN İTEM	ÜRÜN ÖZELLİKLERİ PRODUCT DESCRIPTION	RENK COLOR	ÜRÜN KODU CODE	
	<p>Alüminyum ekstrüzyon alt parça SL-39, SL-41, SL-45, SL-56, SE-45 için</p> <p><i>Aluminium extruded end slat for SL-39, SL-41, SL-45, SL-56, SE-45</i></p>	<p>Pres <i>Mill finish</i> Beyaz <i>White</i> Gri <i>Grey</i> Kahve <i>Brown</i> Metalik gri <i>Silver metallic</i> Krem <i>Ivory</i> Seçilen RAL <i>Selected RAL</i></p>	<p>ES.427.00.DAP ES.427.01.DAP ES.427.02.DAP ES.427.03.DAP ES.427.04.DAP ES.427.08.DAP ES.427.RA.DAP</p>	
	<b>AMBALAJ</b>	standart boy 6.000 mm, 10 adetlik paketler halinde		
	<b>PACKAGING</b>	<i>bundles of 10 bars, standard length 6.000 mm</i>		
	<p>Alüminyum ekstrüzyon alt parça SL-55, ST-56, SE-60, SE-62, SE-63 için</p> <p><i>Aluminium extruded end slat for SL-55, ST-56, SE-60, SE-62, SE-63</i></p>	<p>Pres <i>Mill finish</i> Beyaz <i>White</i> Gri <i>Grey</i> Kahve <i>Brown</i> Metalik gri <i>Silver metallic</i> Krem <i>Ivory</i> Seçilen RAL <i>Selected RAL</i></p>	<p>ES.426.00.NAP ES.426.01.NAP ES.426.02.NAP ES.426.03.NAP ES.426.04.NAP ES.426.08.NAP ES.426.RA.NAP</p>	
	<b>AMBALAJ</b>	standart boy 6.000 mm, 10 adetlik paketler halinde		
	<b>PACKAGING</b>	<i>bundles of 10 bars, standard length 6.000 mm</i>		
	<p>Alüminyum ekstrüzyon alt parça SL-55, SL-56 için (55 x10) <i>Aluminium extruded end slat appropriate to SL-55, SL-56 (55 x 10)</i></p>	<p>Pres <i>Mill finish</i> Beyaz <i>White</i> Gri <i>Gray</i> Kahve <i>Brown</i> Metalik Gri <i>Silver metallic</i> Krem <i>Ivory</i> Seçilen RAL <i>Selected RAL</i></p>	<p>ES.361.00.NAP ES.361.01.NAP ES.361.02.NAP ES.361.03.NAP ES.361.04.NAP ES.361.08.NAP ES.361.RA.NAP</p>	
	<b>AMBALAJ</b>	standart boylar 7.000, 7.500, 8.000 mm, 3 adetlik paketler halinde		
	<b>PACKAGING</b>	<i>bundles of 3 bars, standard lengths 7.000, 7.500, 8.000 mm</i>		



6

ÜRÜN İTEM	ÜRÜN ÖZELLİKLERİ PRODUCT DESCRIPTION	RENK COLOR	ÜRÜN KODU CODE	
	<p>Alüminyum ekstrüzyon alt parça SL-75, SL-77, ST-77, SE-77, SE-78, SE-80 için</p> <p><i>Aluminium extruded end slat for SL-75, SL-77, ST-77, SE-77, SE-78, SE-80</i></p>	<p>Pres <i>Mill finish</i> Beyaz <i>White</i> Gri <i>Grey</i> Kahve <i>Brown</i> Metalik gri <i>Silver metallic</i> Krem <i>Ivory</i> Seçilen RAL <i>Selected RAL</i></p>	<p>ES.425.00.GAP ES.425.01.GAP ES.425.02.GAP ES.425.03.GAP ES.425.04.GAP ES.425.08.GAP ES.425.RA.GAP</p>	
	<b>AMBALAJ</b>	standart boylar 4.000, 4.600, 5.200, 6.000, 6.500, 7.000 mm, 5 adetlik paketler halinde		
	<b>PACKAGING</b>	<i>bundles of 5 bars, standard lengths 4.000, 4.600, 5.200, 6.000, 6.500, 7.000 mm</i>		
	<p>Alüminyum ekstrüzyon alt parça SE-100, SE-101 için</p> <p><i>Aluminium extrusion end slat for SE-100, SE-101</i></p>	<p>Pres <i>Mill finish</i> Beyaz <i>White</i> Gri <i>Grey</i> Kahve <i>Brown</i> Metalik gri <i>Silver metallic</i> Krem <i>Ivory</i> Seçilen RAL <i>Selected RAL</i></p>	<p>ES.444.00.XAP ES.444.01.XAP ES.444.02.XAP ES.444.03.XAP ES.444.04.XAP ES.444.08.XAP ES.444.RA.XAP</p>	
	<b>AMBALAJ</b>	standart boylar 6.000, 7.000, 8.000 mm, 5 adetlik paketler halinde		
	<b>PACKAGING</b>	<i>bundles of 5 bars, standard lengths 6.000, 7.000, 8.000 mm</i>		
	<p>Alüminyum ekstrüzyon alt parça ST-100, SL-100, SL-101 için</p> <p><i>Aluminium extruded end slat for ST-100, SL-100, SL-101</i></p>	<p>Pres <i>Mill finish</i> Beyaz <i>White</i> Gri <i>Gray</i> Kahve <i>Brown</i> Metalik Gri <i>Silver metallic</i> Krem <i>Ivory</i> Seçilen RAL <i>Selected RAL</i></p>	<p>ES.133.00.XAP ES.133.01.XAP ES.133.02.XAP ES.133.03.XAP ES.133.04.XAP ES.133.08.XAP ES.133.RA.XAP</p>	
	<b>AMBALAJ</b>	standart boylar 6.000, 7.000, 8.000 mm, 5 adetlik paketler halinde		
	<b>PACKAGING</b>	<i>bundles of 5 bars, standard lengths 6.000, 7.000, 8.000 mm</i>		

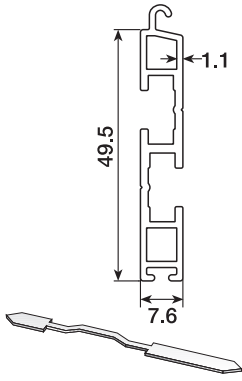
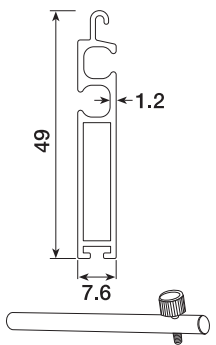
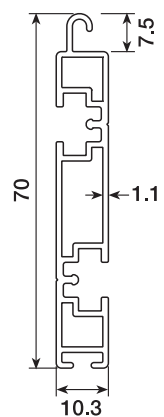
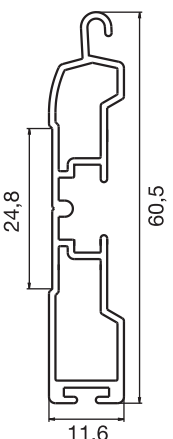

ÜRÜN İTEM	ÜRÜN ÖZELLİKLERİ PRODUCT DESCRIPTION	RENK COLOR	ÜRÜN KODU CODE
	<p>Alüminyum ekstrüzyon, kilit kanallı alt parça SL-39, SL-41, SL-45, SE-45 için</p> <p><i>Aluminium extruded end slat with lock channel for SL-39, SL-41, SL-45, SE-45</i></p>	<p>Pres <i>Mill finish</i> Beyaz <i>White</i> Gri <i>Grey</i> Kahve <i>Brown</i> Metalik gri <i>Silver metallic</i> Krem <i>Ivory</i> Seçilen RAL <i>Selected RAL</i></p>	<p>ES.441.00.KAP ES.441.01.KAP ES.441.02.KAP ES.441.03.KAP ES.441.04.KAP ES.441.08.KAP ES.441.RA.KAP</p>
	<b>AMBALAJ</b>	standart boy 6.000 mm, 10 adetlik paketler halinde	
	<b>PACKAGING</b>	<i>bundles of 10 bars, standard length 6.000 mm</i>	
	<p>Alüminyum ekstrüzyon, kilit kanallı alt parça SL-39, SL-41, SL-45, SE-45 için</p> <p><i>Aluminium extruded end slat with lock channel for SL-39, SL-41, SL-45, SE-45</i></p>	<p>Pres <i>Mill finish</i> Beyaz <i>White</i> Gri <i>Grey</i> Kahve <i>Brown</i> Metalik gri <i>Silver metallic</i> Krem <i>Ivory</i> Seçilen RAL <i>Selected RAL</i></p>	<p>ES.458.00.KAP ES.458.01.KAP ES.458.02.KAP ES.458.03.KAP ES.458.04.KAP ES.458.08.KAP ES.458.RA.KAP</p>
	<b>AMBALAJ</b>	standart boy 6.000 mm, 10 adetlik paketler halinde	
	<b>PACKAGING</b>	<i>bundles of 10 bars, standard length 6.000 mm</i>	
	<p>Alüminyum ekstrüzyon, kilit kanallı, alt parça SL-55, ST-56, SE-60, SE-62, SE-63 için</p> <p><i>Aluminium extruded, end slat, with lock channel for SL-55, ST-56, SE-60, SE-62, SE-63</i></p>	<p>Pres <i>Mill finish</i> Beyaz <i>White</i> Gri <i>Grey</i> Kahve <i>Brown</i> Metalik gri <i>Silver metallic</i> Krem <i>Ivory</i> Seçilen RAL <i>Selected RAL</i></p>	<p>ES.440.00.KAP ES.440.01.KAP ES.440.02.KAP ES.440.03.KAP ES.440.04.KAP ES.440.08.KAP ES.440.RA.KAP</p>
	<b>AMBALAJ</b>	standart boy 6.000 mm, 10 adetlik paketler halinde	
	<b>PACKAGING</b>	<i>bundles of 10 bars, standard length 6.000 mm</i>	
	<p>Özel alüminyum ekstrüzyon kilit kanallı alt parça SL-56 için (60,5 x 11,8)</p> <p><i>Customized aluminium extruded end slat with lock channel appropriate to SL-56 (60,5 x 11,8)</i></p>	PRES	ES.285.00.KAP
	<b>AMBALAJ</b>	standart boylar 3.500, 4.700, 5.200, 6.000 mm, 3 adetlik paketler halinde	
	<b>PACKAGING</b>	<i>bundles of 3 bars, standard lengths 3.500, 4.700, 5.200, 6.000 mm</i>	

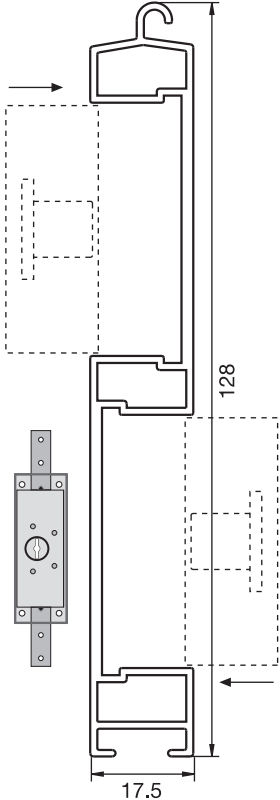
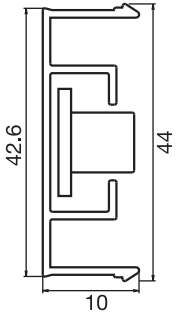
6

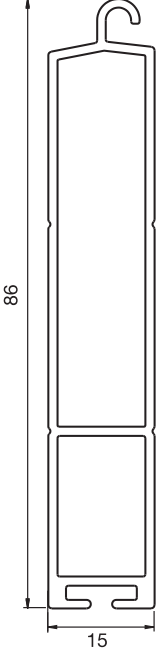
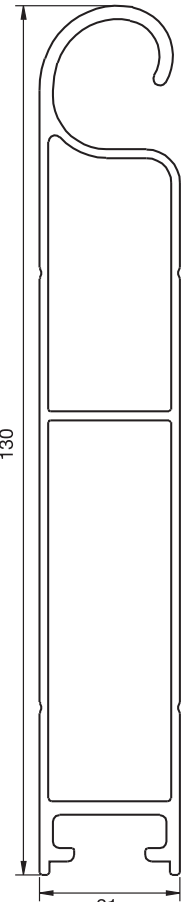
ÜRÜN İTEM	ÜRÜN ÖZELLİKLERİ PRODUCT DESCRIPTION	RENK COLOR	ÜRÜN KODU CODE
	<p>Alüminyum geniş alt parça merkez/yan kilitli (LO.375...) uyumlu SL-75, SL-77, SL-78, ST-77, SE-77, SE-78, uyumlu</p> <p><i>Aluminium end slat with central/side lock appropriate to (LO.375...) For SL-75, SL-77, SL-78, ST-77, SE-77, SE-78</i></p>	PRES	LO.379.00.KRM
	<b>AMBALAJ</b>	standart boylar 7.000 mm, 3 adetlik paketler halinde	
	<b>PACKAGING</b>	<i>bundles of 3 bars, standard lengths 7.000 mm</i>	
	<p>Alüminyum geniş alt parça-Kilit tamamlama profili (LO.379...) uyumlu <i>Aluminium end slat – lock finishing profile appropriate to(LO.379...)</i></p>	PRES	LO.375.00.CNY
	<b>AMBALAJ</b>	standart boylar 7.000 mm, 3 adetlik paketler halinde	
	<b>PACKAGING</b>	<i>bundles of 3 bars, standard lengths 7.000 mm</i>	

ÜRÜN İTEM	ÜRÜN ÖZELLİKLERİ PRODUCT DESCRIPTION	RENK COLOR	ÜRÜN KODU CODE	
	<p>Özel alüminyum ekstrüzyon alt parça SL-75, SL-77, ST-77, SE-77, SE-78 için (78,5 x 15-DE)</p> <p><i>Customized aluminium extruded end slat appropriate to SL-75, SL-77, ST-77, SE-77, SE-78 (78,5 x 15-DE)</i></p>	<p>Pres <i>Mill finish</i> Beyaz <i>White</i> Gri <i>Gray</i> Kahve <i>Brown</i> Metalik Gri <i>Silver metallic</i> Krem <i>Ivory</i> Seçilen RAL <i>Selected RAL</i></p>	<p>ES.367.00.GAP ES.367.01.GAP ES.367.02.GAP ES.367.03.GAP ES.367.04.GAP ES.367.08.GAP ES.367.RA.GAP</p>	
	<b>AMBALAJ</b>	standart boylar 3.500, 4.700, 5.200, 6.000 mm, 3 adetlik paketler halinde		
	<b>PACKAGING</b>	<i>bundles of 3 bars, standard lengths 3.500, 4.700, 5.200, 6.000 mm</i>		
	<p>SET-100 Galvaniz Profil için Alüminyum Alt Parça Profili (ES.410....) uyumlu</p> <p><i>Aluminium end slat for SET-100 galvanized profile appropriate to (ES.410....)</i></p>	PRES	ES.371.00.SET	
	<b>AMBALAJ</b>	standart boylar 7.000, 7.500, 8.000 mm, 3 adetlik paketler halinde		
	<b>PACKAGING</b>	<i>bundles of 3 bars, standard lengths 7.000, 7.500, 8.000 mm</i>		

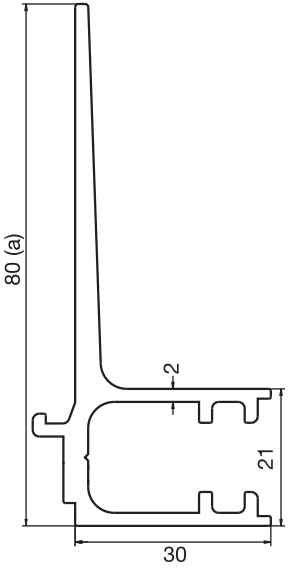
6

ÜRÜN İTEM	ÜRÜN ÖZELLİKLERİ PRODUCT DESCRIPTION	RENK COLOR	ÜRÜN KODU CODE
	<p>Galvaniz profil için alüminyum alt parça prf. (ES.409..., ES.371..., ES.133...) alt parça ile uyumlu</p> <p><i>Aluminium end slat for galvanized profile appropriate to (ES.409..., ES.371..., ES.133...)</i></p>	PRES	ES.410.00SET
	<p><b>AMBALAJ</b> standart boylar 7.000, 7.500 mm, 8.000 mm 3 adetlik paketler halinde</p> <p><b>PACKAGING</b> bundles of 3 bars, standard lengths 7.000, 7.500, 8.000 mm</p>		
	<p>Galvaniz profil için alüminyum köşebentli parça <i>Aluminium gusset for galvanized profile.</i></p>	PRES	ES.405.00.SET
	<p><b>AMBALAJ</b> standart boylar 7.000, 7.500 mm, 8.000 mm 3 adetlik paketler halinde</p> <p><b>PACKAGING</b> bundles of 3 bars, standard lengths 7.000, 7.500, 8.000 mm</p>		



ÜRÜN İTEM	ÜRÜN ÖZELLİKLERİ PRODUCT DESCRIPTION	RENK COLOR	ÜRÜN KODU CODE
	<p>Galvaniz profil için alüminyum alt parça prf. (ES.410...) alt parça ile uyumlu</p> <p><i>Aluminium end slat for galvanized profile appropriate to (ES.410...)</i></p>	PRES	ES.409.00.SET
	<b>AMBALAJ</b>	standart boylar 7.000, 7.500, 8.000 mm, 3 adetlik paketler halinde	
	<b>PACKAGING</b>	<i>bundles of 3 bars, standard lengths 7.000, 7.500, 8.000 mm</i>	
	<p>DAP serisi için kauçuk boru fitil ES-427...DAP, ES441...KAP, ES-458... KAP için</p> <p><i>Rubber hose insert for DAP series, for ES-427...DAP, ES441...KAP, ES-458... KAP</i></p>		ES.DAP.00.INS
	<b>AMBALAJ</b>	bir top 100 metre x 2 = 200 m. 1 koli	
	<b>PACKAGING</b>	<i>roll of 100 meters x 2 = 200 m. 1 package</i>	
	<p>NAP serisi için kauçuk boru fitil, ES-426...NAP, ES-440...KAP için</p> <p><i>Rubber hose insert for NAP series, for ES-426...NAP, ES-440...KAP</i></p>		ES.NAP.00.INS
	<b>AMBALAJ</b>	bir top 100 metre x 2 = 200 m. 1 koli	
	<b>PACKAGING</b>	<i>roll of 100 meters x 2 = 200 m. 1 package</i>	
	<p>GAP/XAP serileri için kauçuk boru fitil ES-425...GAP, ES-444...GAP için</p> <p><i>Rubber hose insert for GAP/XAP series for ES-425...GAP, ES-444...GAP</i></p>		ES.GAP.00.INS
	<b>AMBALAJ</b>	bir top 50 metre	
	<b>PACKAGING</b>	<i>roll of 50 meters</i>	
	<p>Alt Parça Lastik Fitili (SET.130.AP.DST için)</p> <p><i>End slat nylon stripe (for SET.130.AP.DST)</i></p>		ALF.000.00.000
	<b>AMBALAJ</b>	bir top 50 metre	
	<b>PACKAGING</b>	<i>roll of 50 meters</i>	
	<p>Silindir stopper</p> <p><i>Cylindrical stopper</i></p> <p>L=32mm D=25mm</p>	<p>Beyaz <i>White</i></p> <p>Kahve <i>Brown</i></p>	<p>SP.040.01.025</p> <p>SP.040.03.025</p>
	<b>AMBALAJ</b>	200 Adet	
	<b>PACKAGING</b>	200 Pieces	



**Rolforming Yöntemiyle Üretilmiş  
Alüminyum ve Galvaniz Kutular**

**Rollformed Aluminium and  
Galvanized Boxes**

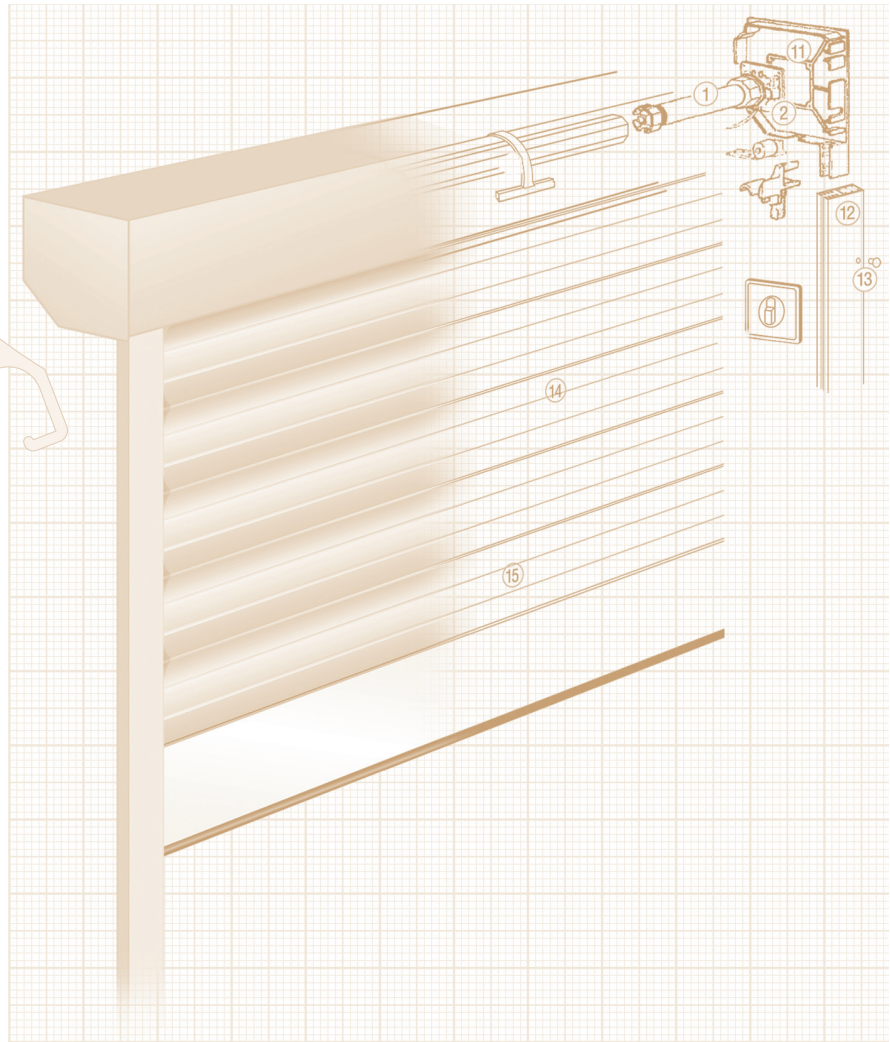

## ROLFORMİNG YÖNTEMİYLE ÜRETİLMİŞ ALÜMİNYUM KUTULAR

### ROLLFORMED ALUMINIUM BOXES

45°

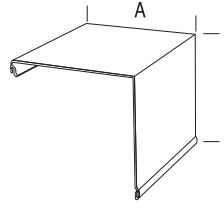
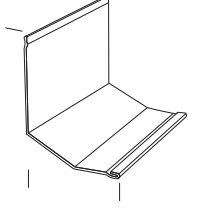
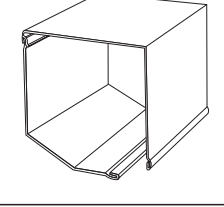
ÜRÜN İTEM	ÜRÜN ÖZELLİKLERİ PRODUCT DESCRIPTION	AMBALAJ PACKAGING	RENK COLOR	ÜRÜN KODU CODE
  	<p>A=137 mm üst A=137 mm top</p>	<p>5 adet 5 pieces</p>	<p>Beyaz <i>White</i> Gri <i>Grey</i> Kahve <i>Brown</i> Metalik gri <i>Silver metallic</i> Krem <i>Ivory</i> Açık bej <i>Light beige</i> Altın meşe <i>Golden oak</i> Fındık ahşap <i>Nussbaum</i></p>	<p>SK.137.01.T90 SK.137.02.T90 SK.137.03.T90 SK.137.04.T90 SK.137.08.T90 SK.137.11.T90 SK.137.17.T90 SK.137.22.T90</p>
	<p>A=137 mm 45° ön A=137 mm front 45°</p> <p>Standart boy 6.000, 6.500, 7.000, 7.500, 8.000 mm Standard lenght 6.000, 6.500, 7.000, 7.500, 8.000 mm</p>	<p>5 adet 5 pieces</p>	<p>Beyaz <i>White</i> Gri <i>Grey</i> Kahve <i>Brown</i> Metalik gri <i>Silver metallic</i> krem <i>Ivory</i> Açık bej <i>Light beige</i> Altın meşe <i>Golden oak</i> Fındık ahşap <i>Nussbaum</i></p>	<p>SK.137.01.F45 SK.137.02.F45 SK.137.03.F45 SK.137.04.F45 SK.137.08.F45 SK.137.11.F45 SK.137.17.F45 SK.137.22.F45</p>

7

ÜRÜN İTEM	ÜRÜN ÖZELLİKLERİ PRODUCT DESCRIPTION	AMBALAJ PACKAGING	RENK COLOR	ÜRÜN KODU CODE
  	<p>A=150 mm üst A=150 mm top</p>	<p>5 adet 5 pieces</p>	<p>Beyaz <i>White</i> Gri <i>Grey</i> Kahve <i>Brown</i> Metalik gri <i>Silver metallic</i> Krem <i>Ivory</i></p>	<p>SK.150.01.T90 SK.150.02.T90 SK.150.03.T90 SK.150.04.T90 SK.150.08.T90</p>
	<p>A=150 mm ön 45° A=150 mm front 45°</p> <p>Standart boy 6.000, 6.500, 7.000, 7.500, 8.000 mm Standard lenght 6.000, 6.500, 7.000, 7.500, 8.000 mm</p>	<p>5 adet 5 pieces</p>	<p>Beyaz <i>White</i> Gri <i>Grey</i> Kahve <i>Brown</i> Metalik gri <i>Silver metallic</i> krem <i>Ivory</i></p>	<p>SK.150.01.F45 SK.150.02.F45 SK.150.03.F45 SK.150.04.F45 SK.150.08.F45</p>

Özel siparişlerde 10,50 m'ye kadar tek parça üretilir.

In order to special project, consisting of one piece 10,5 meter can be produced

## ROLFORMING YÖNTEMİYLE ÜRETİLMİŞ ALÜMİNYUM KUTULAR ROLLFORMED ALUMINIUM BOXES

45°

7

ÜRÜN İTEM	ÜRÜN ÖZELLİKLERİ PRODUCT DESCRIPTION	AMBALAJ PACKAGING	RENK COLOR	ÜRÜN KODU CODE
	<p>A=165 mm üst A=165 mm top</p>	<p>5 adet 5 pieces</p>	<p>Beyaz <i>White</i> Gri <i>Grey</i> Kahve <i>Brown</i> Metalik gri <i>Silver metallic</i> Krem <i>Ivory</i> Açık bej <i>Light beige</i> Altın meşe <i>Golden oak</i> Fındık ahşap <i>Nussbaum</i> Ceviz <i>Walnut wood</i></p>	<p>SK.165.01.T90 SK.165.02.T90 SK.165.03.T90 SK.165.04.T90 SK.165.08.T90 SK.165.11.T90 SK.165.17.T90 SK.165.22.T90 SK.165.25.T90</p>
	<p>A=165 mm ön 45° A=165 mm front 45°</p> <p>Standart boy 6.000, 6.500, 7.000, 7.500, 8.000 mm Standard lenght 6.000, 6.500, 7.000, 7.500, 8.000 mm</p>	<p>5 adet 5 pieces</p>	<p>Beyaz <i>White</i> Gri <i>Grey</i> Kahve <i>Brown</i> Metalik gri <i>Silver metallic</i> Krem <i>Ivory</i> Açık bej <i>Light beige</i> Altın meşe <i>Golden oak</i> Fındık ahşap <i>Nussbaum</i> Ceviz <i>Walnut wood</i></p>	<p>SK.165.01.F45 SK.165.02.F45 SK.165.03.F45 SK.165.04.F45 SK.165.08.F45 SK.165.11.F45 SK.165.17.F45 SK.165.22.F45 SK.165.25.F45</p>

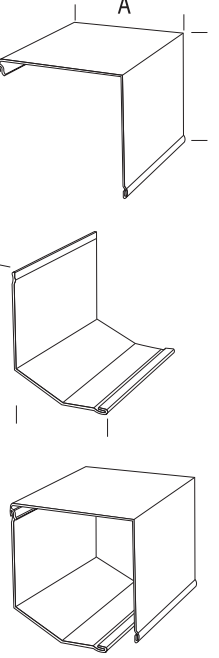
ÜRÜN İTEM	ÜRÜN ÖZELLİKLERİ PRODUCT DESCRIPTION	AMBALAJ PACKAGING	RENK COLOR	ÜRÜN KODU CODE
	<p>A=180 mm üst A=180 mm top</p>	<p>5 adet 5 pieces</p>	<p>Beyaz <i>White</i> Gri <i>Grey</i> Kahve <i>Brown</i> Metalik gri <i>Silver metallic</i> Krem <i>Ivory</i> Açık bej <i>Light beige</i> Altın meşe <i>Golden oak</i></p>	<p>SK.180.01.T90 SK.180.02.T90 SK.180.03.T90 SK.180.04.T90 SK.180.08.T90 SK.180.11.T90 SK.180.17.T90</p>
	<p>A=180 mm ön 45° A=180 mm front 45°</p> <p>Standart boy 6.000, 6.500, 7.000, 7.500, 8.000 mm Standard lenght 6.000, 6.500, 7.000, 7.500, 8.000 mm</p>	<p>5 adet 5 pieces</p>	<p>Beyaz <i>White</i> Gri <i>Grey</i> Kahve <i>Brown</i> Metalik gri <i>Silver metallic</i> Krem <i>Ivory</i> Açık bej <i>Light beige</i> Altın meşe <i>Golden oak</i></p>	<p>SK.180.01.F45 SK.180.02.F45 SK.180.03.F45 SK.180.04.F45 SK.180.08.F45 SK.180.11.F45 SK.180.17.F45</p>

## ROLFORMİNG YÖNTEMİYLE ÜRETİLMİŞ ALÜMİNYUM KUTULAR

### ROLLFORMED ALUMINIUM BOXES

45°

ÜRÜN İTEM	ÜRÜN ÖZELLİKLERİ PRODUCT DESCRIPTION	AMBALAJ PACKAGING	RENK COLOR	ÜRÜN KODU CODE
	<p>A=205 mm üst A=205 mm top</p>	<p>5 adet 5 pieces</p>	<p>Beyaz <i>White</i> Gri <i>Grey</i> Kahve <i>Brown</i> Metalik gri <i>Silver metallic</i> Krem <i>Ivory</i> Altın meşe <i>Golden oak</i> Fındık ahşap <i>Nussbaum</i> Ceviz <i>Walnut wood</i></p>	<p>SK.205.01.T90 SK.205.02.T90 SK.205.03.T90 SK.205.04.T90 SK.205.08.T90 SK.205.17.T90 SK.205.22.T90 SK.205.25.T90</p>
	<p>A=205 mm ön 45° A=205 mm front 45°</p> <p>Standart boy 6.000, 6.500, 7.000, 7.500, 8.000 mm Standard lenght 6.000, 6.500, 7.000, 7.500, 8.000 mm</p>	<p>5 adet 5 pieces</p>	<p>Beyaz <i>White</i> Gri <i>Grey</i> Kahve <i>Brown</i> Metalik gri <i>Silver metallic</i> Krem <i>Ivory</i> Altın meşe <i>Golden oak</i> Fındık ahşap <i>Nussbaum</i> Ceviz <i>Walnut wood</i></p>	<p>SK.205.01.F45 SK.205.02.F45 SK.205.03.F45 SK.205.04.F45 SK.205.08.F45 SK.205.17.F45 SK.205.22.F45 SK.205.25.F45</p>

7

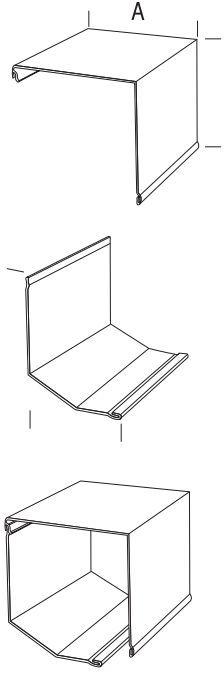
ÜRÜN İTEM	ÜRÜN ÖZELLİKLERİ PRODUCT DESCRIPTION	AMBALAJ PACKAGING	RENK COLOR	ÜRÜN KODU CODE
	<p>A=250 mm üst A=250 mm top</p>	<p>5 adet 5 pieces</p>	<p>Beyaz <i>White</i> Gri <i>Grey</i> Kahve <i>Brown</i> Metalik gri <i>Silver metallic</i> Krem <i>Ivory</i></p>	<p>SK.250.01.T90 SK.250.02.T90 SK.250.03.T90 SK.250.04.T90 SK.250.08.T90</p>
	<p>A=250 mm 45° ön A=250 mm front 45°</p> <p>Standart boy 6.000, 6.500, 7.000, 7.500, 8.000 mm Standard lenght 6.000, 6.500, 7.000, 7.500, 8.000 mm</p>	<p>5 adet 5 pieces</p>	<p>Beyaz <i>White</i> Gri <i>Grey</i> Kahve <i>Brown</i> Metalik gri <i>Silver metallic</i> krem <i>Ivory</i></p>	<p>SK.250.01.F45 SK.250.02.F45 SK.250.03.F45 SK.250.04.F45 SK.250.08.F45</p>



## ROLFORMİNG YÖNTEMİYLE ÜRETİLMİŞ ALÜMİNYUM KUTULAR ROLLFORMED ALUMINIUM BOXES

45°

7

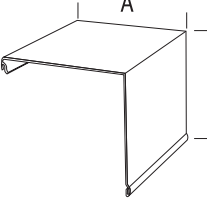
ÜRÜN İTEM	ÜRÜN ÖZELLİKLERİ PRODUCT DESCRIPTION	AMBALAJ PACKAGING	RENK COLOR	ÜRÜN KODU CODE
	<p>A=300 mm üst A=300 mm top</p>	<p>3 adet 3 pieces</p>	<p>Beyaz <i>White</i> Gri <i>Grey</i> Kahve <i>Brown</i> Metalik gri <i>Silver metallic</i> Krem <i>Ivory</i> Altın meşe <i>Golden oak</i></p>	<p>SK.300.01.T90 SK.300.02.T90 SK.300.03.T90 SK.300.04.T90 SK.300.08.T90 SK.300.17.T90</p>
	<p>A=300 mm ön 45° A=300 mm front 45°</p> <p>Standart boy 6.000, 6.500, 7.000, 7.500, 8.000 mm Standard lenght 6.000, 6.500, 7.000, 7.500, 8.000 mm</p>	<p>3 adet 3 pieces</p>	<p>Beyaz <i>White</i> Gri <i>Grey</i> Kahve <i>Brown</i> Metalik gri <i>Silver metallic</i> Krem <i>Ivory</i> Altın meşe <i>Golden oak</i></p>	<p>SK.300.01.F45 SK.300.02.F45 SK.300.03.F45 SK.300.04.F45 SK.300.08.F45 SK.300.17.F45</p>

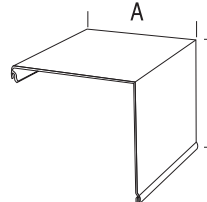
ÜRÜN İTEM	ÜRÜN ÖZELLİKLERİ PRODUCT DESCRIPTION	AMBALAJ PACKAGING	RENK COLOR	ÜRÜN KODU CODE
	<p>A=330 mm üst A=330 mm top</p>	<p>3 adet 3 pieces</p>	<p>Beyaz <i>White</i> Gri <i>Grey</i> Kahve <i>Brown</i> Metalik gri <i>Silver metallic</i> Krem <i>Ivory</i></p>	<p>SK.330.01.T90 SK.330.02.T90 SK.330.03.T90 SK.330.04.T90 SK.330.08.T90</p>
	<p>A=330 mm üst 45° A=330 mm top 45°</p> <p>Standart boy 6.000, 6.500, 7.000, 7.500, 8.000 mm Standard lenght 6.000, 6.500, 7.000, 7.500, 8.000 mm</p>	<p>3 adet 3 pieces</p>	<p>Beyaz <i>White</i> Gri <i>Grey</i> Kahve <i>Brown</i> Metalik gri <i>Silver metallic</i> Krem <i>Ivory</i></p>	<p>SK.330.01.F45 SK.330.02.F45 SK.330.03.F45 SK.330.04.F45 SK.330.08.F45</p>

## ROLFORMİNG YÖNTEMİYLE ÜRETİLMİŞ ALÜMİNYUM KUTULAR ROLLFORMED ALUMINIUM BOXES

45°

ÜRÜN İTEM	ÜRÜN ÖZELLİKLERİ PRODUCT DESCRIPTION	AMBALAJ PACKAGING	RENK COLOR	ÜRÜN KODU CODE
	A=350 mm üst A=350 mm top	3 adet 3 pieces	Beyaz <i>White</i> Gri <i>Grey</i> Kahve <i>Brown</i> Metalik gri <i>Silver metallic</i> Krem <i>Ivory</i> Açık bej <i>Light beige</i> Altın meşe <i>Golden oak</i>	SK.350.01.T90 SK.350.02.T90 SK.350.03.T90 SK.350.04.T90 SK.350.08.T90 SK.350.11.T90 SK.350.17.F45
	A=350 mm ön 45° A=350 mm front 45°	3 adet 3 pieces	Beyaz <i>White</i> Gri <i>Grey</i> Kahve <i>Brown</i> Metalik gri <i>Silver metallic</i> krem <i>Ivory</i> Açık bej <i>Light beige</i> Altın meşe <i>Golden oak</i>	SK.350.01.F45 SK.350.02.F45 SK.350.03.F45 SK.350.04.F45 SK.350.08.F45 SK.350.11.F45 SK.350.17.F45
	Standart boy 6.000, 6.500, 7.000, 7.500, 8.000 mm Standard lenght 6.000, 6.500, 7.000, 7.500, 8.000 mm			

7

45°

ÜRÜN İTEM	ÜRÜN ÖZELLİKLERİ PRODUCT DESCRIPTION	AMBALAJ PACKAGING	RENK COLOR	ÜRÜN KODU CODE
	A=400 mm üst A=400 mm top	3 adet 3 pieces	Beyaz <i>White</i> Gri <i>Grey</i> Kahve <i>Brown</i> Metalik gri <i>Silver metallic</i> Krem <i>Ivory</i>	SK.400.01.T90 SK.400.02.T90 SK.400.03.T90 SK.400.04.T90 SK.400.08.T90
	A=400 mm arka A=400 mm back	3 adet 3 pieces	Beyaz <i>White</i> Gri <i>Grey</i> Kahve <i>Brown</i> Metalik gri <i>Silver metallic</i> krem <i>Ivory</i>	SK.400.01.B90 SK.400.02.B90 SK.400.03.B90 SK.400.04.B90 SK.400.08.B90
	A=400 mm ön 45° A=400 mm front 45°	3 adet 3 pieces	Beyaz <i>White</i> Gri <i>Grey</i> Kahve <i>Brown</i> Metalik gri <i>Silver metallic</i> krem <i>Ivory</i>	SK.400.01.F45 SK.400.02.F45 SK.400.03.F45 SK.400.04.F45 SK.400.08.F45
	Standart boy 6.000, 6.500, 7.000, 7.500, 8.000 mm Standard lenght 6.000, 6.500, 7.000, 7.500, 8.000 mm			

## ROLFORMİNG YÖNTEMİYLE ÜRETİLMİŞ ALÜMİNYUM KUTULAR ROLLFORMED ALUMINIUM BOXES

90°

7

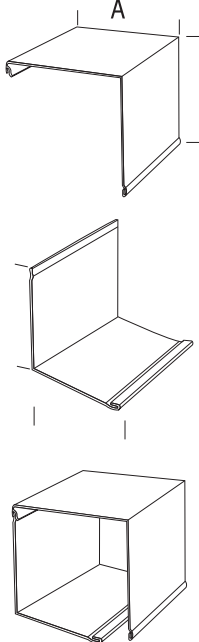
ÜRÜN İTEM	ÜRÜN ÖZELLİKLERİ PRODUCT DESCRIPTION	AMBALAJ PACKAGING	RENK COLOR	ÜRÜN KODU CODE
	<p>A=165 mm üst A=165 mm top</p>	<p>5 adet 5 pieces</p>	<p>Beyaz <i>White</i> Gri <i>Grey</i> Kahve <i>Brown</i> Metalik gri <i>Silver metallic</i> Krem <i>Ivory</i></p>	<p>SK.165.01.T90 SK.165.02.T90 SK.165.03.T90 SK.165.04.T90 SK.165.08.T90</p>
	<p>A=165 mm ön 90° A=165 mm front 90°</p> <p>Standart boy 6.000, 6.500, 7.000, 7.500, 8.000 mm Standard lenght 6.000, 6.500, 7.000, 7.500, 8.000 mm</p>	<p>5 adet 5 pieces</p>	<p>Beyaz <i>White</i> Gri <i>Grey</i> Kahve <i>Brown</i> Metalik gri <i>Silver metallic</i> krem <i>Ivory</i></p>	<p>SK.165.01.F90 SK.165.02.F90 SK.165.03.F90 SK.165.04.F90 SK.165.08.F90</p>

90°

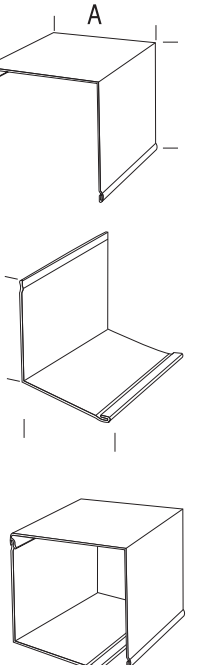
ÜRÜN İTEM	ÜRÜN ÖZELLİKLERİ PRODUCT DESCRIPTION	AMBALAJ PACKAGING	RENK COLOR	ÜRÜN KODU CODE
	<p>A=180 mm üst A=180 mm top</p>	<p>5 adet 5 pieces</p>	<p>Beyaz <i>White</i> Gri <i>Grey</i> Kahve <i>Brown</i> Metalik gri <i>Silver metallic</i> Krem <i>Ivory</i></p>	<p>SK.180.01.T90 SK.180.02.T90 SK.180.03.T90 SK.180.04.T90 SK.180.08.T90</p>
	<p>A=180 mm ön 90° A=180 mm front 90°</p> <p>Standart boy 6.000, 6.500, 7.000, 7.500, 8.000 mm Standard lenght 6.000, 6.500, 7.000, 7.500, 8.000 mm</p>	<p>5 adet 5 pieces</p>	<p>Beyaz <i>White</i> Gri <i>Grey</i> Kahve <i>Brown</i> Metalik gri <i>Silver metallic</i> krem <i>Ivory</i></p>	<p>SK.180.01.F90 SK.180.02.F90 SK.180.03.F90 SK.180.04.F90 SK.180.08.F90</p>

## ROLFORMING YÖNTEMIYLE ÜRETİLMİŞ ALÜMİNYUM KUTULAR ROLLFORMED ALUMINIUM BOXES

90°

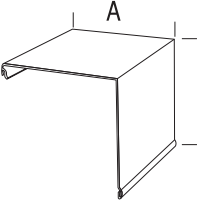
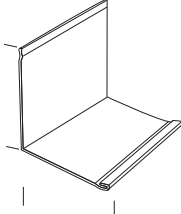
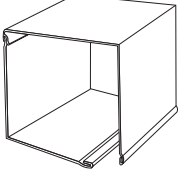
ÜRÜN ITEM	ÜRÜN ÖZELLİKLERİ PRODUCT DESCRIPTION	AMBALAJ PACKAGING	RENK COLOR	ÜRÜN KODU CODE
	A=205 mm üst A=205 mm top	5 adet 5 pieces	Beyaz <i>White</i> Gri <i>Grey</i> Kahve <i>Brown</i> Metalik gri <i>Silver metallic</i> Krem <i>Ivory</i>	SK.205.01.T90 SK.205.02.T90 SK.205.03.T90 SK.205.04.T90 SK.205.08.T90
	A=205 mm ön 90° A=205 mm front 90°	5 adet 5 pieces	Beyaz <i>White</i> Gri <i>Grey</i> Kahve <i>Brown</i> Metalik gri <i>Silver metallic</i> Krem <i>Ivory</i>	SK.205.01.F90 SK.205.02.F90 SK.205.03.F90 SK.205.04.F90 SK.205.08.F90
	Standart boy 6.000, 6.500, 7.000, 7.500, 8.000 mm Standard lenght 6.000, 6.500, 7.000, 7.500, 8.000 mm			

7

## ROLFORMİNG YÖNTEMİYLE ÜRETİLMİŞ ÖN YÜZÜ YUVARLAK KUTULAR THE FRONT OF ROUND BOXES PRODUCED BY ROLLFORMING METHOD

7

ÜRÜN İTEM	ÜRÜN ÖZELLİKLERİ PRODUCT DESCRIPTION	AMBALAJ PACKAGING	RENK COLOR	ÜRÜN KODU CODE
	A=137 mm rolform üst A=137 mm rollformed top	5 adet 5 pieces	Beyaz <i>White</i> Kahve <i>Brown</i> Metalik gri <i>Silver metallic</i>	SK.137.01.TRO SK.137.03.TRO SK.137.04.TRO
	A=137 mm ekstrüzyon yuvarlak ön yüz A=137 mm extruded round front	5 adet 5 pieces	Beyaz <i>White</i> Kahve <i>Brown</i> Metalik gri <i>Silver metallic</i>	SK.137.01.FRO SK.137.03.FRO SK.137.04.FRO
	Standart boy 6.000 mm Standard lenght 6.000 mm			

ÜRÜN İTEM	ÜRÜN ÖZELLİKLERİ PRODUCT DESCRIPTION	AMBALAJ PACKAGING	RENK COLOR	ÜRÜN KODU CODE
	A=165 mm rolform üst A=165 mm rollformed top	5 adet 5 pieces	Beyaz <i>White</i> Kahve <i>Brown</i> Metalik gri <i>Silver metallic</i>	SK.165.01.TRO SK.165.03.TRO SK.165.04.TRO
	A=165 mm ekstrüzyon yuvarlak ön yüz A=165 mm extruded round front	5 adet 5 pieces	Beyaz <i>White</i> Kahve <i>Brown</i> Metalik gri <i>Silver metallic</i>	SK.165.01.FRO SK.165.03.FRO SK.165.04.FRO
	Standart boy 6.000 mm Standard lenght 6.000 mm			

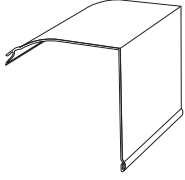
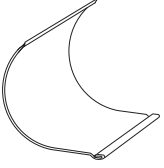
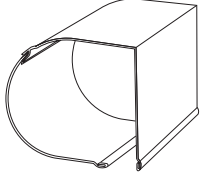

**ROLFORMİNG YÖNTEMİYLE ÜRETİLMİŞ ÖN YÜZÜ YUVARLAK KUTULAR**  
**THE FRONT OF ROUND BOXES PRODUCED BY ROLLFORMING METHOD**

ÜRÜN ITEM	ÜRÜN ÖZELLİKLERİ PRODUCT DESCRIPTION	AMBALAJ PACKAGING	RENK COLOR	ÜRÜN KODU CODE
	A=205 mm rolform üst <i>A=205 mm rollformed top</i>	5 adet <i>5 pieces</i>	Beyaz <i>White</i> Kahve <i>Brown</i> Metalik gri <i>Silver metallic</i>	SK.205.01.TRO SK.205.03.TRO SK.205.04.TRO
	A=205 mm ekstrüzyon yuvarlak ön yüz <i>A=205 mm extruded round front</i>	5 adet <i>5 pieces</i>	Beyaz <i>White</i> Kahve <i>Brown</i> Metalik gri <i>Silver metallic</i>	SK.205.01.FRO SK.205.03.FRO SK.205.04.FRO
	Standart boy 6.000 mm <i>Standard lenght 6.000 mm</i>			

7

## ROLFORMİNG YÖNTEMİYLE ÜRETİLMİŞ GALVANİZ KUTULAR

### ROLLFORMED GALVANISED BOXES

45°

7

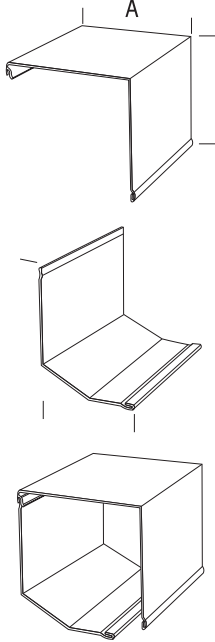
ÜRÜN İTEM	ÜRÜN ÖZELLİKLERİ PRODUCT DESCRIPTION	AMBALAJ PACKAGING	RENK COLOR	ÜRÜN KODU CODE
	<p>A=300 mm üst A=300 mm top</p>	<p>3 adet 3 pieces</p>	<p>Beyaz <i>White</i> Kahve <i>Brown</i> Metalik gri <i>Silver metallic</i> Krem <i>Ivory</i></p>	<p>GK.300.01.T90 GK.300.03.T90 GK.300.04.T90 GK.300.08.T90</p>
	<p>A=300 mm ön 45° A=300 mm front 45°</p> <p>Standart boy 6.000, 6.500, 7.000, 7.500, 8.000 mm Standard lenght 6.000, 6.500, 7.000, 7.500, 8.000 mm</p>	<p>3 adet 3 pieces</p>	<p>Beyaz <i>White</i> Kahve <i>Brown</i> Metalik gri <i>Silver metallic</i> Krem <i>Ivory</i></p>	<p>GK.300.01.F45 GK.300.03.F45 GK.300.04.F45 GK.300.08.F45</p>

45°

ÜRÜN İTEM	ÜRÜN ÖZELLİKLERİ PRODUCT DESCRIPTION	AMBALAJ PACKAGING	RENK COLOR	ÜRÜN KODU CODE
	<p>A=330 mm üst A=330 mm top</p>	<p>3 adet 3 pieces</p>	<p>Beyaz <i>White</i> Kahve <i>Brown</i> Metalik gri <i>Silver metallic</i> Krem <i>Ivory</i></p>	<p>GK.330.01.T90 GK.330.03.T90 GK.330.04.T90 GK.330.08.T90</p>
	<p>A=330 mm üst 45° A=330 mm top 45°</p> <p>Standart boy 6.000, 6.500, 7.000, 7.500, 8.000 mm Standard lenght 6.000, 6.500, 7.000, 7.500, 8.000 mm</p>	<p>3 adet 3 pieces</p>	<p>Beyaz <i>White</i> Kahve <i>Brown</i> Metalik gri <i>Silver metallic</i> Krem <i>Ivory</i></p>	<p>GK.330.01.F45 GK.330.03.F45 GK.330.04.F45 GK.330.08.F45</p>

## ROLFORMİNG YÖNTEMİYLE ÜRETİLMİŞ GALVANİZ KUTULAR

### ROLLFORMED GALVANISED BOXES

45°

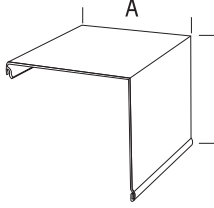
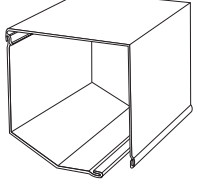
ÜRÜN İTEM	ÜRÜN ÖZELLİKLERİ PRODUCT DESCRIPTION	AMBALAJ PACKAGING	RENK COLOR	ÜRÜN KODU CODE
  	<p>A=350 mm üst A=350 mm top</p>	<p>3 adet 3 pieces</p>	<p>Beyaz <i>White</i> Kahve <i>Brown</i> Metalik gri <i>Silver metallic</i> Krem <i>Ivory</i></p>	<p>GK.350.01.T90 GK.350.03.T90 GK.350.04.T90 GK.350.08.T90</p>
	<p>A=350 mm üst 45° A=350 mm top 45°</p>	<p>3 adet 3 pieces</p>	<p>Beyaz <i>White</i> Kahve <i>Brown</i> Metalik gri <i>Silver metallic</i> Krem <i>Ivory</i></p>	<p>GK.350.01.F45 GK.350.03.F45 GK.350.04.F45 GK.350.08.F45</p>
	<p>Standart boy 6.000, 6.500, 7.000, 7.500, 8.000 mm Standard lenght 6.000, 6.500, 7.000, 7.500, 8.000 mm</p>			

7

45°

ÜRÜN İTEM	ÜRÜN ÖZELLİKLERİ PRODUCT DESCRIPTION	AMBALAJ PACKAGING	RENK COLOR	ÜRÜN KODU CODE
  	<p>A=400 mm üst A=400 mm top</p>	<p>3 adet 3 pieces</p>	<p>Beyaz <i>White</i> Kahve <i>Brown</i> Metalik gri <i>Silver metallic</i> Krem <i>Ivory</i></p>	<p>GK.400.01.T90 GK.400.03.T90 GK.400.04.T90 GK.400.08.T90</p>
	<p>A=400 mm üst 45° A=400 mm top 45°</p>	<p>3 adet 3 pieces</p>	<p>Beyaz <i>White</i> Kahve <i>Brown</i> Metalik gri <i>Silver metallic</i> Krem <i>Ivory</i></p>	<p>GK.400.01.F45 GK.400.03.F45 GK.400.04.F45 GK.400.08.F45</p>
	<p>Standart boy 6.000, 6.500, 7.000, 7.500, 8.000 mm Standard lenght 6.000, 6.500, 7.000, 7.500, 8.000 mm</p>			

## ROLFORMİNG YÖNTEMİYLE ÜRETİLMİŞ GALVANİZ KUTULAR ROLLFORMED GALVANISED BOXES

45°

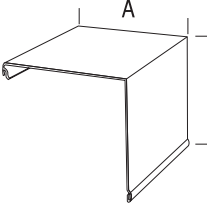
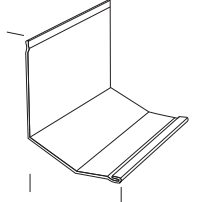
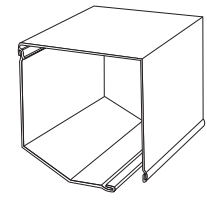
ÜRÜN İTEM	ÜRÜN ÖZELLİKLERİ PRODUCT DESCRIPTION	AMBALAJ PACKAGING	RENK COLOR	ÜRÜN KODU CODE
  	A=440 mm üst A=440 mm top	3 adet 3 pieces	Beyaz <i>White</i> Kahve <i>Brown</i> Metalik gri <i>Silver metallic</i> Krem <i>Ivory</i>	GK.440.01.T90 GK.440.03.T90 GK.440.04.T90 GK.440.08.T90
	A=440 mm üst 45° A=440 mm top 45°  Standart boy 6.000, 6.500, 7.000, 7.500, 8.000 mm Standard lenght 6.000, 6.500, 7.000, 7.500, 8.000 mm	3 adet 3 pieces	Beyaz <i>White</i> Kahve <i>Brown</i> Metalik gri <i>Silver metallic</i> Krem <i>Ivory</i>	GK.440.01.F45 GK.440.03.F45 GK.440.04.F45 GK.440.08.F45

## Yan Kapaklar

### *Side Frames*

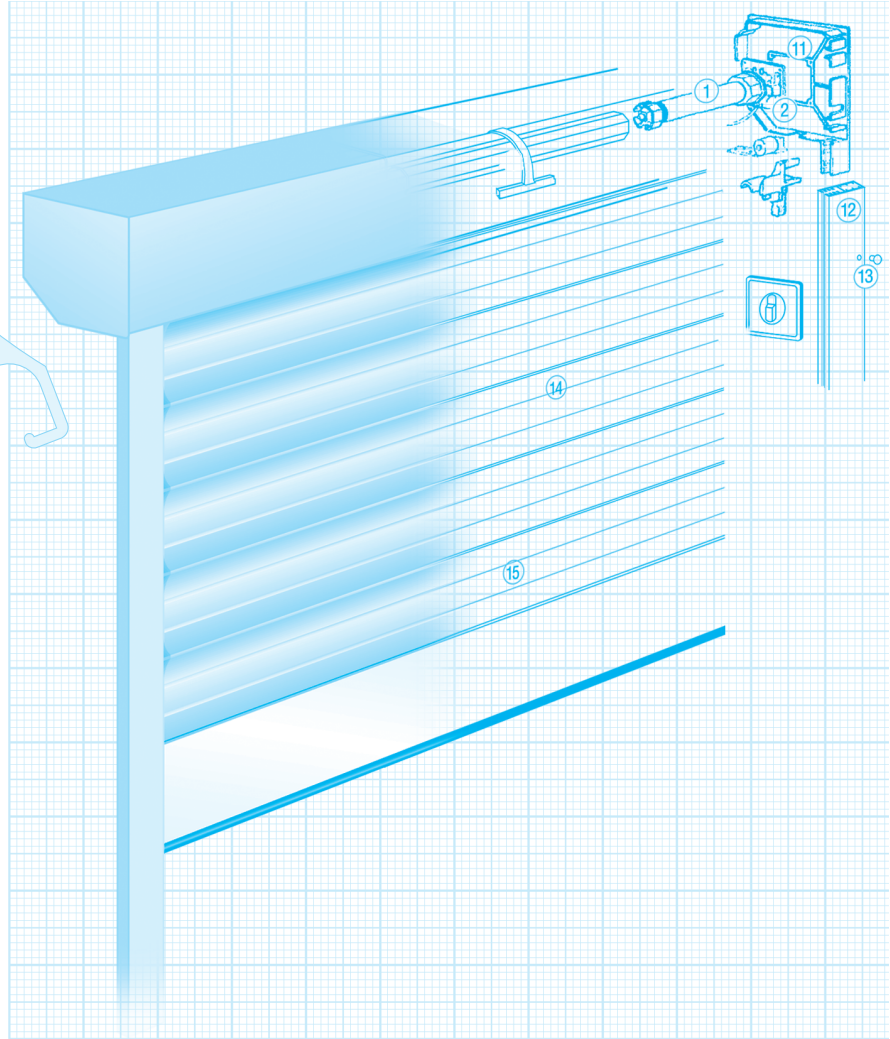
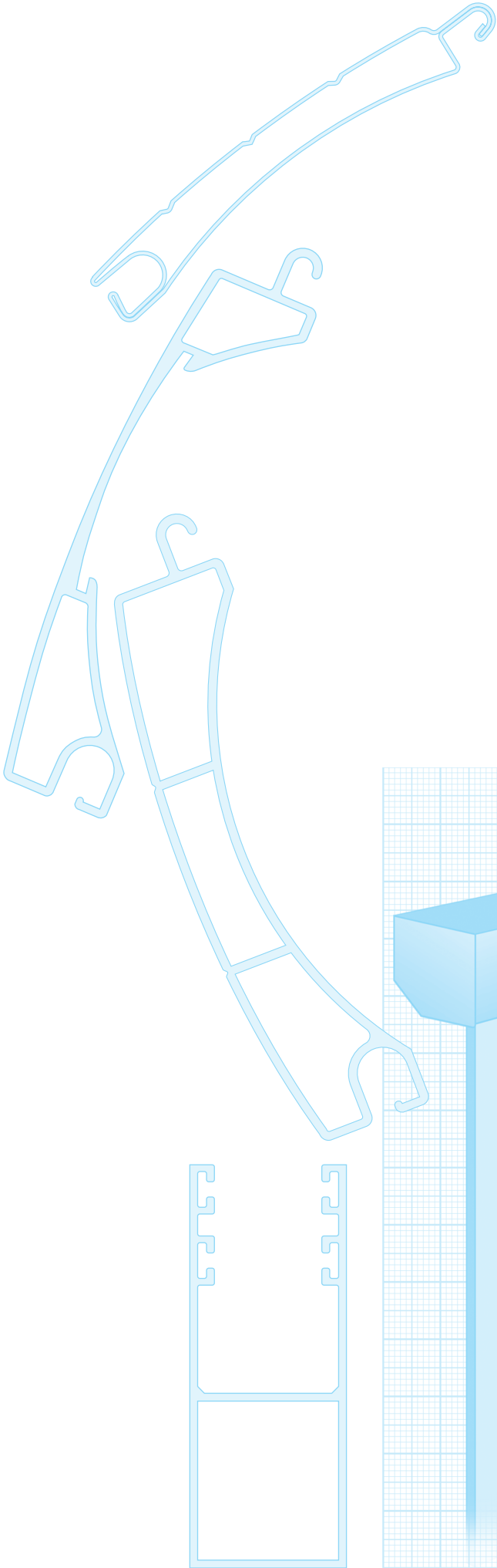

- 1
- 2
- 3
- 4
- 5
- 6
- 7
- 8
- 9
- 10
- 11
- 12
- 13
- 14
- 15
- 16
- 17
- 18
- 19
- 20
- 21
- 22
- 23
- 24
- 25
- 26
- 27
- 28
- 29

## YAN KAPAKLAR SIDE FRAMES

45°

8

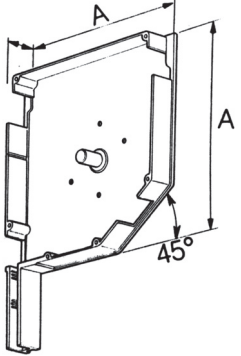
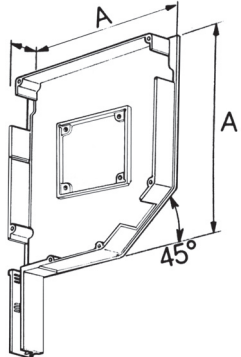
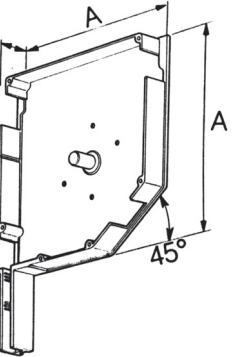
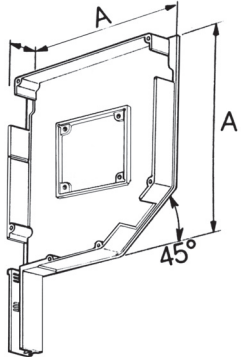
ÜRÜN İTEM	ÜRÜN ÖZELLİKLERİ PRODUCT DESCRIPTION	AMBALAJ PACKAGING	RENK COLOR	ÜRÜN KODU CODE
	<p><b>137 mm Yan Kapaklar</b> <b>137 mm Side Frames</b></p> <p>45° 137 mm pres döküm pimli yan kapak 45° <i>137 mm shutter frame in die cast aluminium with pivot</i></p>	<p>40 Çift <i>40 Pair</i></p>	<p>Pres <i>Mill finish</i> Beyaz <i>White</i> Gri <i>Grey</i> Kahve <i>Brown</i> Metalik gri <i>Silver metallic</i> Krem <i>Ivory</i> Seçilen RAL <i>Selected RAL</i></p>	<p>SF.137.00.045 SF.137.01.045 SF.137.02.045 SF.137.03.045 SF.137.04.045 SF.137.08.045 SF.137.RA.045</p>
	<p>45° 137 mm pres döküm plaketli yan kapak 45° <i>137 mm shutter frame in die cast aluminium with fixing plate housing</i></p>	<p>40 Çift <i>40 Pair</i></p>	<p>Pres <i>Mill finish</i> Beyaz <i>White</i> Gri <i>Grey</i> Kahve <i>Brown</i> Metalik gri <i>Silver metallic</i> Krem <i>Ivory</i> Seçilen RAL <i>Selected RAL</i></p>	<p>SF.137.00.B45 SF.137.01.B45 SF.137.02.B45 SF.137.03.B45 SF.137.04.B45 SF.137.08.B45 SF.137.RA.B45</p>
	<p><b>150 mm Yan Kapaklar</b> <b>150 mm Side Frames</b></p> <p>45° 150 mm Pres döküm pimli yan kapak 45° <i>150 mm Shutter frame in die cast aluminium with pivot</i></p>	<p>30 Çift <i>30 Pair</i></p>	<p>Pres <i>Mill finish</i> Beyaz <i>White</i> Gri <i>Grey</i> Kahve <i>Brown</i> Metalik gri <i>Silver metallic</i> Krem <i>Ivory</i> Seçilen RAL <i>Selected RAL</i></p>	<p>SF.150.00.045 SF.150.01.045 SF.150.02.045 SF.150.03.045 SF.150.04.045 SF.150.08.045 SF.150.RA.045</p>
	<p>45° 150 mm Pres döküm plaketli yan kapak 45° <i>150 mm Shutter frame in die cast aluminium with fixing plate housing</i></p>	<p>30 Çift <i>30 Pair</i></p>	<p>Pres <i>Mill finish</i> Beyaz <i>White</i> Gri <i>Grey</i> Kahve <i>Brown</i> Metalik gri <i>Silver metallic</i> Krem <i>Ivory</i> Seçilen RAL <i>Selected RAL</i></p>	<p>SF.150.00.B45 SF.150.01.B45 SF.150.02.B45 SF.150.03.B45 SF.150.04.B45 SF.150.08.B45 SF.150.RA.B45</p>



## YAN KAPAKLAR SIDE FRAMES

45°

8

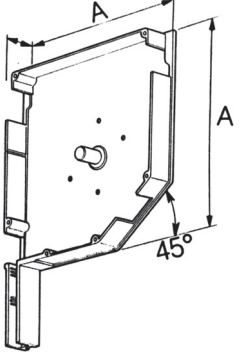
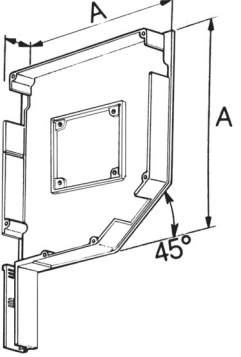
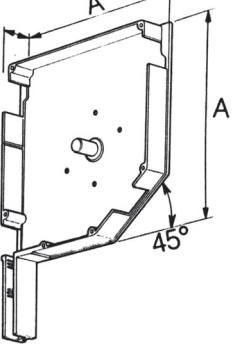
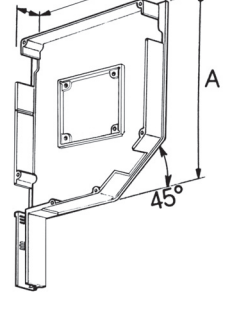
ÜRÜN İTEM	ÜRÜN ÖZELLİKLERİ PRODUCT DESCRIPTION	AMBALAJ PACKAGING	RENK COLOR	ÜRÜN KODU CODE
	<p><b>165 mm Yan Kapaklar</b> <b>165 mm Side Frames</b></p> <p>45° 165 mm pres döküm pimli yan kapak 45° <i>165 mm shutter frame in die cast aluminium with pivot</i></p>	30 Çift 30 Pair	Pres <i>Mill finish</i> Beyaz <i>White</i> Gri <i>Grey</i> Kahve <i>Brown</i> Metalik gri <i>Silver metallic</i> Krem <i>Ivory</i> Seçilen RAL <i>Selected RAL</i>	SF.165.00.045 SF.165.01.045 SF.165.02.045 SF.165.03.045 SF.165.04.045 SF.165.08.045 SF.165.RA.045
	<p>45° 165 mm pres döküm plaketsli yan kapak 45° <i>165 mm shutter frame in die cast aluminium with fixing plate housing</i></p>	30 Çift 30 Pair	Pres <i>Mill finish</i> Beyaz <i>White</i> Gri <i>Grey</i> Kahve <i>Brown</i> Metalik gri <i>Silver metallic</i> Krem <i>Ivory</i> Seçilen RAL <i>Selected RAL</i>	SF.165.00.B45 SF.165.01.B45 SF.165.02.B45 SF.165.03.B45 SF.165.04.B45 SF.165.08.B45 SF.165.RA.B45
	<p><b>180 mm Yan Kapaklar</b> <b>180 mm Side Frames</b></p> <p>45° 180 mm pres döküm pimli yan kapak 45° <i>180 mm shutter frame in die cast aluminium with pivot</i></p>	25 Çift 25 Pair	Pres <i>Mill finish</i> Beyaz <i>White</i> Gri <i>Grey</i> Kahve <i>Brown</i> Metalik gri <i>Silver metallic</i> Krem <i>Ivory</i> Seçilen RAL <i>Selected RAL</i>	SF.180.00.045 SF.180.01.045 SF.180.02.045 SF.180.03.045 SF.180.04.045 SF.180.08.045 SF.180.RA.045
	<p>45° 180 mm pres döküm plaketsli yan kapak 45° <i>180 mm shutter frame in die cast aluminium with fixing plate housing</i></p>	25 Çift 25 Pair	Pres <i>Mill finish</i> Beyaz <i>White</i> Gri <i>Grey</i> Kahve <i>Brown</i> Metalik gri <i>Silver metallic</i> Krem <i>Ivory</i> Seçilen RAL <i>Selected RAL</i>	SF.180.00.B45 SF.180.01.B45 SF.180.02.B45 SF.180.03.B45 SF.180.04.B45 SF.180.08.B45 SF.180.RA.B45

## YAN KAPAKLAR SIDE FRAMES

45°

8

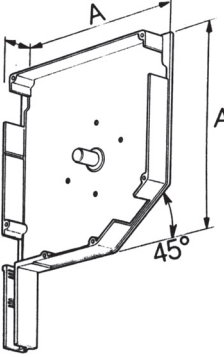
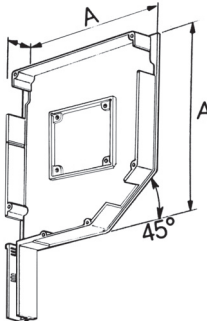
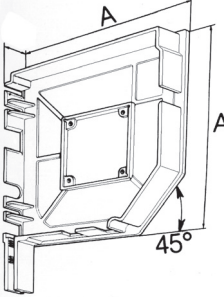
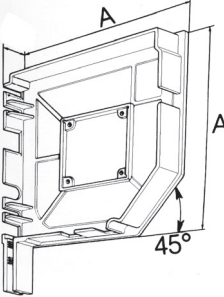
ÜRÜN İTEM	ÜRÜN ÖZELLİKLERİ PRODUCT DESCRIPTION	AMBALAJ PACKAGING	RENK COLOR	ÜRÜN KODU CODE
	<p><b>205 mm Yan Kapaklar</b> <b>205 mm Side Frames</b></p> <p>45° 205 mm pres döküm pimli yan kapak 45° 205 mm shutter frame in die cast aluminium with pivot</p>	<p>20 Çift 20 Pair</p>	<p>Pres <i>Mill finish</i> Beyaz <i>White</i> Gri <i>Grey</i> Kahve <i>Brown</i> Metalik gri <i>Silver metallic</i> Krem <i>Ivory</i> Seçilen RAL <i>Selected RAL</i></p>	<p>SF.205.00.045 SF.205.01.045 SF.205.02.045 SF.205.03.045 SF.205.04.045 SF.205.08.045 SF.205.RA.045</p>
	<p>45° 205 mm pres döküm plakalı yan kapak 45° 205 mm shutter frame in die cast aluminium with fixing plate housing</p>	<p>20 Çift 20 Pair</p>	<p>Pres <i>Mill finish</i> Beyaz <i>White</i> Gri <i>Grey</i> Kahve <i>Brown</i> Metalik gri <i>Silver metallic</i> Krem <i>Ivory</i> Seçilen RAL <i>Selected RAL</i></p>	<p>SF.205.00.B45 SF.205.01.B45 SF.205.02.B45 SF.205.03.B45 SF.205.04.B45 SF.205.08.B45 SF.205.RA.B45</p>
	<p><b>250 mm Yan Kapaklar</b> <b>250 mm Side Frames</b></p> <p>45° 250 mm pres döküm plaketli yan kapak 45° 250 mm shutter frame in die cast aluminium with fixing plate housing</p>	<p>15 Çift 15 Pair</p>	<p>Pres <i>Mill finish</i> Beyaz <i>White</i> Gri <i>Grey</i> Kahve <i>Brown</i> Metalik gri <i>Silver metallic</i> Krem <i>Ivory</i> Seçilen RAL <i>Selected RAL</i></p>	<p>SF.250.00.045 SF.250.01.045 SF.250.02.045 SF.250.03.045 SF.250.04.045 SF.250.08.045 SF.250.RA.045</p>
	<p><b>300 mm Yan Kapaklar</b> <b>300 mm Side Frames</b></p> <p>45° 300 mm pres döküm plaketli yan kapak 45° 300 mm shutter frame in die cast aluminium montaj plakası yuvası with fixing plate housing</p>	<p>10 Çift 10 Pair</p>	<p>Pres <i>Mill finish</i> Beyaz <i>White</i> Gri <i>Grey</i> Kahve <i>Brown</i> Metalik gri <i>Silver metallic</i> Krem <i>Ivory</i> Seçilen RAL <i>Selected RAL</i></p>	<p>SF.300.00.045 SF.300.01.045 SF.300.02.045 SF.300.03.045 SF.300.04.045 SF.300.08.045 SF.300.RA.045</p>

## YAN KAPAKLAR SIDE FRAMES

45°

8

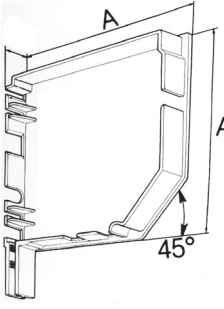
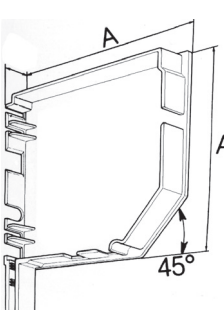
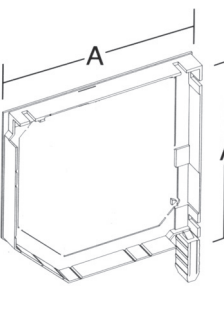
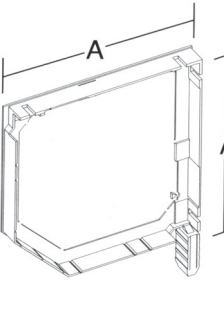
ÜRÜN ITEM	ÜRÜN ÖZELLİKLERİ PRODUCT DESCRIPTION	AMBALAJ PACKAGING	RENK COLOR	ÜRÜN KODU CODE
	<p>45° 300 mm galvanizli çelik yan kapak 45° 300 mm shutter frame in galvanized steel</p>	<p>10 Çift 10 Pair</p>	<p>Pres <i>Mill finish</i> Beyaz <i>White</i> Gri <i>Grey</i> Kahve <i>Brown</i> Metalik gri <i>Silver metallic</i> Krem <i>Ivory</i> Seçilen RAL <i>Selected RAL</i></p>	<p>SF.300.00.S45 SF.300.01.S45 SF.300.02.S45 SF.300.03.S45 SF.300.04.S45 SF.300.08.S45 SF.300.RA.S45</p>
	<p><b>330 mm Yan Kapaklar</b> <b>330 mm Side Frames</b> 45° 330 mm galvanizli çelik yan kapak 45° 330 mm shutter frame in galvanized steel</p>	<p>10 Çift 10 Pair</p>	<p>Pres <i>Mill finish</i> Beyaz <i>White</i> Gri <i>Grey</i> Kahve <i>Brown</i> Metalik gri <i>Silver metallic</i> Krem <i>Ivory</i> Seçilen RAL <i>Selected RAL</i></p>	<p>SF.330.00.S45 SF.330.01.S45 SF.330.02.S45 SF.330.03.S45 SF.330.04.S45 SF.330.08.S45 SF.330.RA.S45</p>
	<p><b>350 mm Yan Kapaklar</b> <b>350 mm Side Frames</b> 350 mm galvanizli çelik yan kapak 350 mm shutter frame in galvanized steel 45° galvanizli çelik 45° galvanizli steel</p>	<p>1 Çift 1 Pair</p>	<p>Pres <i>Mill finish</i> Beyaz <i>White</i> Gri <i>Grey</i> Kahve <i>Brown</i> Metalik gri <i>Silver metallic</i> Krem <i>Ivory</i> Seçilen RAL <i>Selected RAL</i></p>	<p>SF.350.00.045 SF.350.01.045 SF.350.02.045 SF.350.03.045 SF.350.04.045 SF.350.08.045 SF.350.RA.045</p>
	<p><b>400 mm Yan Kapaklar</b> <b>400 mm Side Frames</b> 400 mm galvanizli çelik yan kapak 400 mm shutter frame in galvanized steel 45° galvanizli çelik 45° galvanizli steel</p>	<p>1 Çift 1 Pair</p>	<p>Pres <i>Mill finish</i> Beyaz <i>White</i> Gri <i>Grey</i> Kahve <i>Brown</i> Metalik gri <i>Silver metallic</i> Krem <i>Ivory</i> Seçilen RAL <i>Selected RAL</i></p>	<p>SF.400.00.045 SF.400.01.045 SF.400.02.045 SF.400.03.045 SF.400.04.045 SF.400.08.045 SF.400.RA.045</p>

## YAN KAPAKLAR SIDE FRAMES

45°

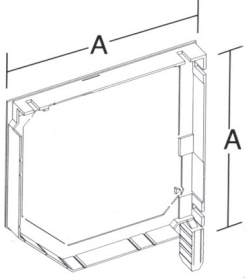
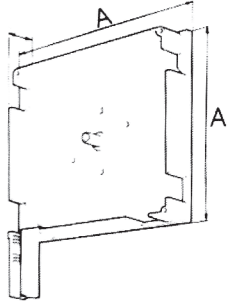
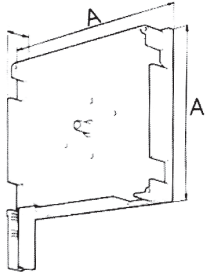
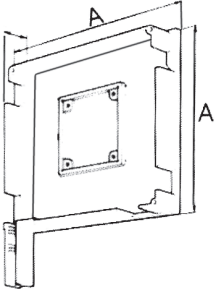
ÜRÜN İTEM	ÜRÜN ÖZELLİKLERİ PRODUCT DESCRIPTION	AMBALAJ PACKAGING	RENK COLOR	ÜRÜN KODU CODE
	<p><b>440 mm Yan Kapaklar</b> <b>440 mm Side Frames</b></p> <p>440 mm galvanizli çelik yan kapak <i>440 mm shutter frame in galvanized steel</i></p> <p>45° galvanizli çelik <i>45° galvanized steel</i></p>	<p>1 Çift <i>1 Pair</i></p>	<p>Pres <i>Mill finish</i> Beyaz <i>White</i> Gri <i>Grey</i> Kahve <i>Brown</i> Metalik gri <i>Silver metallic</i> Krem <i>Ivory</i> Seçilen RAL <i>Selected RAL</i></p>	<p>SF.440.00.045 SF.440.01.045 SF.440.02.045 SF.440.03.045 SF.440.04.045 SF.440.08.045 SF.440.RA.045</p>
<b>90°</b>				
	<p>90° 165 mm pres döküm pimli kare yan kapak <i>90° 165 mm square shutter frame in die cast aluminium with pivot</i></p>	<p>30 Çift <i>30 Pair</i></p>	<p>Pres <i>Mill finish</i> Beyaz <i>White</i> Gri <i>Grey</i> Kahve <i>Brown</i> Metalik gri <i>Silver metallic</i> Krem <i>Ivory</i> Seçilen RAL <i>Selected RAL</i></p>	<p>SF.165.00.090 SF.165.01.090 SF.165.02.090 SF.165.03.090 SF.165.04.090 SF.165.08.090 SF.165.RA.090</p>
	<p>90° 180 mm pres döküm pimli kare yan kapak <i>90° 180 mm square shutter frame in die cast aluminium with pivot</i></p>	<p>25 Çift <i>25 Pair</i></p>	<p>Pres <i>Mill finish</i> Beyaz <i>White</i> Gri <i>Grey</i> Kahve <i>Brown</i> Metalik gri <i>Silver metallic</i> Krem <i>Ivory</i> Seçilen RAL <i>Selected RAL</i></p>	<p>SF.180.00.090 SF.180.01.090 SF.180.02.090 SF.180.03.090 SF.180.04.090 SF.180.08.090 SF.180.RA.090</p>
	<p>90° 180 mm pres döküm plaketsli kare yan kapak <i>90° 180 mm square shutter frame in die cast aluminium with fixing plate housing</i></p>	<p>25 Çift <i>25 Pair</i></p>	<p>Pres <i>Mill finish</i> Beyaz <i>White</i> Gri <i>Grey</i> Kahve <i>Brown</i> Metalik gri <i>Silver metallic</i> Krem <i>Ivory</i> Seçilen RAL <i>Selected RAL</i></p>	<p>SF.180.00.B90 SF.180.01.B90 SF.180.02.B90 SF.180.03.B90 SF.180.04.B90 SF.180.08.B90 SF.180.RA.B90</p>

8

## YAN KAPAKLAR SIDE FRAMES

90°

8

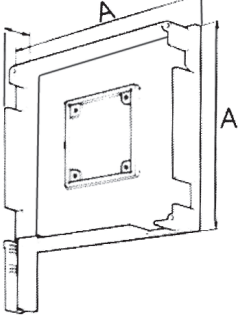
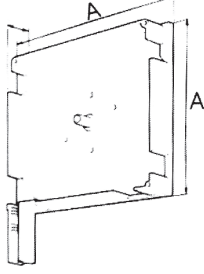
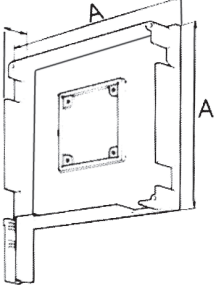
ÜRÜN İTEM ITEM	ÜRÜN ÖZELLİKLERİ PRODUCT DESCRIPTION	AMBALAJ PACKAGING	RENK COLOR	ÜRÜN KODU CODE
	<p>90° 165 mm pres döküm plaketli kare yan kapak 90° <i>165 mm square shutter frame in die cast aluminium with fixing plate housing</i></p>	<p>30 Çift <i>30 Pair</i></p>	<p>Pres <i>Mill finish</i> Beyaz <i>White</i> Gri <i>Grey</i> Kahve <i>Brown</i> Metalik gri <i>Silver metallic</i> Krem <i>Ivory</i> Seçilen RAL <i>Selected RAL</i></p>	<p>SF.165.00.B90 SF.165.01.B90 SF.165.02.B90 SF.165.03.B90 SF.165.04.B90 SF.165.08.B90 SF.165.RA.B90</p>
	<p>90° 205 mm pres döküm pimli kare yan kapak 90° <i>205 mm square shutter frame in die cast aluminium with pivot</i></p>	<p>20 Çift <i>20 Pair</i></p>	<p>Pres <i>Mill finish</i> Beyaz <i>White</i> Gri <i>Grey</i> Kahve <i>Brown</i> Metalik gri <i>Silver metallic</i> Krem <i>Ivory</i> Seçilen RAL <i>Selected RAL</i></p>	<p>SF.205.00.090 SF.205.01.090 SF.205.02.090 SF.205.03.090 SF.205.04.090 SF.205.08.090 SF.205.RA.090</p>
	<p>90° 205 mm pres döküm plaketli kare yan kapak 90° <i>205 mm square shutter frame in die cast aluminium with fixing plate housing</i></p>	<p>20 Çift <i>20 Pair</i></p>	<p>Pres <i>Mill finish</i> Beyaz <i>White</i> Gri <i>Grey</i> Kahve <i>Brown</i> Metalik gri <i>Silver metallic</i> Krem <i>Ivory</i> Seçilen RAL <i>Selected RAL</i></p>	<p>SF.205.00.B90 SF.205.01.B90 SF.205.02.B90 SF.205.03.B90 SF.205.04.B90 SF.205.08.B90 SF.205.RA.B90</p>

**YAN KAPAKLAR (OVAL)**  
**SIDE FRAME (OVAL)**

8

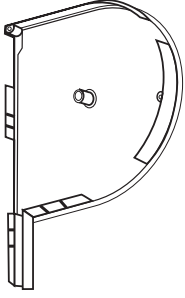
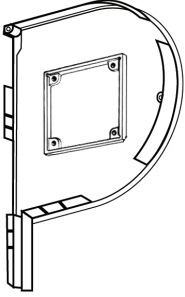
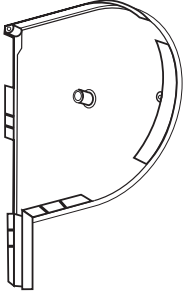
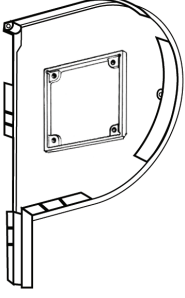
ÜRÜN İTEM	ÜRÜN ÖZELLİKLERİ PRODUCT DESCRIPTION	AMBALAJ PACKAGING	RENK COLOR	ÜRÜN KODU CODE
	<p><b>137 mm Yuvarlak Yan Kapaklar</b> <b>137 mm Round Side Frames</b></p> <p>137 mm pres döküm pimli yuvarlak yan kapak <i>137 mm round shutter frame in die cast aluminium with pivot</i></p>	30 Çift <i>30 Pair</i>	<p>Pres <i>Mill finish</i></p> <p>Beyaz <i>White</i></p> <p>Kahve <i>Brown</i></p> <p>Metalik gri <i>Silver metallic</i></p> <p>Seçilen RAL <i>Selected RAL</i></p>	<p>SF.137.00.ROY</p> <p>SF.137.01.ROY</p> <p>SF.137.03.ROY</p> <p>SF.137.04.ROY</p> <p>SF.137.RA.ROY</p>
	<p>137 mm pres döküm plaketsli yuvarlak yan kapak <i>137 mm round shutter frame in die cast aluminium with fixing plate housing</i></p>	30 Çift <i>30 Pair</i>	<p>Pres <i>Mill finish</i></p> <p>Beyaz <i>White</i></p> <p>Kahve <i>Brown</i></p> <p>Metalik gri <i>Silver metallic</i></p> <p>Seçilen RAL <i>Selected RAL</i></p>	<p>SF.137.00.ROB</p> <p>SF.137.01.ROB</p> <p>SF.137.03.ROB</p> <p>SF.137.04.ROB</p> <p>SF.137.RA.ROB</p>
	<p><b>165 mm Yuvarlak Yan Kapaklar</b> <b>165 mm Round Side Frames</b></p> <p>165 mm pres döküm pimli yuvarlak yan kapak <i>165 mm round shutter frame in die cast aluminium with pivot</i></p>	30 Çift <i>30 Pair</i>	<p>Pres <i>Mill finish</i></p> <p>Beyaz <i>White</i></p> <p>Kahve <i>Brown</i></p> <p>Metalik gri <i>Silver metallic</i></p> <p>Seçilen RAL <i>Selected RAL</i></p>	<p>SF.165.00.ROY</p> <p>SF.165.01.ROY</p> <p>SF.165.03.ROY</p> <p>SF.165.04.ROY</p> <p>SF.165.RA.ROY</p>
	<p>165 mm pres döküm plaketsli yuvarlak yan kapak <i>165 mm round shutter frame in die cast aluminium with fixing plate housing</i></p>	30 Çift <i>30 Pair</i>	<p>Pres <i>Mill finish</i></p> <p>Beyaz <i>White</i></p> <p>Kahve <i>Brown</i></p> <p>Metalik gri <i>Silver metallic</i></p> <p>Seçilen RAL <i>Selected RAL</i></p>	<p>SF.165.00.ROB</p> <p>SF.165.01.ROB</p> <p>SF.165.03.ROB</p> <p>SF.165.04.ROB</p> <p>SF.165.RA.ROB</p>



**YAN KAPAKLAR (OVAL)**  
**SIDE FRAME (OVAL)**

8

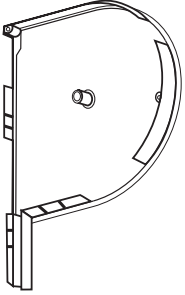
ÜRÜN ITEM	ÜRÜN ÖZELLİKLERİ PRODUCT DESCRIPTION	AMBALAJ PACKAGING	RENK COLOR	ÜRÜN KODU CODE
	<p><b>205 mm Yuvarlak Yan Kapaklar</b> <b>205 mm Round Side Frames</b></p> <p>205 mm pres döküm pimli yuvarlak yan kapak <i>205 mm round shutter frame in die cast aluminium with pivot</i></p>	<p>30 Çift <i>30 Pair</i></p>	<p>Pres <i>Mill finish</i> Beyaz <i>White</i> Kahve <i>Brown</i> Metalik gri <i>Silver metallic</i> Seçilen RAL <i>Selected RAL</i></p>	<p>SF.205.00.ROY SF.205.01.ROY SF.205.03.ROY SF.205.04.ROY SF.205.RA.ROY</p>
	<p>205 mm pres döküm plaketsli yuvarlak yan kapak <i>205 mm round shutter frame in die cast aluminium with fixing plate housing</i></p>	<p>30 Çift <i>30 Pair</i></p>	<p>Pres <i>Mill finish</i> Beyaz <i>White</i> Kahve <i>Brown</i> Metalik gri <i>Silver metallic</i> Seçilen RAL <i>Selected RAL</i></p>	<p>SF.205.00.ROB SF.205.01.ROB SF.205.03.ROB SF.205.04.ROB SF.205.RA.ROB</p>

## Yan Kapak İçi Plaketler

### *Brackets*

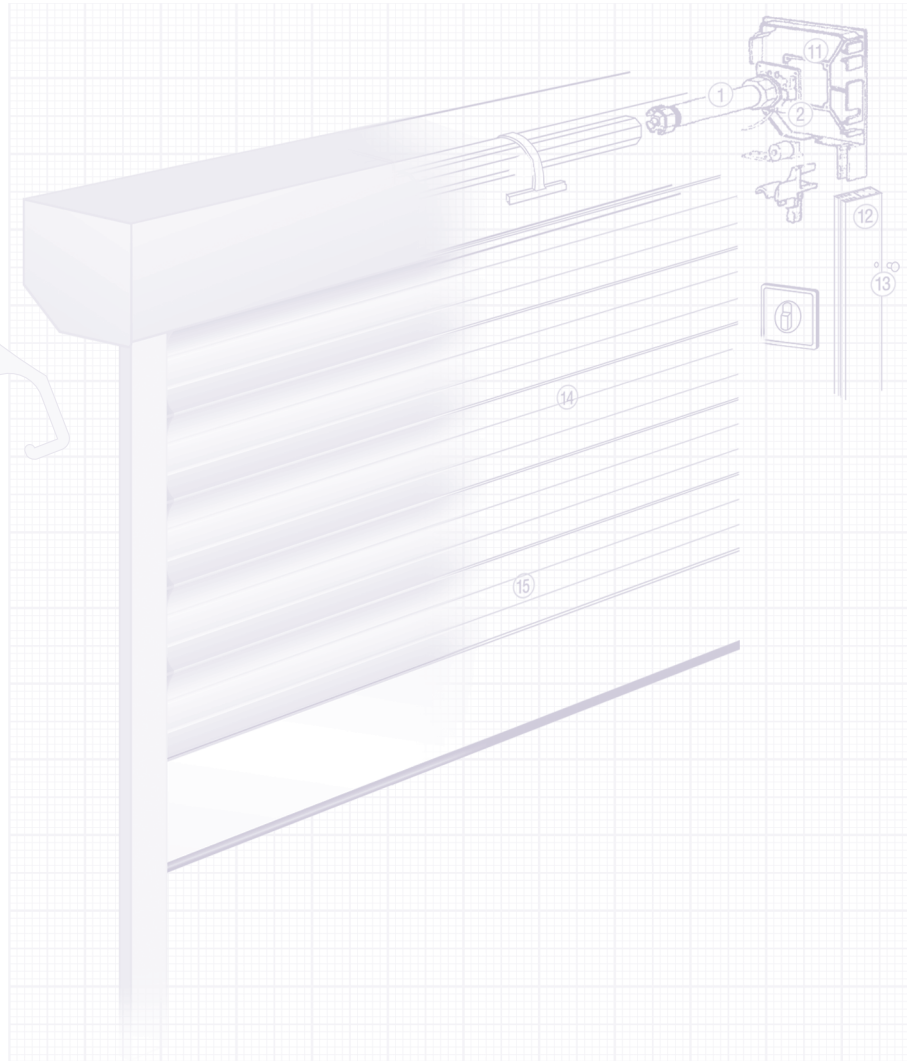

- 1
- 2
- 3
- 4
- 5
- 6
- 7
- 8
- 9
- 10
- 11
- 12
- 13
- 14
- 15
- 16
- 17
- 18
- 19
- 20
- 21
- 22
- 23
- 24
- 25
- 26
- 27
- 28
- 29

## YAN KAPAK İÇİ PLAKETLER BRACKETS

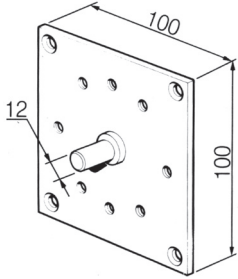
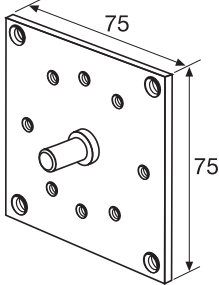
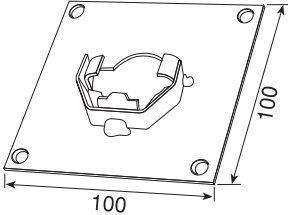
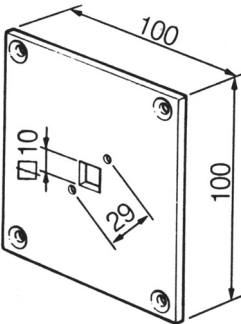
ÜRÜN İTEM	ÜRÜN ÖZELLİKLERİ PRODUCT DESCRIPTION	AMBALAJ PACKAGING	ÜRÜN KODU CODE
	<p>Galvanizli çelik pimli kare plaket <i>Galvanized steel square bracket with pivot</i></p> <p>Pimli plaket 250-300 mm. alüminyum yan kapaklar ve tüm orta yataklar için. <i>Bracket with pivot for 250-300 mm. aluminium side frames and for all middle frames</i></p>	<p>100 Adet <i>100 Pieces</i></p>	<p>BR.100.00.PIV</p>
	<p>Pimli plaket 137-165-180-205 mm. alüminyum yan kapaklar ve tüm orta yataklar için. <i>Bracket with pivot for 137-165-180-205 mm. aluminium side frames and for all middle frames</i></p>	<p>100 Adet <i>100 Pieces</i></p>	<p>BR.075.00.PIV</p>
	<p>Galvanizli çelik 42 mm.lik rulman plaketi <i>Galvanized steel square bracket for 42 mm ball bearing</i></p> <p>250-300-350-400 mm.lik yan kapak uyumlu. <i>for 250-300-350-400 mm. end caps</i></p>	<p>100 Adet <i>100 Pieces</i></p>	<p>BR.100.00.ROB</p>
	<p>Galvanizli çelik tüp motor yatak plaketi <i>Galvanized steel square bracket for tubular motor</i></p>	<p>100 Adet <i>100 Pieces</i></p>	<p>BR.100.00.MOT</p>

## YAN KAPAK İÇİ PLAKETLER BRACKETS

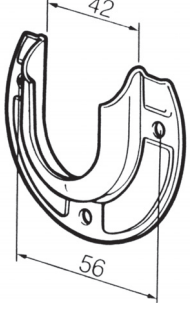
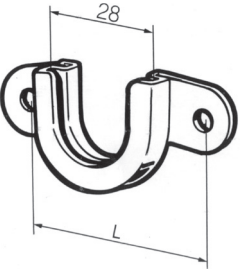
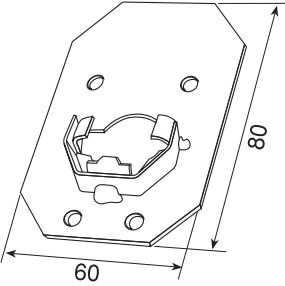
ÜRÜN İTEM	ÜRÜN ÖZELLİKLERİ PRODUCT DESCRIPTION	AMBALAJ PACKAGING	ÜRÜN KODU CODE
9 	Galvanizli çelik, 42 mm rulman kaseti <i>Galvanized steel, for ball bearing 42 mm</i>	100 Adet <i>100 Pieces</i>	BR.056.00.C42
	Galvanizli çelik, 28 mm rulman kaseti <i>Galvanized steel, for ball bearing 28 mm</i>	100 Adet <i>100 Pieces</i>	BR.042.00.C28
	Galvanizli çelik, 42 mm.lik rulman duvar plaketi <i>Galvanized steel, wall bracket for ball bearing 42 mm</i>	100 Adet <i>100 Pieces</i>	BR.060.00.C42

## YAN KAPAK İÇİ PLAKETLER BRACKETS

9

ÜRÜN İTEM	ÜRÜN ÖZELLİKLERİ PRODUCT DESCRIPTION	AMBALAJ PACKAGING	ÜRÜN KODU CODE
	<p>Galvanizli çelik, 75 mm. kare 42 mm rulman kaseti <i>Galvanized steel, 75 mm. square for ball bearing 42 mm</i></p> <p>137 mm-165 mm-180 mm-205 mm pimsiz yan kapaklar için <i>For 137 mm-165 mm-180 mm 205 mm side frames without pivot</i></p>	<p>100 Adet <i>100 Pieces</i></p>	BR.075.00.ROB
	<p>Galvanizli çelik, 75 mm. kare yan kapak tüp motor yatağı <i>Galvanized steel, 75 mm. square side frames bracket for tubular motors</i></p> <p>137 mm-165 mm-180 mm-205 mm pimsiz yan kapaklar için Elero 9 serisi, Mosel SEL-60 TYP serisi uyumlu <i>For 137 mm-165 mm-180 mm 205 mm side frames without pivot and elero 9 series, Mosel SEL-60 TYP series.</i></p>	<p>100 Adet <i>100 Pieces</i></p>	BR.075.60.MOT
	<p>Galvanizli çelik, 75 mm. kare yan kapak tüp motor yatağı <i>Galvanized steel, 75 mm. square side frames bracket for tubular motors</i></p> <p>137 mm-165 mm-180 mm-205 mm pimsiz yan kapaklar için Elero 11 serisi, Mosel SEL-70 TYP serisi uyumlu. <i>For 137 mm-165 mm-180 mm 205 mm side frames without pivot and elero 11 series, Mosel SEL-70 TYP series.</i></p>	<p>100 Adet <i>100 Pieces</i></p>	BR.075.70.MOT

## Sekizgen ve Yuvarlak Borular

### *Octogonal and Round Tubes*

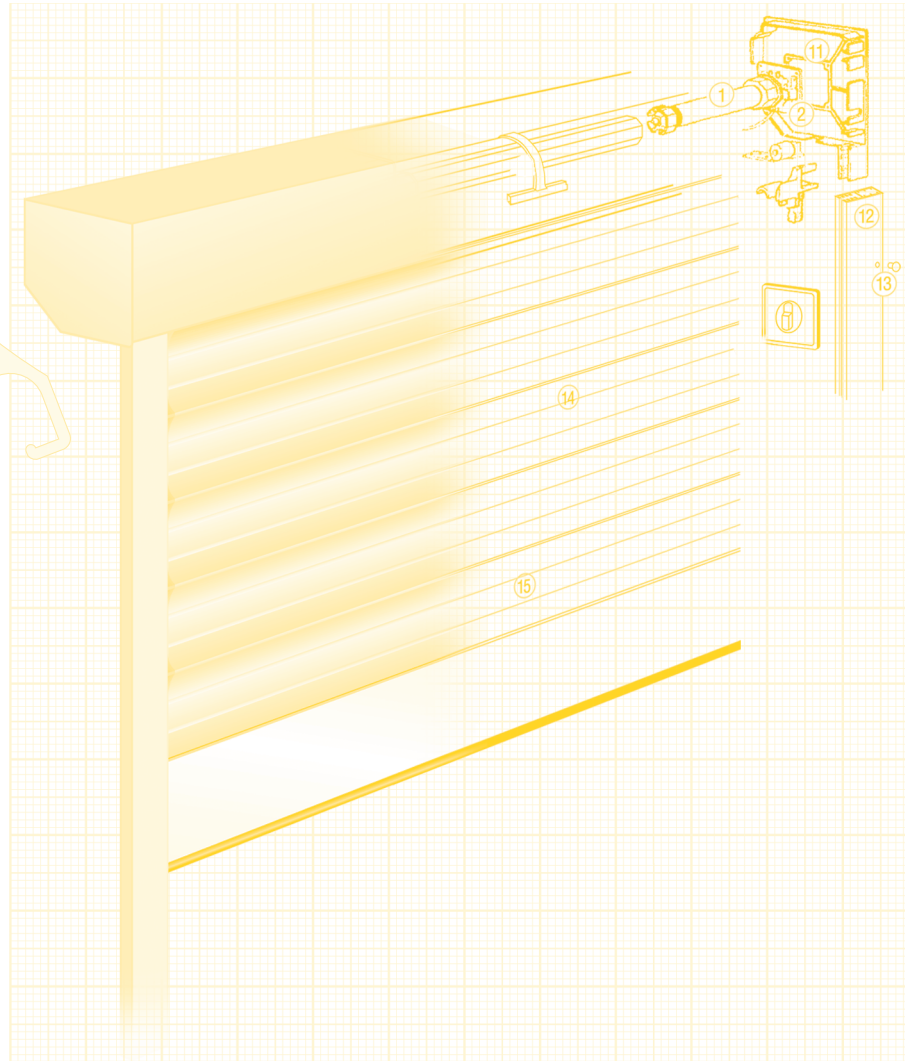

- 1
- 2
- 3
- 4
- 5
- 6
- 7
- 8
- 9
- 10
- 11
- 12
- 13
- 14
- 15
- 16
- 17
- 18
- 19
- 20
- 21
- 22
- 23
- 24
- 25
- 26
- 27
- 28
- 29

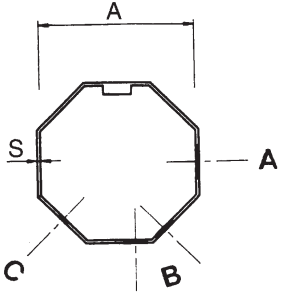
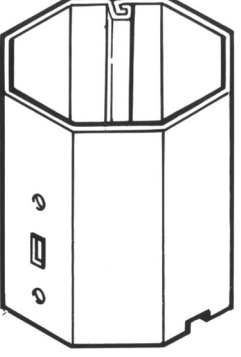

## SEKİZGEN BORULAR OCTOGONAL TUBES

ÜRÜN ITEM	ÜRÜN ÖZELLİKLERİ PRODUCT DESCRIPTION	AMBALAJ PACKAGING	ÜRÜN KODU CODE
	<p>Galvanizli sekizgen 40 mm çapında borular <i>Octagonal galvanized 40 mm diameter tubes</i></p> <p>Et kalınlık <i>Material Thickness</i> 0.40 mm 0.50 mm 0.60 mm</p> <p>Standart üretim boyu 6 m <i>Standard length 6 m</i></p>	<p>12 Adet <i>12 Bars</i></p>	<p>TU.040.00.040 TU.040.00.050 TU.040.00.060</p>
	<p>Galvanizli sekizgen 60 mm çapında borular <i>Octagonal galvanized 60 mm diameter tubes</i></p> <p>Et kalınlık <i>Material Thickness</i> 0.60 mm 0.80 mm</p> <p>Standart üretim boyu 6 m <i>Standard length 6 m</i></p>	<p>6 Adet <i>6 Bars</i></p>	<p>TU.060.00.060 TU.060.00.080</p>
	<p>Galvanizli sekizgen 70 mm çapında borular <i>Octagonal galvanized 70 mm diameter tubes</i></p> <p>Et kalınlık <i>Material Thickness</i> 1.00 mm 1.20 mm</p> <p>Standart üretim boyları <i>Standard length</i> 4 m. - 4,50 m - 5 m - 5,50 m. 6 m. - 6,50 m - 7 m - 7,50 m.</p>	<p>3 Adet <i>3 Bars</i></p>	<p>TU.070.00.100 TU.070.00.120</p>

## YUVARLAK BORULAR ROUND TUBES

ÜRÜN ITEM	ÜRÜN ÖZELLİKLERİ PRODUCT DESCRIPTION	AMBALAJ PACKAGING	ÜRÜN KODU CODE
	<p>Yuvarlak galvanizli borular <i>Round galvanized tubes</i></p> <p>89 mm çap, 2 mm kalınlık <i>89 mm diameter, 2 mm thickness</i></p> <p>Standart üretim boyu 6 m <i>Standard length 6 m</i></p>	<p>1 Adet <i>1 Bar</i></p>	TU.089.00.200
	<p>102 mm çap, 2 mm kalınlık <i>102 mm diameter, 2 mm thickness</i></p> <p>Standart üretim boyu 6 m <i>Standard length 6 m</i></p>	<p>1 Adet <i>1 Bar</i></p>	TU.102.00.200
	<p>114 mm çap, 3 mm kalınlık <i>114 mm diameter, 3 mm thickness</i></p> <p>Standart üretim boyu 6 m <i>Standard length 6 m</i></p>	<p>1 Adet <i>1 Bar</i></p>	TU.114.00.200
	<p>140 mm çap, 4.85 mm kalınlık <i>140 mm diameter, 4.85 mm thickness</i></p> <p>Standart üretim boyu 6 m <i>Standard length 6 m</i></p>	<p>1 Adet <i>1 Bar</i></p>	TU.140.00.200
	<p>159 mm çap, 4.85 mm kalınlık <i>159 mm diameter, 4.85 mm thickness</i></p> <p>Standart üretim boyu 6 m <i>Standard length 6 m</i></p>	<p>1 Adet <i>1 Bar</i></p>	TU.159.00.200
	<p>219 mm çap, 4.5 mm kalınlık <i>219 mm diameter, 4.5 mm thickness</i></p> <p>Standart üretim boyu 6 m <i>Standard length 6 m</i></p>	<p>1 Adet <i>1 Bar</i></p>	TU.219.00.200
	<p>Yuvarlak alüminyum perde boruları <i>Round aluminium stor tubes</i></p> <p>47 mm çap, 1.4 mm kalınlık <i>47 mm diameter, 1.4 mm thickness</i></p> <p>Standart üretim boyu 6 m <i>Standard length 6 m</i></p>	<p>1 Adet <i>1 Bar</i></p>	SE.446.47.BOR

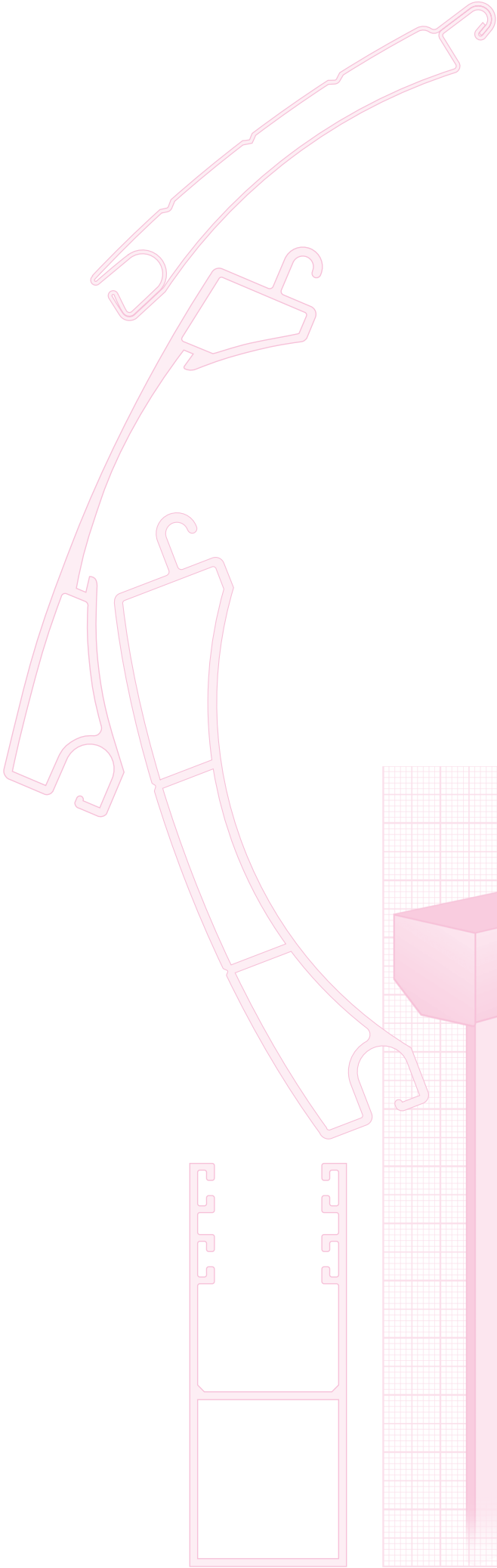

## Boru Başları

### Caps

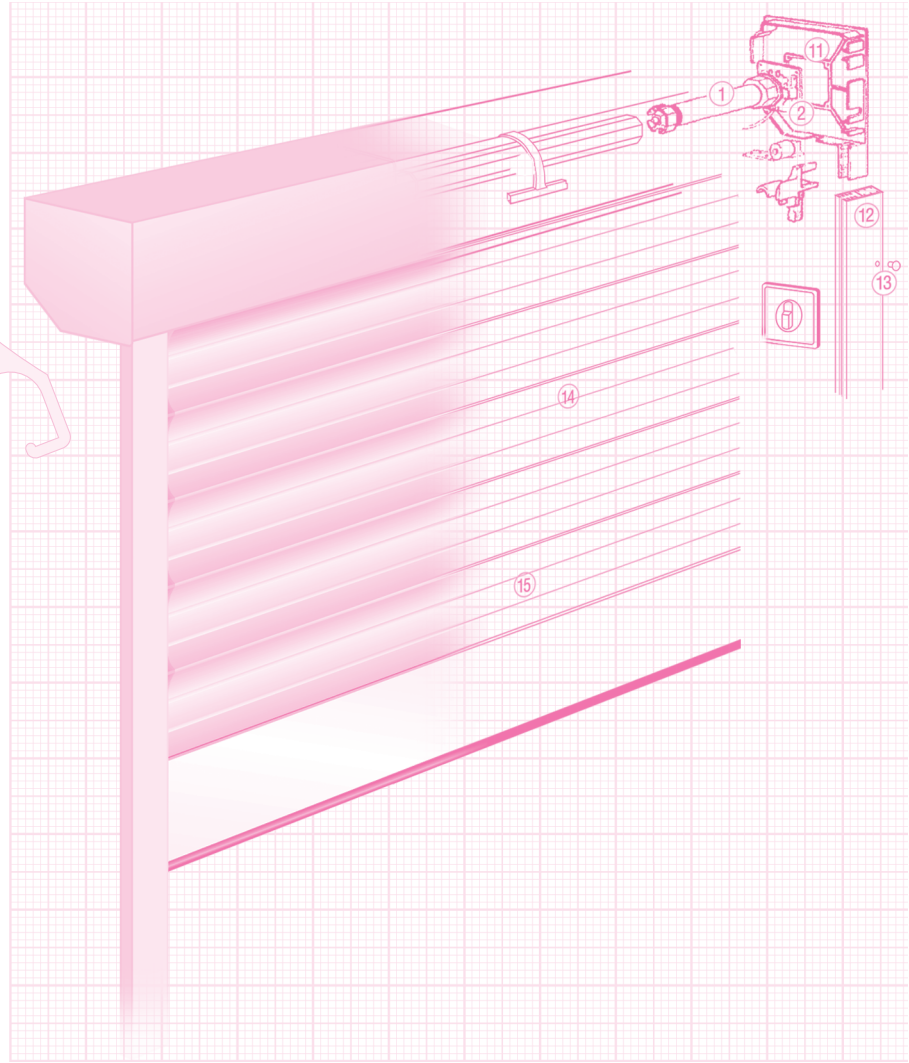

- 1
- 2
- 3
- 4
- 5
- 6
- 7
- 8
- 9
- 10
- 11
- 12
- 13
- 14
- 15
- 16
- 17
- 18
- 19
- 20
- 21
- 22
- 23
- 24
- 25
- 26
- 27
- 28
- 29

## BORU BAŞLARI CAPS

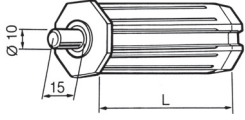
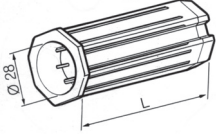
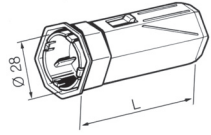
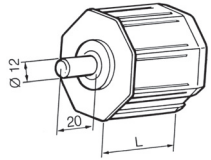
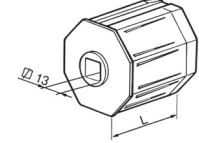
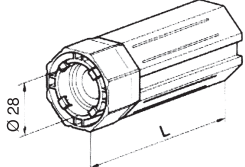
ÜRÜN İTEM	ÜRÜN ÖZELLİKLERİ PRODUCT DESCRIPTION	AMBALAJ PACKAGING	ÜRÜN KODU CODE
	Plastik boru başı, 40 mm <i>Plastic cap 40 mm tube</i>  pim çapı 12 mm L= 47 mm <i>d=12 mm pivot L= 47 mm</i>	200 Adet <i>200 Pieces</i>	CP.040.00.PPS
	28 mm rulman için L= 78 mm <i>For ball bearing 28 mm L= 78 mm</i>	200 Adet <i>200 Pieces</i>	CP.040.00.PWL
	Klipsli, kasnak için L= 102 mm <i>With clips for pulley L= 102 mm</i>	250 Adet <i>250 Pieces</i>	CP.040.00.PCL
	Plastik boru başı 60 mm <i>Plastic cap 60 mm tube</i>  Yuvarlak pimli 12 mm L= 57 mm <i>With round pivot 12 mm L= 57 mm</i>	100 Adet <i>100 Pieces</i>	CP.060.00.PPI
	Kare delikli 13 mm L=57 <i>With square hole 13 mm L=57</i>	200 Adet <i>200 Pieces</i>	CP.060.00.PHO
	28 mm rulman için L=100 <i>For ball bearing 28 mm L=100</i>	250 Adet <i>250 Pieces</i>	CP.060.00.PWI

## BORU BAŞLARI CAPS

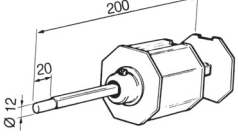
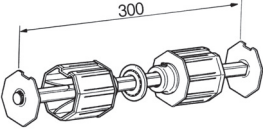
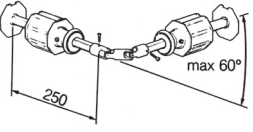
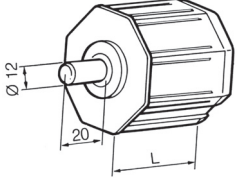
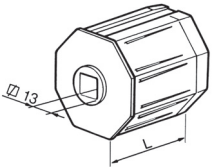
ÜRÜN ITEM	ÜRÜN ÖZELLİKLERİ PRODUCT DESCRIPTION	AMBALAJ PACKAGING	ÜRÜN KODU CODE
	<p>60 mm alüminyum uzatmalı, ayarlanabilir boru başı, pimli 12 mm L=200 <i>Aluminium cap 60 mm tube Adjust. pivot 12 mm L=200</i></p>	<p>10 Adet <i>10 Pieces</i></p>	<p>CP.060.00.AAD</p>
	<p>60 mm PVC ayarlanabilir ara bağlantı L=300 <i>PVC cap 60 mm tube Double adjustable L=300</i></p>	<p>25 Adet <i>25 Pieces</i></p>	<p>CP.060.00.PDA</p>
	<p>Ayarlanabilir köşe mafsalı L= 2 x 250 maksimum açı 60° <i>PVC cap 60 mm tube Adjustable articulated L=2x250 Maximum angle 60°</i></p>	<p>10 Adet <i>10 Pieces</i></p>	<p>CP.060.00.PAA</p>
	<p>Alüminyum boru başı 60 mm <i>Aluminium cap 60 mm tube</i></p> <p>Yuvarlak pimli 12 mm L= 51 <i>With round pivot 12 mm L=51</i></p>	<p>100 Adet <i>100 Pieces</i></p>	<p>CP.060.00.API</p>
	<p>Alüminyum redüktör boru başı 60 mm <i>Aluminium cap 60 mm tube</i></p> <p>Kare delik 13 mm L=51 mm <i>Square hole 13 mm L=51 mm</i></p>	<p>100 Adet <i>100 Pieces</i></p>	<p>CP.060.00.AHO</p>

## BORU BAŞLARI CAPS

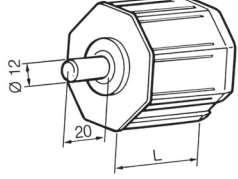
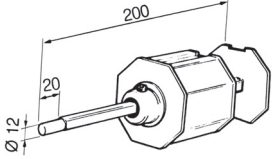
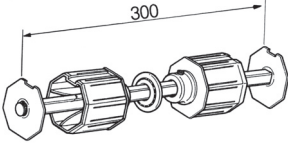
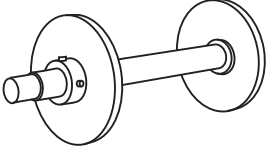
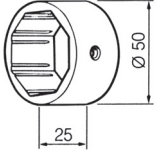
ÜRÜN İTEM	ÜRÜN ÖZELLİKLERİ PRODUCT DESCRIPTION	AMBALAJ PACKAGING	ÜRÜN KODU CODE
	Alüminyum boru başı 70 mm <i>Aluminium cap 70 mm tube</i>  Yuvarlak pimli, 12 mm L=51 <i>With round pivot 12 mm L=51</i>	50 Adet <i>50 Pieces</i>	CP.070.00.API
	70 mm alüminyum uzatmalı, ayarlanabilir boru başı, pimli 12 mm L=200 <i>Aluminium cap 70 mm tube Adjust. pivot 12 mm L=200</i>	50 Adet <i>50 Pieces</i>	CP.070.00.AAD
	70 mm PVC ayarlanabilir ara bağlantı L=300 <i>PVC cap 70 mm tube Double adjustable L=300</i>	25 Adet <i>25 Pieces</i>	CP.070.00.PDA
	90 x 2 mm çelik, yuvarlak ayarlanabilir boru başı <i>Steel round adjustable caps for round tube 90 x 2 mm</i>	10 Adet <i>10 Pieces</i>	CP.090.00.SRA
	98 x 2 mm çelik, yuvarlak ayarlanabilir boru başı <i>Steel round adjustable caps for round tube 98 x 2 mm</i>	10 Adet <i>10 Pieces</i>	CP.098.00.SRA
	Yuvarlak boru 133 x 2 mm <i>For round tube 133 x 2 mm</i>	10 Adet <i>10 Pieces</i>	CP.133.00.SRA
	139 x 2 mm çelik, yuvarlak ayarlanabilir boru başı <i>Steel round adjustable caps for round tube 139 x 2 mm</i>	10 Adet <i>10 Pieces</i>	CP.139.00.SRA
	Yuvarlak boru 159 x 2.6 mm <i>For round tube 159 x 2.6 mm</i>	10 Adet <i>10 Pieces</i>	CP.159.00.SRA
	Plastik bilezikler <i>Plastic rings</i>		
	60 mm > 80 mm	150 Adet / <i>150 Pieces</i>	CP.060.00.080
	70 mm > 80 mm	200 Adet / <i>200 Pieces</i>	CP.070.00.080
	70 mm > 101 mm	100 Adet / <i>100 Pieces</i>	CP.070.00.101
	70 mm > 120 mm	100 Adet / <i>100 Pieces</i>	CP.070.00.120





## Dikmeli "U" Başları

### Entry Guides

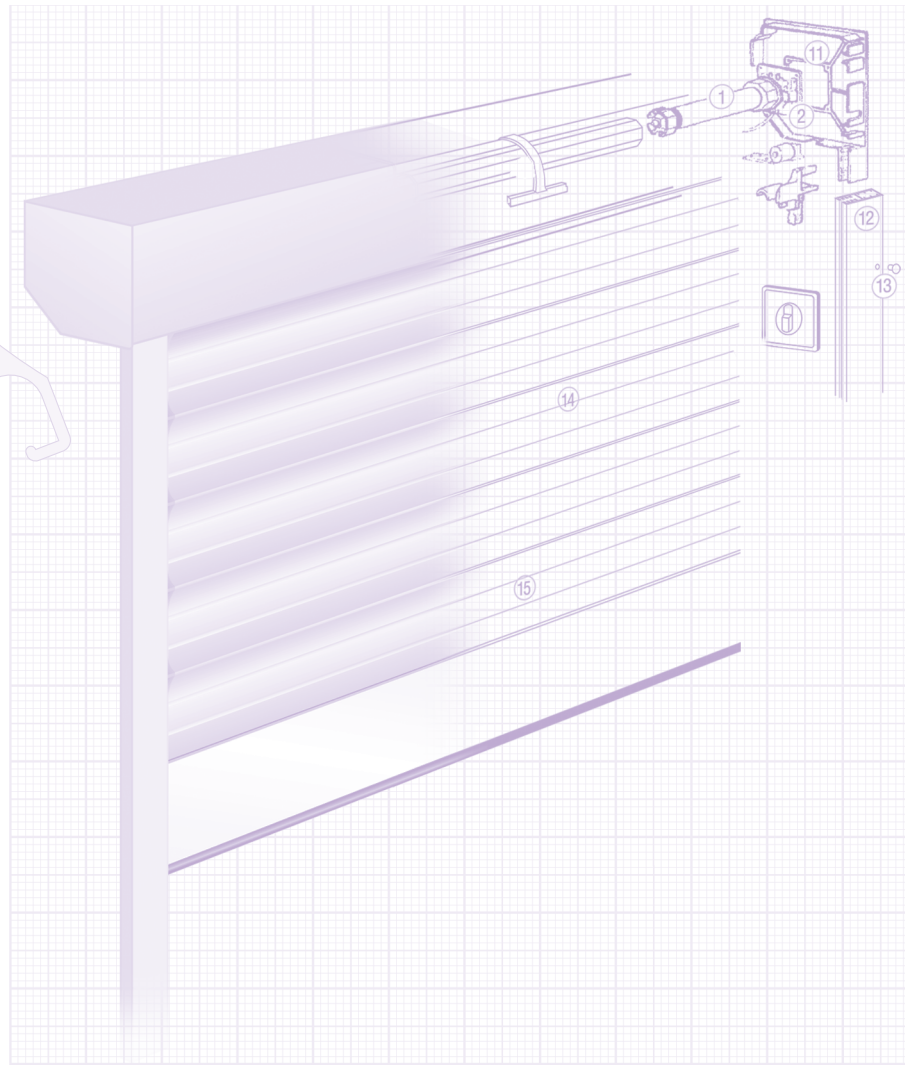

- 1
- 2
- 3
- 4
- 5
- 6
- 7
- 8
- 9
- 10
- 11
- 12
- 13
- 14
- 15
- 16
- 17
- 18
- 19
- 20
- 21
- 22
- 23
- 24
- 25
- 26
- 27
- 28
- 29

## DİKMELİ U BAŞLARI ENTRY GUIDES

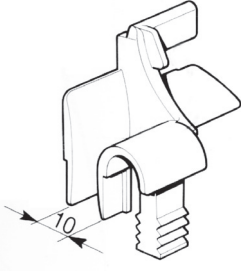
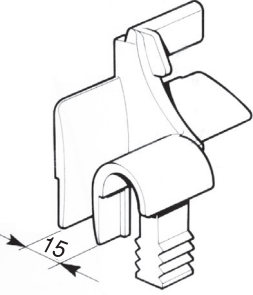
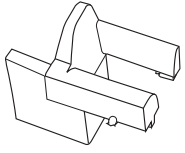
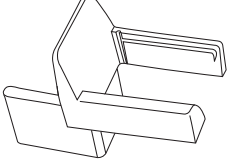
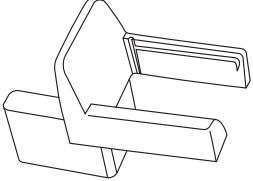
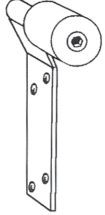
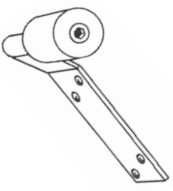
ÜRÜN İTEM	ÜRÜN ÖZELLİKLERİ PRODUCT DESCRIPTION	AMBALAJ PACKAGING	RENK COLOR	ÜRÜN KODU CODE
	Dikmeli U başı – mini – 54 x 21 GC.456 uyumlu <i>Entry guide – mini – for GC.456- 54 x 21</i>	200 Adet <i>200 Pieces</i>	Beyaz <i>White</i> Kahve <i>Brown</i>	EG.010.01.MIN EG.010.03.MIN
	Dikmeli U başı – standart- <i>Entry guide – standard-</i>	200 Adet <i>200 Pieces</i>	Beyaz <i>White</i> Kahve <i>Brown</i>	EG.015.01.STA EG.015.03.STA
	Özel dikmeli U başlığı 54 x 21 GC.424 uyumlu <i>Entry guide for GC.424- 54 x 21</i>	200 Adet <i>200 Pieces</i>	Siyah <i>Black</i>	EG.456.00.MIN
	Özel dikmeli U başlığı 55 x 26 GC.435 uyumlu <i>Entry guide for GC.435- 55 x 26</i>	200 Adet <i>200 Pieces</i>	Siyah <i>Black</i>	EG.435.00.STA
	Özel dikmeli U başlığı 70 x 26 GC.403 uyumlu <i>Entry guide for GC.403- 70 x 26</i>	200 Adet <i>200 Pieces</i>	Siyah <i>Black</i>	EG.403.00.STA
	Dikmeli U makarası <i>Entry guide with roller</i>	50 Adet <i>50 Pieces</i>		EG.000.00.ROL
	Dikmeli U makarası (polyamid) <i>Entry guide with roller (polyamide)</i>	50 Adet <i>50 Pieces</i>		EG.000.01.ROL



**Kilitler**  
**Security Blocks and Locks**

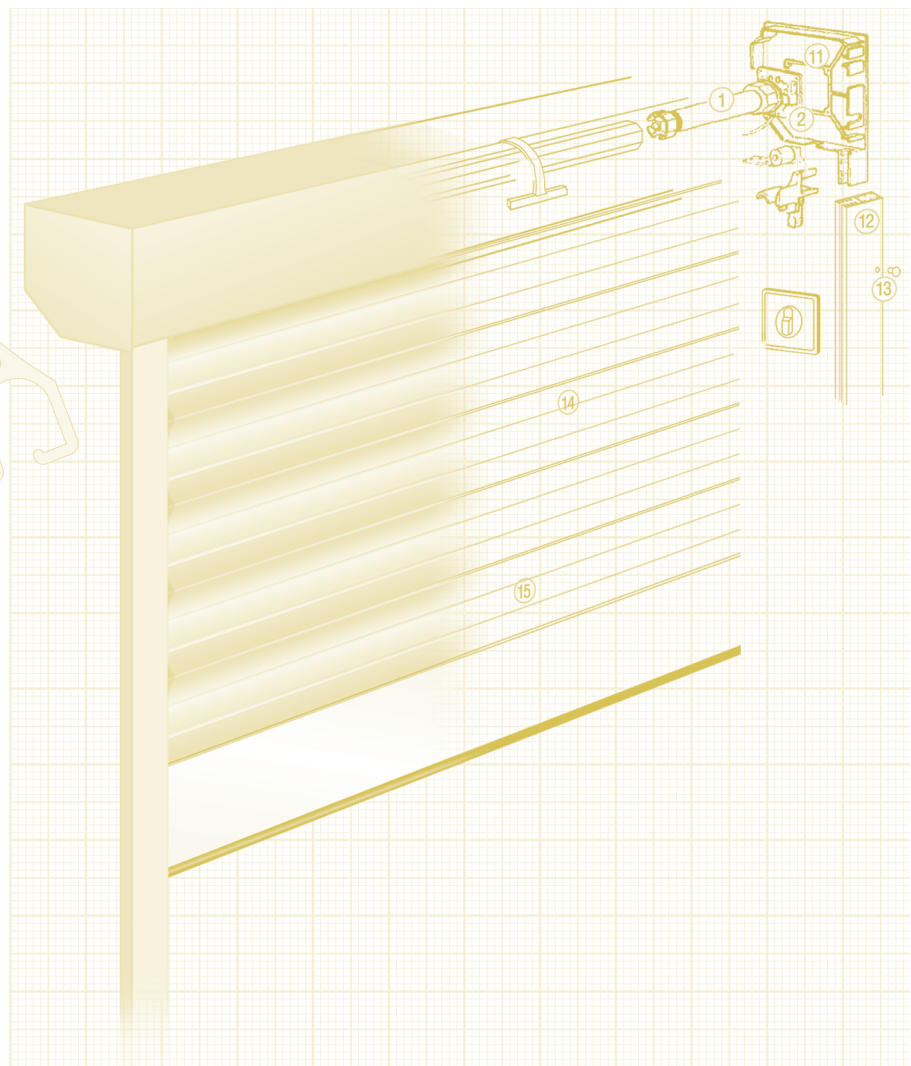

1
2
3
4
5
6
7
8
9
10
11
12
13
14
15
16
17
18
19
20
21
22
23
24
25
26
27
28
29

## KİLİTLER SECURITY BLOCKS AND LOCKS

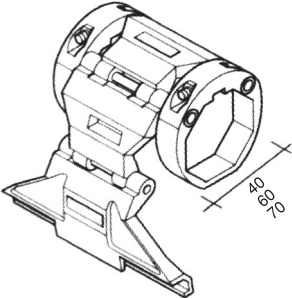
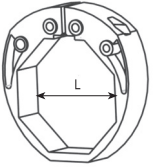
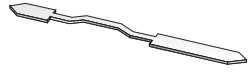
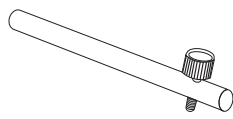
ÜRÜN İTEM	ÜRÜN ÖZELLİKLERİ PRODUCT DESCRIPTION	AMBALAJ PACKAGING	ÜRÜN KODU CODE
	<p>Blok kilit sistemi SL-39, SL-41, SL-45 için <i>Security block system for SL-39, SL-41, SL-45</i></p>	<p>25 Adet <i>25 Pieces</i></p>	LO.003.00.MIN
	<p>Blok kilit sistemi SL-55,ST-56, SE-60, SE-62, SE-63, SL-75, SL-77, SL-78, ST-77 için <i>Security block system for SL-55,ST-56, SE-60, SE-62, SE-63 SL-75, SL-77, SL-78, ST-77</i></p>	<p>25 Adet <i>25 Pieces</i></p>	LO.003.00.STA
	<p>Blok kilit sistemi için bilezik <i>Ring for block system</i></p> <p>D= 40 mm D= 60 mm D= 70 mm</p>	<p>100 Adet <i>100 Pieces</i></p>	<p>LO.040.00.RNG LO.060.00.RNG LO.070.00.RNG</p>
	<p>Sürgülü kilit, ES-440...KAP, ES-441...KAP alt parçalar için <i>Bolt lock for end slats for ES-440...KAP, ES-441...KAP</i></p>	<p>100 Adet <i>100 Pieces</i></p>	LO.000.00.BLT
	<p>Sürgülü kilit, ES-458...KAP alt parçalar için <i>Bolt lock for end slats for ES-458...KAP</i></p>	<p>100 Adet <i>100 Pieces</i></p>	LO.SCR.00.BLT

**KİLİTLER**  
**SECURITY BLOCKS AND LOCKS**

ÜRÜN ITEM	ÜRÜN ÖZELLİKLERİ PRODUCT DESCRIPTION	AMBALAJ PACKAGING	ÜRÜN KODU CODE
	Anahtarlı kilit, ES-425...GAP, ES-444...XAP alt parçalar için <i>Sliding lock for ES-425...GAP, ES-444...XAP end slats</i>	25 Adet <i>25 Pieces</i>	LO.000.00.LOC
	Alt parça kepenk kilidi <i>Central multileverlock for rolling shutter bended bars</i>	25 Adet <i>25 Pieces</i>	SKK.019.SD.9CO
	Midi alt parça uyumlu, merkezden silindir kilittli <i>Central cylinder lock - available with midi end slat</i>	25 Adet <i>25 Pieces</i>	LO.6C3.32.28K
	Klipsli kilit Tüm profiller için <i>Security block system for all slats</i>	50 Adet <i>50 Pieces</i>	LO.CLI.00.LOC



**Çelik Askılar**  
**Security Springs**

- 1
- 2
- 3
- 4
- 5
- 6
- 7
- 8
- 9
- 10
- 11
- 12
- 13
- 14
- 15
- 16
- 17
- 18
- 19
- 20
- 21
- 22
- 23
- 24
- 25
- 26
- 27
- 28
- 29

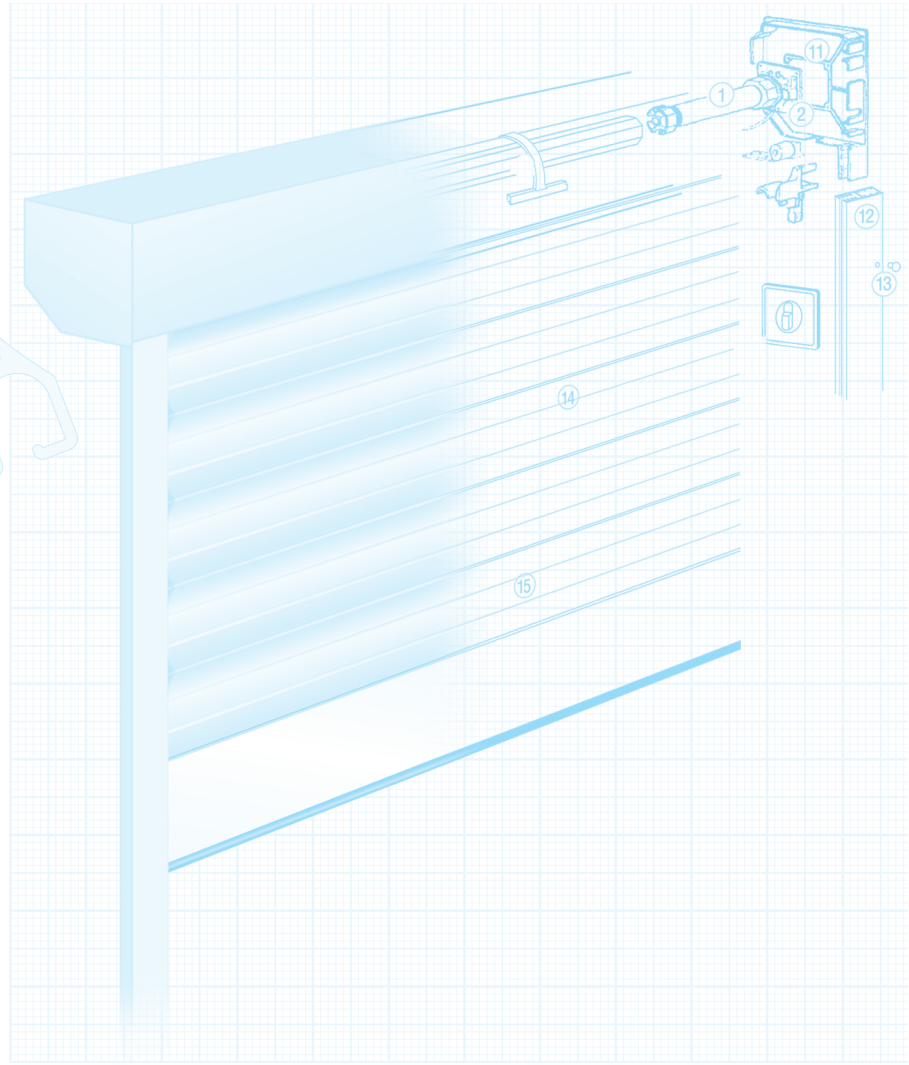

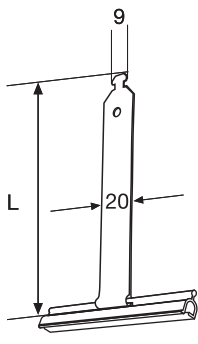
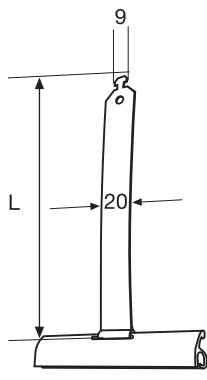
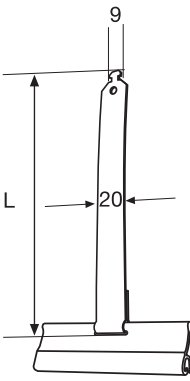

## ÇELİK ASKILAR SECURITY SPRINGS

ÜRÜN ITEM	ÜRÜN ÖZELLİKLERİ PRODUCT DESCRIPTION	AMBALAJ PACKAGING	ÜRÜN KODU CODE
	<p>130 mm Vida ile takılabilen kısmi boyalı çelik askı ( SL-39, SL-41, SL-45, SE-45) <i>security spring 130 mm for screw partly painted</i> (SL-39, SL-41, SL-45, SE-45)</p>	<p>100 Adet <i>100 Pieces</i></p>	SS.130.00.SCR
	<p>130 mm Vida ile takılabilen boyalı çelik askı (SL-39, SL-41, SL-45, SE-45) <i>security spring 130 mm for screw painted</i> (SL-39, SL-41, SL-45, SE-45)</p>	<p>100 Adet <i>100 Pieces</i></p>	SS.130.04.SCR
	<p>170 mm Vida ile takılabilen kısmi boyalı çelik askı (SL-55, SL-56, SE-62, ST-56) <i>security spring 170 mm for screw partly painted</i> (SL-55, SL-56, SE-62, ST-56)</p>	<p>100 Adet <i>100 Pieces</i></p>	SS.170.00.SCR
	<p>170 mm Vida ile takılabilen boyalı çelik askı (SL-55, SL-56, SE-62, ST-56) <i>security spring 170 mm for screw painted</i> (SL-55, SL-56, SE-62, ST-56)</p>	<p>100 Adet <i>100 Pieces</i></p>	SS.170.04.SCR
	<p>190 mm Vida ile takılabilen kısmi boyalı çelik askı (SL-77, SE-77, ST-77) <i>security spring 190 mm for screw partly painted</i> (SL-77, SE-77, ST-77)</p>	<p>100 Adet <i>100 Pieces</i></p>	SS.190.00.SCR
	<p>190 mm Vida ile takılabilen boyalı çelik askı SL-77, SE-77, ST-77 için <i>security spring 190 mm for screw painted</i> (SL-77, SE-77, ST-77)</p>	<p>100 Adet <i>100 Pieces</i></p>	SS.190.04.SCR

## ÇELİK ASKILAR SECURITY SPRINGS

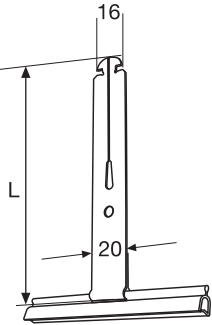
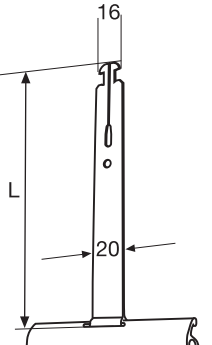
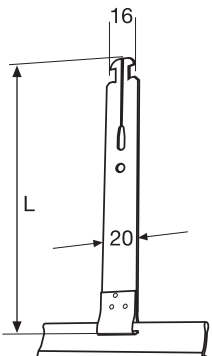
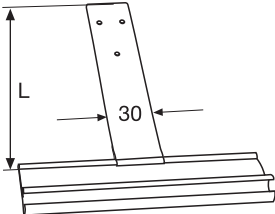
ÜRÜN İTEM	ÜRÜN ÖZELLİKLERİ PRODUCT DESCRIPTION	AMBALAJ PACKAGING	ÜRÜN KODU CODE
	<p>130 mm Yarıklı kısmi boyalı çelik askı (SL-39, SL-41, SL-45, SE-45) <i>security spring 130 mm for insert partly painted</i> (SL-39, SL-41, SL-45, SE-45)</p>	<p>100 Adet <i>100 Pieces</i></p>	SS.130.00.INS
	<p>130 mm Yarıklı boyalı çelik askı (SL-39, SL-41, SL-45, SE-45) <i>security spring 130 mm for insert painted</i> (SL-39, SL-41, SL-45, SE-45)</p>	<p>100 Adet <i>100 Pieces</i></p>	SS.130.04.INS
	<p>170 mm Yarıklı kısmi boyalı çelik askı (SL-55, SL-56, SE-62, ST-56) <i>security spring 170 mm for insert partly painted</i> (SL-55, SL-56, SE-62, ST-56)</p>	<p>100 Adet <i>100 Pieces</i></p>	SS.170.00.INS
	<p>170 mm Yarıklı boyalı çelik askı SL-55, SL-56, SE-62, ST-56 için <i>security spring 170 mm for insert painted</i> (SL-55, SL-56, SE-62, ST-56)</p>	<p>100 Adet <i>100 Pieces</i></p>	SS.170.04.INS
	<p>190 mm Yarıklı kısmi boyalı çelik askı (SL-77, SE-77, ST-77) <i>security spring 190 mm for insert partly painted</i> (SL-77, SE-77, ST-77)</p>	<p>100 Adet <i>100 Pieces</i></p>	SS.190.00.INS
	<p>190 mm Yarıklı boyalı çelik askı (SL-77, SE-77, ST-77) <i>security spring 190 mm for insert painted</i> (SL-77, SE-77, ST-77)</p>	<p>100 Adet <i>100 Pieces</i></p>	SS.190.04.INS
	<p>150 mm vida ile takılabilen kısmi boyalı çelik askı (SL-100, SL-101, ST-100 için) <i>security spring 150 mm for screw partly painted</i> (SL-100, SL-101, ST-100)</p>	<p>100 Adet <i>100 Pieces</i></p>	SS.150.00.SCR



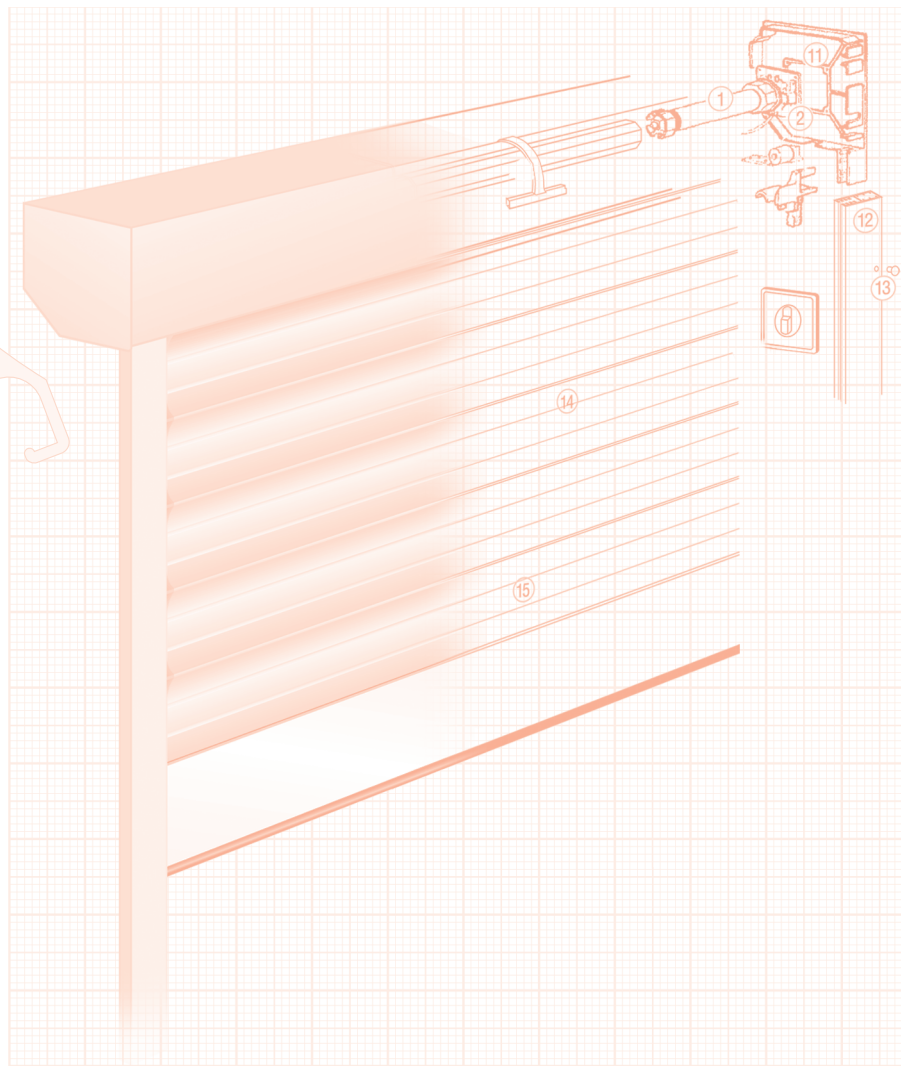

**Plastik Tapalar, Polikarbonat Camlar**  
*PVC Caps and Polycarbonate Windows*



- 1
- 2
- 3
- 4
- 5
- 6
- 7
- 8
- 9
- 10
- 11
- 12
- 13
- 14
- 15
- 16
- 17
- 18
- 19
- 20
- 21
- 22
- 23
- 24
- 25
- 26
- 27
- 28
- 29

**PLASTİK TAPALAR POLİKARBONAT CAMLAR**  
**PVC CAPS AND POLYCARBONATE WINDOWS**

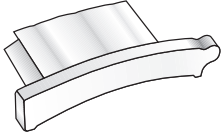
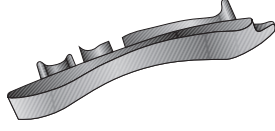
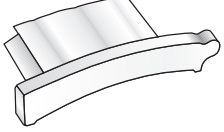
ÜRÜN İTEM	ÜRÜN ÖZELLİKLERİ PRODUCT DESCRIPTION	AMBALAJ PACKAGING	ÜRÜN KODU CODE
	Poliüretan dolgulu profil tapaları <i>PVC cap of polyurethane filled slats</i> SL-39	4000 Adet <i>4000 Pieces</i>	CA.039.00.CAP
	SL-41	2000 Adet <i>2000 Pieces</i>	CA.041.00.CAP
	SL-45	2000 Adet <i>2000 Pieces</i>	CA.045.00.CAP
	SE-45	2000 Adet <i>2000 Pieces</i>	CA.045.AL.CAP
	SL-55	1000 Adet <i>1000 Pieces</i>	CA.055.00.CAP
	SL-55 Sert Poliüretan Tapa <i>Nigh Density Cap</i>	1000 Adet <i>1000 Pieces</i>	CA.055.00.SGP
	SL-56	1000 Adet <i>1000 Pieces</i>	CA.056.00.CAP
	SL-77/SL-S77	Sağ 1000 Adet Sol 1000 Adet <i>Right 1000 Pieces</i> <i>Left 1000 Pieces</i>	CA.077.00.CAP
	ST-55	1000 Adet <i>1000 Pieces</i>	CA.055.ST.CAP
	ST-77	Sağ 1000 Adet Sol 1000 Adet <i>Right 1000 Pieces</i> <i>Left 1000 Pieces</i>	CA.077.ST.CAP
	Alüminyum ekstrüzyon profil tapaları <i>PVC cap of aluminium extruded slats</i> SE-60	2000 Adet <i>2000 Pieces</i>	CA.060.00.CAP
	SE-62	Sağ 2000 Adet Sol 2000 Adet <i>Right 2000 Pieces</i> <i>Left 2000 Pieces</i>	CA.062.00.CAP

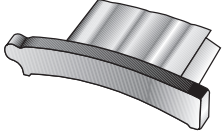
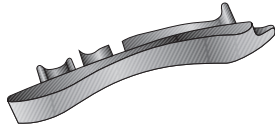
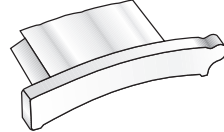
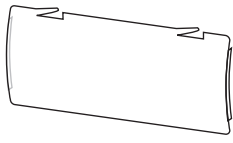
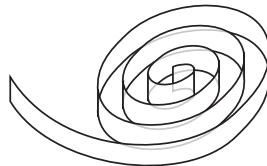
ÜRÜN ITEM	ÜRÜN ÖZELLİKLERİ PRODUCT DESCRIPTION	AMBALAJ PACKAGING	ÜRÜN KODU CODE
	SE-63	Sağ 2000 Adet Sol 2000 Adet <i>Right 2000 Pieces</i> <i>Left 2000 Pieces</i>	CA.063.00.CAP
	SE-77	Sağ 1000 Adet Sol 1000 Adet <i>Right 1000 Pieces</i> <i>Left 1000 Pieces</i>	CA.077.SE.CAP
	SE-78 / SL-78	Sağ 1000 Adet Sol 1000 Adet <i>Right 1000 Pieces</i> <i>Left 1000 Pieces</i>	CA.078.00.CAP
	SL-100 / ST 100	Sağ 1000 Adet Sol 1000 Adet <i>Right 1000 Pieces</i> <i>Left 1000 Pieces</i>	CA.100.ST.CAP
	SL-101	Sağ 1000 Adet Sol 1000 Adet <i>Right 1000 Pieces</i> <i>Left 1000 Pieces</i>	CA.101.ST.CAP
	SE-100	Sağ 1000 Adet Sol 1000 Adet <i>Right 1000 Pieces</i> <i>Left 1000 Pieces</i>	CA.100.00.CAP
	SE-101	Sağ 1000 Adet Sol 1000 Adet <i>Right 1000 Pieces</i> <i>Left 1000 Pieces</i>	CA.101.00.CAP
	SE-78, SL-78 & SE-101 pencere li profiller için polikarbonat cam <i>Polycarbonate window glass</i> <i>For SE-78, SL-78 &amp; SE-101</i> <i>slats with window</i>	1000 Adet <i>1000 Pieces</i>	CA.WIN.00.GLA
	SE-63 pencere li profiller için polikarbonat şerit cam <i>Polycarbonate window glass band</i> <i>For SE-63 slats with window</i>	250 Metre <i>250 Meter</i>	CA.WIN.01.GLA
	SE-78, SL-78 & SE-101 pencere li profiller için polikarbonat şerit cam <i>Polycarbonate window glass band</i> <i>For SE-78, SL-78 &amp; SE-101</i> <i>slats with window</i>	500 Metre <i>500 Meter</i>	CA.WIN.02.GLA
	SE-101 pencere li profiller için polikarbonat şerit cam <i>Polycarbonate window glass band</i> <i>For SE-101</i>	500 Metre <i>500 Meter</i>	CA.WIN.04.GLA



## Kıl Fitiller

### *Insert*

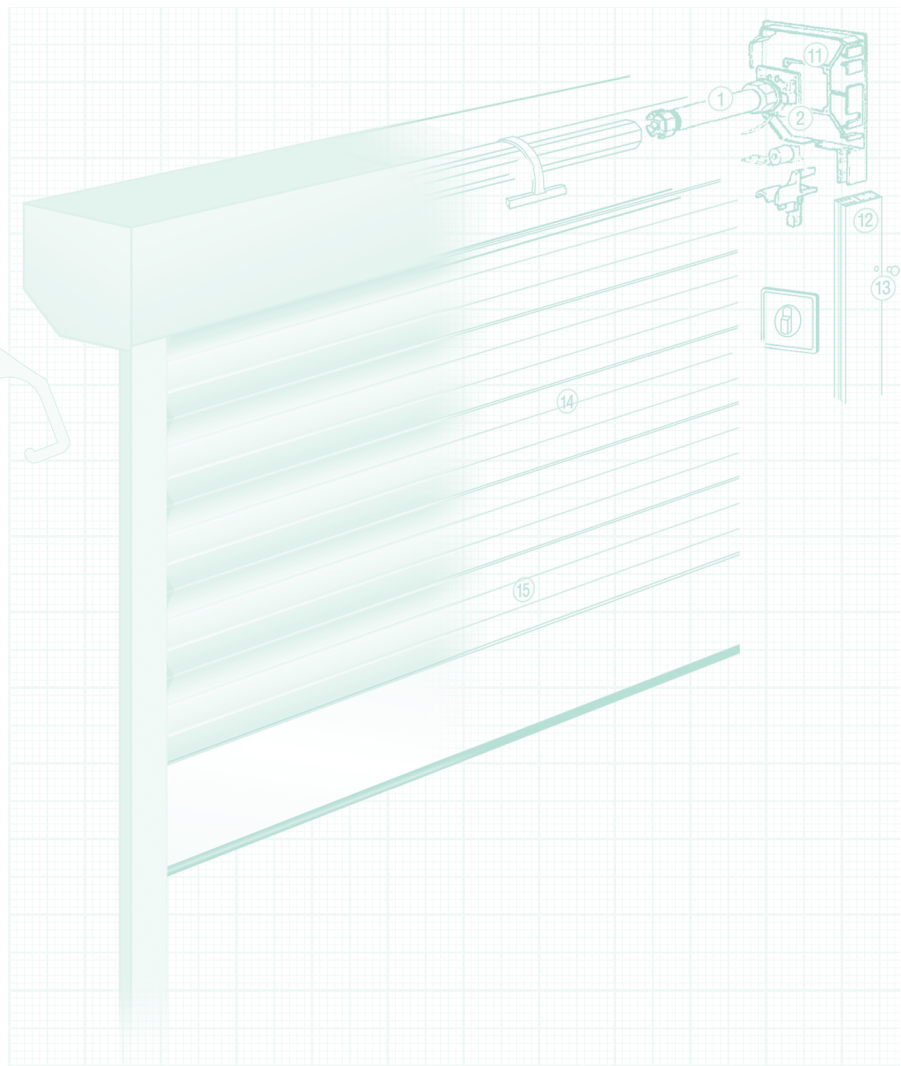

- 1
- 2
- 3
- 4
- 5
- 6
- 7
- 8
- 9
- 10
- 11
- 12
- 13
- 14
- 15
- 16
- 17
- 18
- 19
- 20
- 21
- 22
- 23
- 24
- 25
- 26
- 27
- 28
- 29

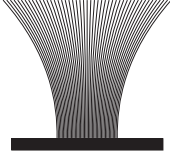
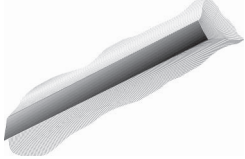

## KIL FITİLLER INSERT BRUSH

ÜRÜN ITEM	ÜRÜN ÖZELLİKLERİ PRODUCT DESCRIPTION	RENK COLOR	ÜRÜN KODU CODE	
               	48 X 450 Silikonlu kıl fitil <i>48 x 450 Siliconised insert brush</i>	Byaz <i>White</i> Gri <i>Grey</i> Kahve <i>Brown</i>	GC.045.48.INS	
	<b>AMBALAJ</b>	bir top 400 metre x 4 = 1 kolil		
	<b>PACKAGING</b>	<i>roll of 400 meter x 4 = 1 package</i>		
	48 X 450 Silikonlu kıl fitil <i>48 x 450 Siliconised insert brush</i>	Byaz <i>White</i> Gri <i>Grey</i> Kahve <i>Brown</i>	GC.055.48.INS	
	<b>AMBALAJ</b>	bir top 375 metre x 4 = 1 kolil		
	<b>PACKAGING</b>	<i>roll of 375 meter x 4 = 1 package</i>		
	48 X 450 Silikonlu kıl fitil <i>48 x 450 Siliconised insert brush</i>	Byaz <i>White</i> Gri <i>Grey</i> Kahve <i>Brown</i>	GC.080.48.INS	
	<b>AMBALAJ</b>	bir top 300 metre x 4 = 1 kolil		
	<b>PACKAGING</b>	<i>roll of 300 meter x 4 = 1 package</i>		
	67 x 550 Silikonlu kıl fitil <i>67 x 550 Siliconised insert brush</i>	Beyaz <i>White</i> Gri <i>Grey</i> Kahve <i>Brown</i>	GC.055.00.INS	
	<b>AMBALAJ</b>	bir top 400 metre x 4 = 1 koli		
	<b>PACKAGING</b>	<i>roll of 400 meter x 4 = 1 package</i>		
	67 x 600 Silikonlu kıl fitil <i>67 x 600 Siliconised insert brush</i>	Beyaz <i>White</i> Gri <i>Grey</i> Kahve <i>Brown</i>	GC.060.00.INS	
	<b>AMBALAJ</b>	bir top 375 metre x 4 = 1 koli		
	<b>PACKAGING</b>	<i>roll of 375 meter x 4 = 1 package</i>		
	67 x 800 Silikonlu kıl fitil <i>67 x 800 Siliconised insert brush</i>	Beyaz <i>White</i> Gri <i>Grey</i> Kahve <i>Brown</i>	GC.080.00.INS	
	<b>AMBALAJ</b>	bir top 300 metre x 4 = 1 koli		
	<b>PACKAGING</b>	<i>roll of 300 meter x 4 = 1 package</i>		
67 x 1200 Silikonlu kıl fitil <i>67 x 1200 Siliconised insert brush</i>	Beyaz <i>White</i> Gri <i>Grey</i> Kahve <i>Brown</i>	GC.120.00.INS		
<b>AMBALAJ</b>	bir top 200 metre x 4 = 1 koli			
<b>PACKAGING</b>	<i>roll of 200 meter x 4 = 1 package</i>			
67 x 1800 Silikonlu kıl fitil <i>67 x 1800 Siliconised insert brush</i>	Gri <i>Grey</i>	GC.180.00.INS		
<b>AMBALAJ</b>	bir top 100 metre x 4 = 1 koli			
<b>PACKAGING</b>	<i>roll of 100 meter x 4 = 1 package</i>			



**Kasnaklar**

***Pulleys***

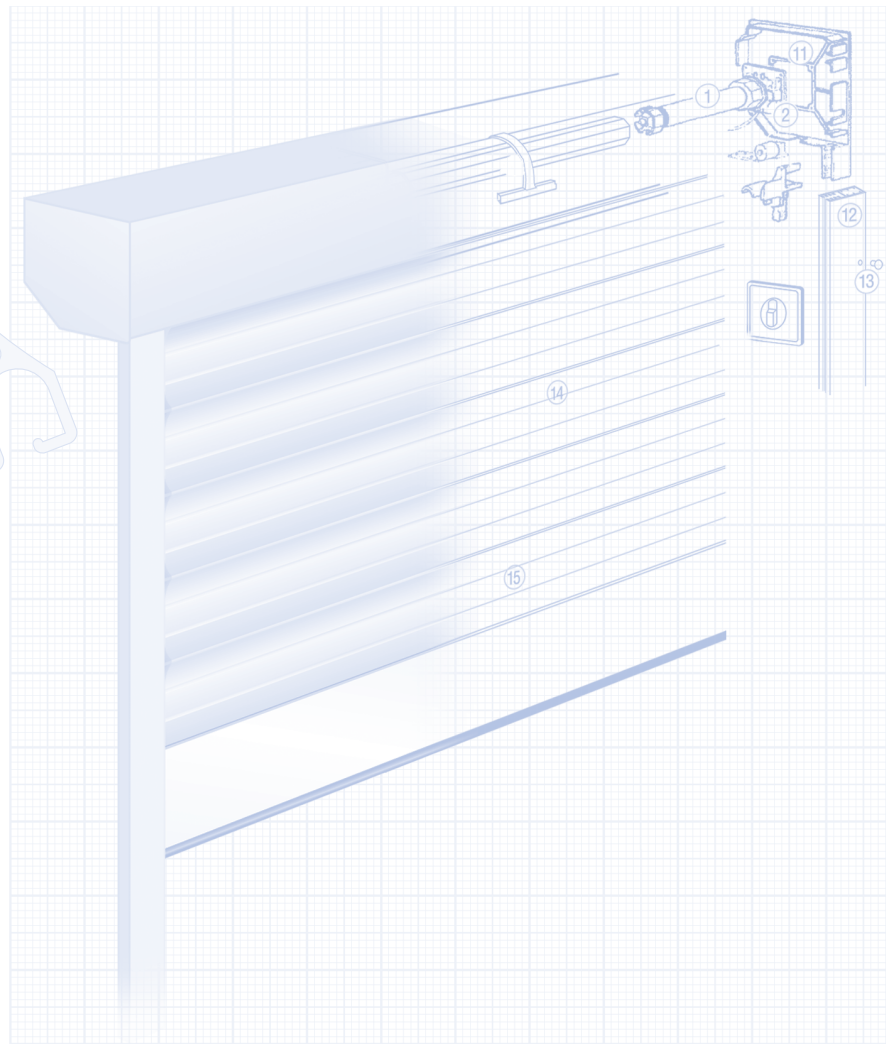

- 1
- 2
- 3
- 4
- 5
- 6
- 7
- 8
- 9
- 10
- 11
- 12
- 13
- 14
- 15
- 16
- 17
- 18
- 19
- 20
- 21
- 22
- 23
- 24
- 25
- 26
- 27
- 28
- 29

## KASNAKLAR PULLEYS

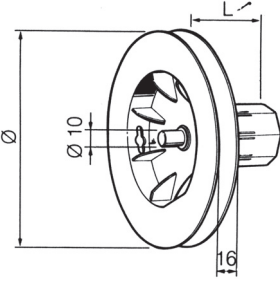
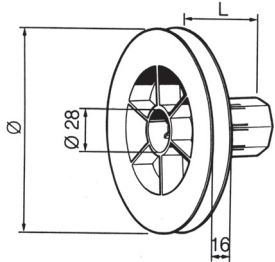
ÜRÜN ITEM	ÜRÜN ÖZELLİKLERİ PRODUCT DESCRIPTION	AMBALAJ PACKAGING	ÜRÜN KODU CODE
	40 mm boru için <i>for 40 mm tube</i>  pimli <i>with pivot</i>		
	10 mm D=115	100 Adet <i>100 Pieces</i>	PU.115.00.P40
	10 mm D=125	100 Adet <i>100 Pieces</i>	PU.125.00.P40
	10 mm D=140	100 Adet <i>100 Pieces</i>	PU.140.00.P40
	rulman yuvalı <i>for ball bearing</i>		
	D=115	100 Adet <i>100 Pieces</i>	PU.115.00.B40
	D=125	100 Adet <i>100 Pieces</i>	PU.125.00.B40
	D=140	100 Adet <i>100 Pieces</i>	PU.140.00.B40
	D=155	50 Adet <i>50 Pieces</i>	PU.155.00.B40
	D=170	50 Adet <i>50 Pieces</i>	PU.170.00.B40

## KASNAKLAR PULLEYS

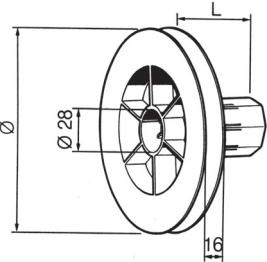
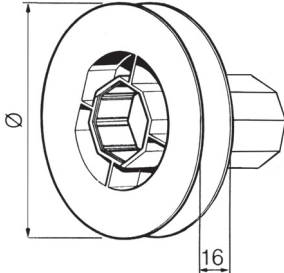
ÜRÜN ITEM	ÜRÜN ÖZELLİKLERİ PRODUCT DESCRIPTION	AMBALAJ PACKAGING	ÜRÜN KODU CODE
	<p>60 mm boru için <i>for 60 mm tube</i> rulman yuvalı <i>for ball bearing</i></p>		
	D=115	100 Adet <i>100 Pieces</i>	PU.115.00.B60
	D=125	100 Adet <i>100 Pieces</i>	PU.125.00.B60
	D=140	100 Adet <i>100 Pieces</i>	PU.140.00.B60
	D=155	50 Adet <i>50 Pieces</i>	PU.155.00.B60
	<p>Kasnak D=155 mm Çap, 40 mm boru uyumlu, 18 mm kordon uyumlu  <i>Pulley D=155 mm dia, appropriate to 40 mm tube, 18 mm strap</i></p>	100 Adet <i>100 Pieces</i>	PU.155.LB.B40



**Rulmanlar**  
***Roller Bearings***

1
2
3
4
5
6
7
8
9
10
11
12
13
14
15
16
17
18
19
20
21
22
23
24
25
26
27
28
29

## RULMANLAR ROLLER BEARINGS

ÜRÜN ITEM	ÜRÜN ÖZELLİKLERİ PRODUCT DESCRIPTION	AMBALAJ PACKAGING	ÜRÜN KODU CODE
	28 mm. mini çelik rulman <i>Ball bearing steel bushing 28 mm.</i>  d=12 mm, D=28 mm	100 Adet <i>100 Pieces</i>	RB.028.00.S12
	42 mm. çelik rulman <i>Ball bearing steel bushing 42 mm.</i>  d=12 mm, D=42 mm	100 Adet <i>100 Pieces</i>	RB.042.00.S12
	Plakalı rulman <i>Bearing with plate</i>  d=20 mm, D=102 mm tube d=30 mm, D=133 mm tube d=35 mm, D=159 mm tube	10 Adet <i>10 Pieces</i>	RB.102.00.P20 RB.133.00.P30 RB.159.00.P35





**Redüktörler**  
**Gears**

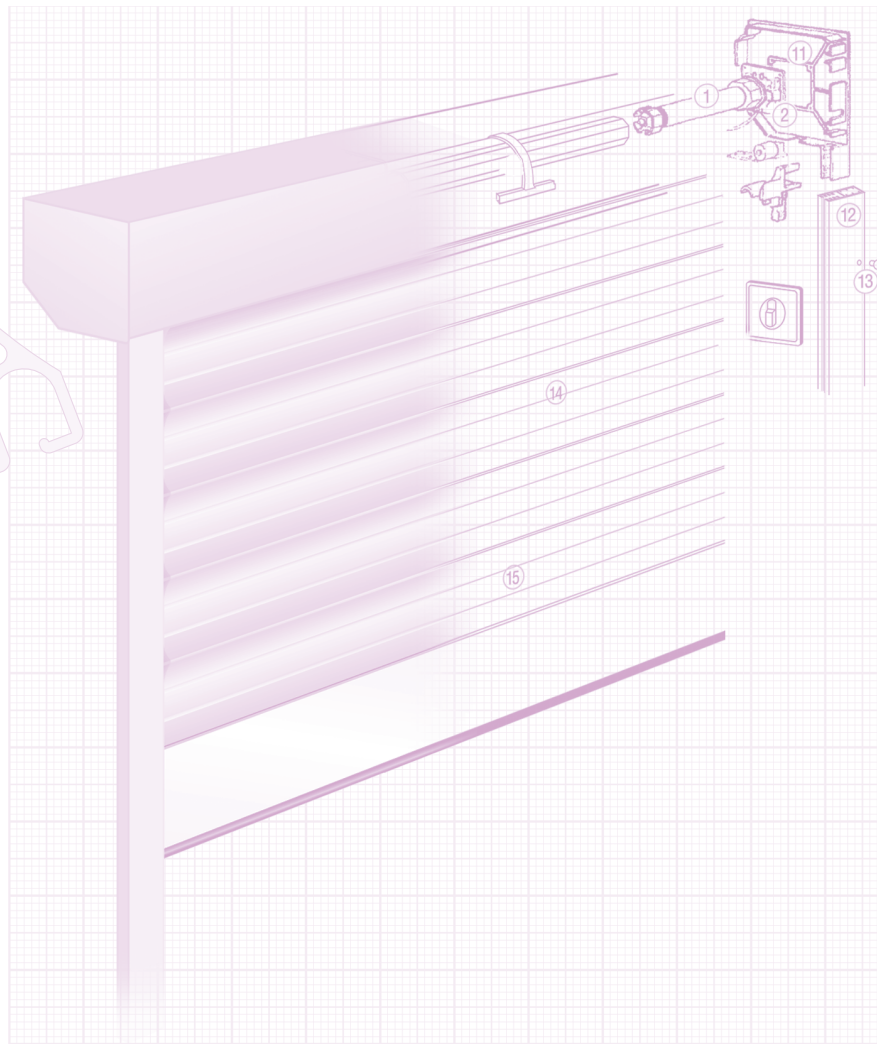

1
2
3
4
5
6
7
8
9
10
11
12
13
14
15
16
17
18
19
20
21
22
23
24
25
26
27
28
29

## REDÜKTÖRLER GEARS

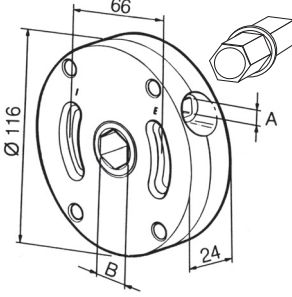
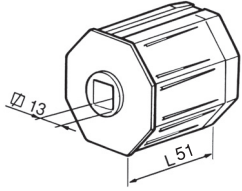
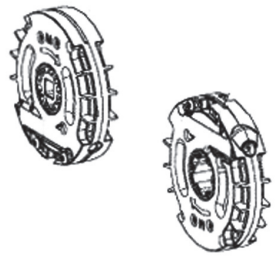
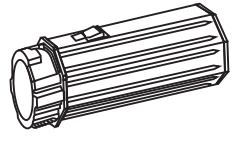
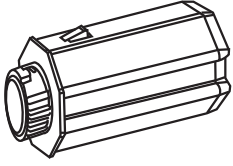
ÜRÜN ITEM	ÜRÜN ÖZELLİKLERİ PRODUCT DESCRIPTION	AMBALAJ PACKAGING	ÜRÜN KODU CODE
	<p>Pançur redüktörü, 30kg <i>Gear, rollershutter 30 kg</i></p>	<p>20 Adet <i>20 Pieces</i></p>	<p>GE.100.00.R30</p>
	<p>Aluminyum boru başı 60 mm Kare delik 13 mm L=51 mm <i>Aluminium cap 60 mm tube Square hole 13 mm L=51 mm</i></p>	<p>100 Adet <i>100 Pieces</i></p>	<p>CP.060.00.AHO</p>
	<p>Pançur redüktörü 1:5,25 Limitli <i>Gear, rollershutter 1:5,25 Limited</i></p>	<p>100 Adet <i>100 Pieces</i></p>	<p>ZF.000.0C.371</p>
	<p>Redüktör boru başı 40 mm ZF.000.0C.371 uyumlu <i>Rollershutter tube cap compatible with 40 mm ZF.000.0C.371</i></p>	<p>100 Adet <i>100 Pieces</i></p>	<p>ZF.000.A4.37B</p>
	<p>Redüktör boru başı 60 mm ZF.000.0C.371 uyumlu <i>Rollershutter tube cap compatible with 60 mm ZF.000.0C.371</i></p>	<p>100 Adet <i>100 Pieces</i></p>	<p>ZF.000.A4.83B</p>

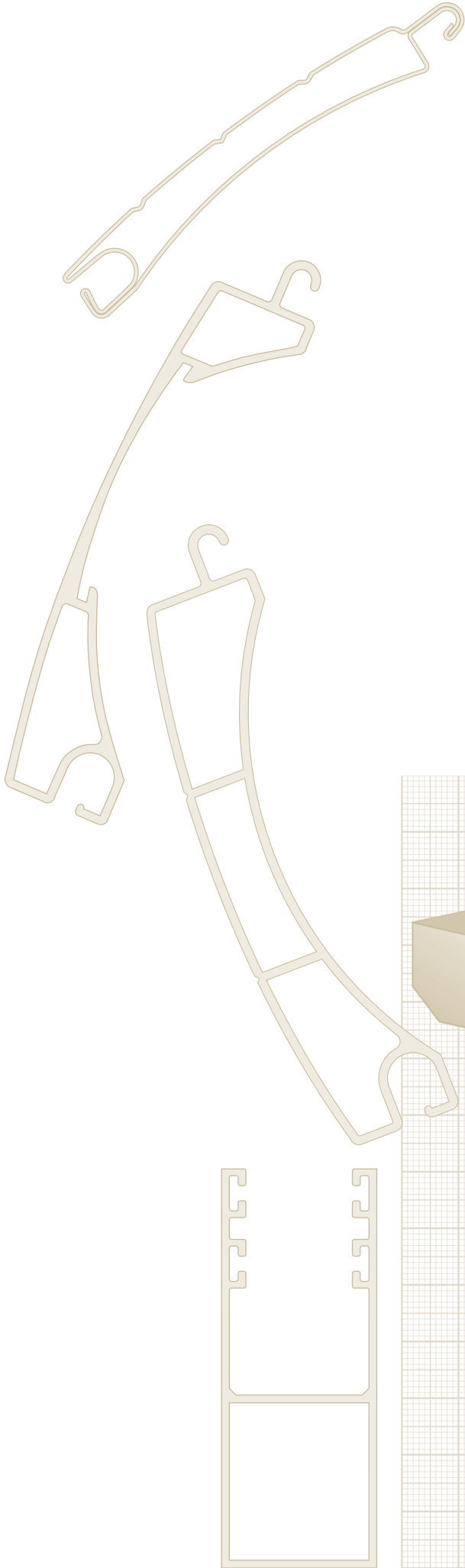

## Redüktör Kolları ve Ara Kolları

### *Handcranks and Joints*

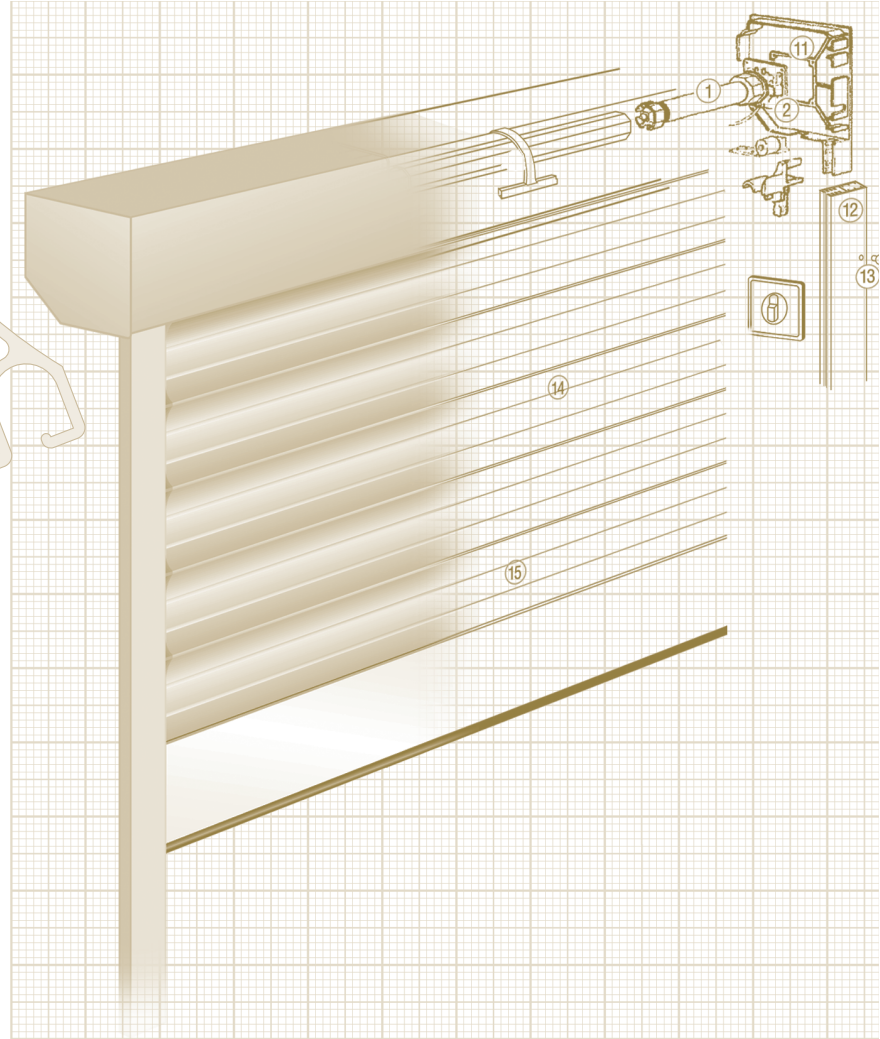

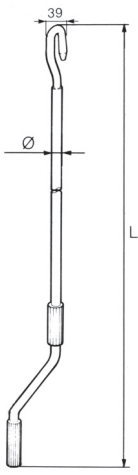
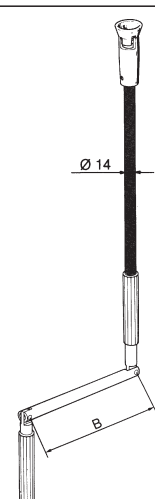
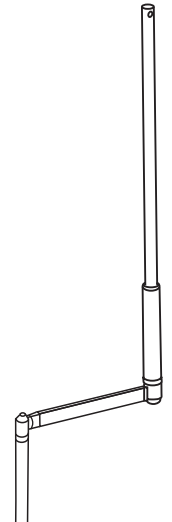

- 1
- 2
- 3
- 4
- 5
- 6
- 7
- 8
- 9
- 10
- 11
- 12
- 13
- 14
- 15
- 16
- 17
- 18
- 19
- 20
- 21
- 22
- 23
- 24
- 25
- 26
- 27
- 28
- 29

## REDÜKTÖR KOLLARI VE ARA KOLLARI HANDCRANKS AND JOINTS

ÜRÜN ITEM	ÜRÜN ÖZELLİKLERİ PRODUCT DESCRIPTION	AMBALAJ PACKAGING	ÜRÜN KODU CODE
	Kancalı redüktör çevirme kolu (Beyaz) <i>Handcrank with hook (White)</i>		
	L=1500	25 Adet <i>25 Pieces</i>	HJ.150.00.HCH
	L=1800	25 Adet <i>25 Pieces</i>	HJ.180.00.HCH
	L=2000	25 Adet <i>25 Pieces</i>	HJ.200.00.HCH
	L=2400	25 Adet <i>25 Pieces</i>	HJ.240.00.HCH
	Konik kafalı (kūlahlı) redüktör çevirme kolu <i>Handcrank with cone head</i>	25 Adet <i>25 Pieces</i>	HJ.180.00.HCC
	Çevirme kolu 1100 mm ZF.00N.78.5NG uyumlu <i>Handcrank 1100 mm compatible with ZF.00N.78.5NG</i>	25 Adet <i>25 Pieces</i>	ZF.000.E6.05A
	Çevirme kolu 1200 mm ZF.00N.78.5NG uyumlu <i>Handcrank 1200 mm compatible with ZF.00N.78.5NG</i>	25 Adet <i>25 Pieces</i>	ZF.000.E6.11A

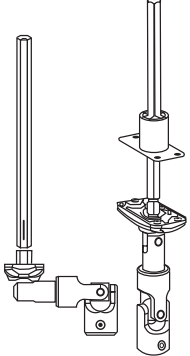
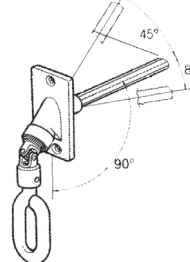
## REDÜKTÖR KOLLARI VE ARA KOLLARI HANDCRANKS AND JOINTS

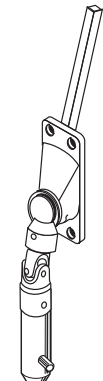
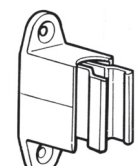
ÜRÜN İTEM	ÜRÜN ÖZELLİKLERİ PRODUCT DESCRIPTION	AMBALAJ PACKAGING	ÜRÜN KODU CODE
	Ara kol ZF.000.0C.371 uyumlu <i>Joint compatible with ZF.000.0C.371</i>	25 Adet <i>25 Pieces</i>	ZF.00N.78.5NG
	Kancalı redüktör ara kumanda kolu <i>Joint with eye octagonal</i>	60 Adet <i>60 Pieces</i>	HJ.008.00.J90
	Basit redüktör ara kumanda kolu HJ.000.00.PIN, HJ.180.00.HCS uyumlu <i>Joint simple octagonal. For HJ.000.00.PIN, HJ.180.00.HCS</i>	60 Adet <i>60 Pieces</i>	HJ.008.00.J70
	Külahlı ara kumanda kolu HJ-18 .... kol uyumlu <i>Intermediate control lever with cone head for HJ-180....</i>	20 Adet <i>20 Pieces</i>	HJ.008.AE.J70
	Redüktör kolu duvar tutacağı <i>Adjustable handle lock</i>	100 Adet <i>100 Pieces</i>	HJ.000.00.AHL

## Otomatik Makaralar

### Strap Boxes

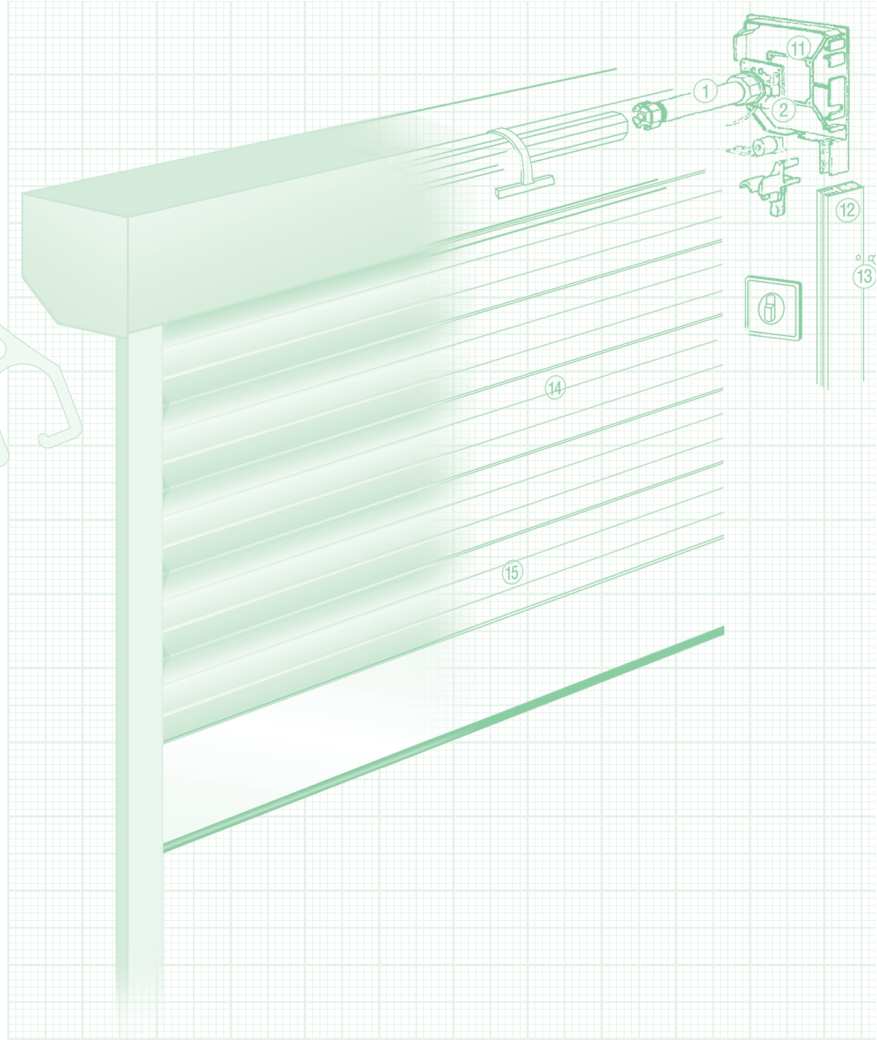



- 1
- 2
- 3
- 4
- 5
- 6
- 7
- 8
- 9
- 10
- 11
- 12
- 13
- 14
- 15
- 16
- 17
- 18
- 19
- 20
- 21
- 22
- 23
- 24
- 25
- 26
- 27
- 28
- 29

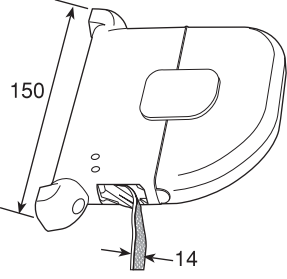
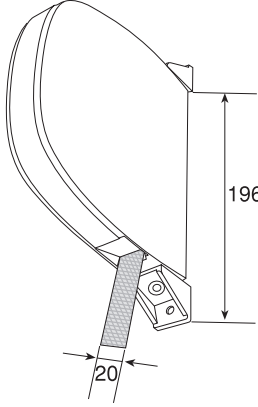
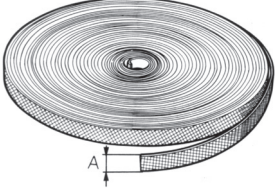

## OTOMATİK MAKARALAR STRAP BOXES

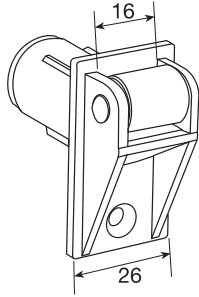
ÜRÜN ITEM	ÜRÜN ÖZELLİKLERİ PRODUCT DESCRIPTION	AMBALAJ PACKAGING	RENK COLOR	ÜRÜN KODU CODE
	Sıvaüstü 150 mm <i>Strap box 150 mm on wall</i>	25 Adet <i>25 Pieces</i>	Beyaz <i>White</i> Kahve <i>Brown</i> Diğer renkler <i>Other colors</i>	SB.150.01.OUT SB.150.03.OUT SB.150.RA.OUT
	Sıvaüstü 196 mm <i>Strap box 196 mm on wall</i>	25 Adet <i>25 Pieces</i>	Beyaz <i>White</i>	SB.196.01.OUT
	Kordon <i>Strap</i> A=14 mm	50 Metre <i>50 Meter</i>	Beyaz <i>White</i> Kahve <i>Brown</i> Diğer renkler <i>Other colors</i>	CO.014.01.STR CO.014.03.STR CO.014.RA.STR
	Kordon <i>Strap</i> A=16 mm	50 Metre <i>50 Meter</i>	Beyaz <i>White</i> Kahve <i>Brown</i> Diğer renkler <i>Other colors</i>	CO.016.01.STR CO.016.03.STR CO.016.RA.STR
	Kordon <i>Strap</i> A=18 mm	50 Metre <i>50 Meter</i>	Beyaz <i>White</i> Kahve <i>Brown</i> Diğer renkler <i>Other colors</i>	CO.018.01.STR CO.018.03.STR CO.018.RA.STR
	Kordon <i>Strap</i> A=20 mm	50 Metre <i>50 Meter</i>	Beyaz <i>White</i> Kahve <i>Brown</i> Diğer renkler <i>Other colors</i>	CO.020.01.STR CO.020.03.STR CO.020.RA.STR

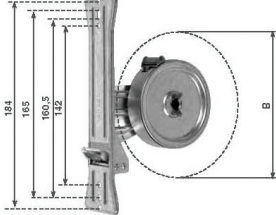
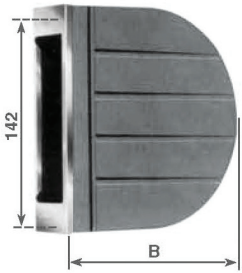
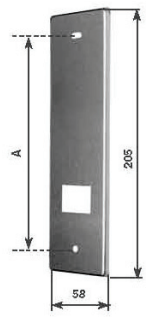
ÜRÜN ITEM	ÜRÜN ÖZELLİKLERİ PRODUCT DESCRIPTION	AMBALAJ PACKAGING	RENK COLOR	ÜRÜN KODU CODE
	20 mm Kordon geçme klavuzu <i>Tubular strap guide</i>	25 Adet <i>25 Pieces</i>	Beyaz Kahve <i>White Brown</i>	HJ.020.01.TSG HJ.020.03.TSG
	14 mm Kordon geçme klavuzu <i>Tubular strap guide</i>	25 Adet <i>25 Pieces</i>	Beyaz Kahve <i>White Brown</i>	HJ.014.01.TSG HJ.014.03.TSG
	14 mm Kordon geçme makarası çift silindirli, sac <i>Strap guide, double roller galvanised steel</i>	100 Adet <i>100 Pieces</i>	Beyaz Kahve <i>White Brown</i>	SB.KOR.01.DEM SB.KOR.03.DEM
	14 mm Kordon geçme makarası fırçalı, naylon <i>Strap guide, nylon roll with brush</i>	100 Adet <i>100 Pieces</i>	Beyaz Kahve <i>White Brown</i>	SB.KOR.01.MAK SB.KOR.03.MAK
	14 mm PVC pencere kordon geçiş yüksüğü <i>Spacer for rope guide at PVC windows</i>	250 Adet <i>250 Pieces</i>	Beyaz Kahve Diğer renkler <i>White Brown Other color</i>	SB.KOR.01.PVC SB.KOR.03.PVC SB.KOR.RA.PVC

ÜRÜN ITEM	ÜRÜN ÖZELLİKLERİ PRODUCT DESCRIPTION	AMBALAJ PACKAGING	RENK COLOR	ÜRÜN KODU CODE
	<p>SıvaAltı İthal Gömme Otomatik Makara</p> <p><i>Built in strap coiler</i></p>	<p>25 Adet 25 Pieces</p>		SB.196.00.INS
	<p>Sıva Altı İthal Gömme Otomatik Makara Kutusu- PVC</p> <p><i>Plastic box</i></p>	<p>25 Adet 25 Pieces</p>		SB.196.00.COR
	<p>Sıva Altı İthal Gömme Otomatik Makara Kutu Kapağı,</p> <p><i>Cover plate for Built in strap coiler</i></p>	<p>100 Adet 100 Pieces</p>	<p>İnox Paslanmaz <i>Inox Stainless</i> Parlak <i>Glossy</i> Beyaz <i>White</i> Kahve (özel) <i>Brown (special)</i> Bronz (özel) <i>Bronze (special)</i></p>	<p>SB.196.00.COV SB.196.01.COV SB.196.03.COV SB.196.07.COV</p>
	<p>Galvaniz Kasnak Çap: 16 cm</p> <p><i>Steel pulley dia: 16 cm</i></p>	<p>50 ADET 50 ADET</p>		PU.049.N1.620





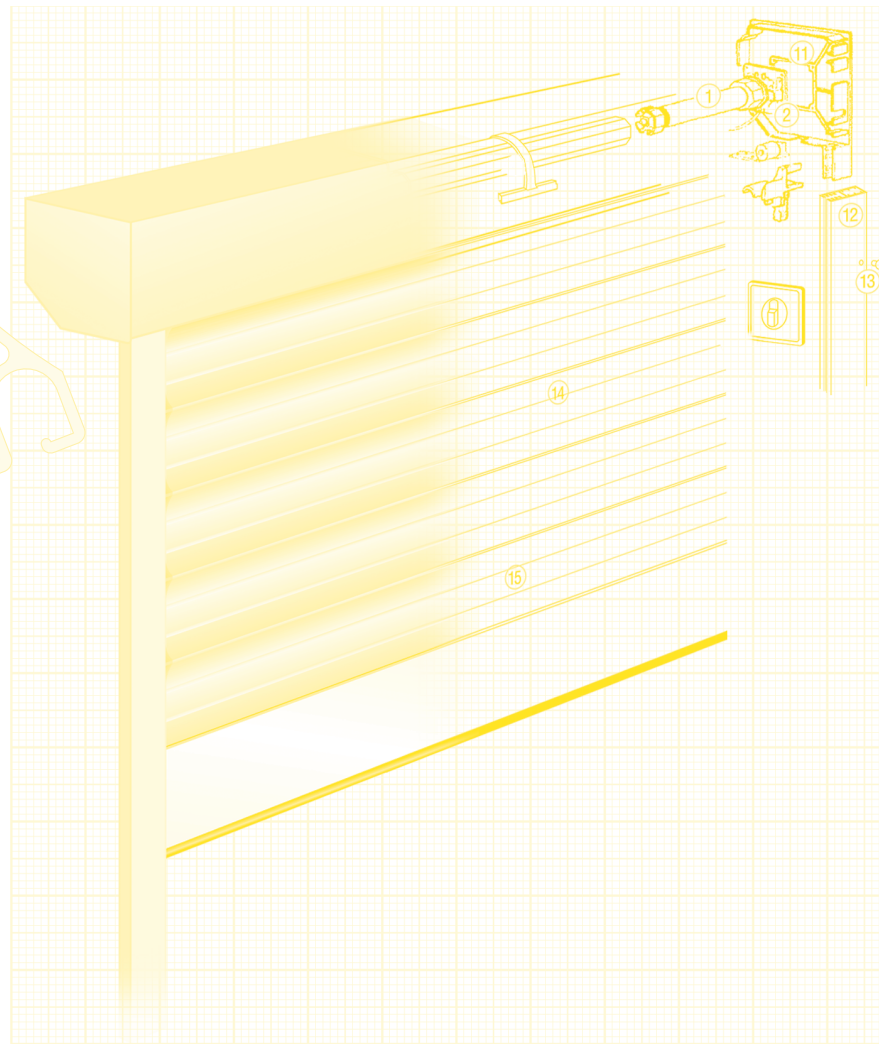

**Motor Kontrol Anahtarları**  
*Motor Switches Control Systems*





- 1
- 2
- 3
- 4
- 5
- 6
- 7
- 8
- 9
- 10
- 11
- 12
- 13
- 14
- 15
- 16
- 17
- 18
- 19
- 20
- 21
- 22
- 23
- 24
- 25
- 26
- 27
- 28
- 29

**MOTOR KONTROL ANAHTARLARI**  
**MOTOR SWITCHES CONTROL SYSTEMS**

ÜRÜN ITEM	ÜRÜN ÖZELLİKLERİ PRODUCT DESCRIPTION	ÜRÜN KODU CODE
	Sıva Altı Çevirmeli Kalıcı Buton <i>Flush (in) rotary switch two way maintained</i>	SW.ROT.01.IMA
	Sıva Altı Çevirmeli Kayırıcı (yaylı) Buton <i>Flush (in) rotary switch momentary</i>	SW.ROT.01.IMO
	Tek Butonlu, İki Yönlü (Sıva Altı) <i>One switch, has two controlling sides Flush (in)</i>	SW.PBS.00.KRM
	Tek Butonlu, İki Yönlü (Sıva Üstü) <i>One switch, has two controlling sides Surface (on)</i>	SW.PBS.00.CNY
	Sıva Üstü Çevirmeli Kalıcı Buton <i>Surface (on) rotary switch maintained</i>	SW.ROT.01.OMA
	Sıva Üstü Çevirmeli Kayırıcı (yaylı) Buton <i>Surface (on) rotary switch momentary</i>	SW.ROT.01.OMO

**MOTOR KONTROL ANAHTARLARI**  
**MOTOR SWITCHES CONTROL SYSTEMS**

<b>ÜRÜN ITEM</b>	<b>ÜRÜN ÖZELLİKLERİ PRODUCT DESCRIPTION</b>	<b>ÜRÜN KODU CODE</b>
	Sıva altı iki yönlü basmalı, kalıcılı tek buton <i>Flush in two way switch maintained</i>	SW.PBS.01.CMA
	Sıva üstü iki yönlü basmalı, kalıcılı tek buton <i>Flush on two way switch maintained</i>	SW.PBS.00.CMA
	Sıva Altı Anahtarlı Kalıcı Şalter <i>Flush (in) key switch maintained</i>	SW.KEY.00.IMA
	Sıva Altı Anahtarlı Kayırıcı (yaylı) Şalter <i>Flush (in) key switch momentary</i>	SW.KEY.00.IMO
	Sıva Üstü Anahtarlı Kalıcı Şalter <i>Surface (on) key switch maintained</i>	SW.KEY.00.OMA
	Sıva Üstü Anahtarlı Kayırıcı (yaylı) Şalter <i>Surface (on) key switch momentary</i>	SW.KEY.00.OMO



## Uzaktan Kumanda Sistemleri



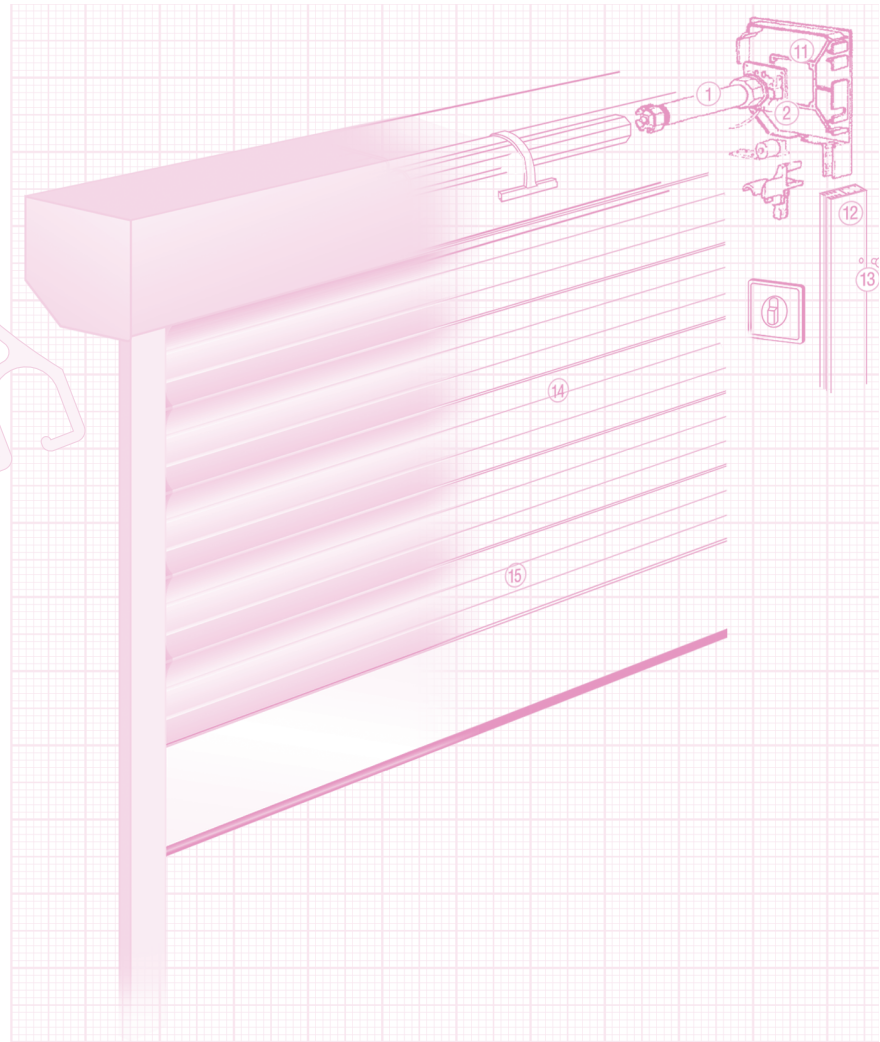

### *Remote Control Systems*







- 1
- 2
- 3
- 4
- 5
- 6
- 7
- 8
- 9
- 10
- 11
- 12
- 13
- 14
- 15
- 16
- 17
- 18
- 19
- 20
- 21
- 22
- 23
- 24
- 25
- 26
- 27
- 28
- 29



*Comfortline* **UZAKTAN KUMANDA SİSTEMLERİ**  
**HOME REMOTE CONTROL SYSTEMS**

ITEM ÜRÜN	PRODUCT DESCRIPTION ÜRÜN ÖZELLİKLERİ	CODE ÜRÜN KODU
	Comfortline Alıcı (Panjur kutusu içine monte edilebilir, buton bağlanabilir, 433 MHz )  <i>Comfortline Radio Receiver</i> (It can be assembled into rolling shutter box, switch can be mounted, 433 MHz)	RC.RAP.00.POW
	Comfortline Tek kanallı verici <i>1 Channel Transmitter</i>	RC.PRO.00.01C
	Comfortline 5+1 kanallı verici <i>5+1 Channel Transmitter</i>	RC.PRO.00.06C
	Comfortline 11+1 kanallı verici <i>11+1 Channel Transmitter</i>	RC.PRO.00.12C

*Comfortline* UZAKTAN KUMANDA SİSTEMLERİ  
REMOTE CONTROL SYSTEMS

ITEM ÜRÜN	PRODUCT DESCRIPTION ÜRÜN ÖZELLİKLERİ	CODE ÜRÜN KODU
	Comfortline Venus Plus Radyo Alıcı (Fotosel uyumlu) <i>Comfortline Venus Plus Radio Receiver for photocell</i>	RC.VEN.01.PLU
	Fotosel <i>Photocell</i>	RC.PHO.00.000
	Bir kanallı verici <i>1 Channel Transmitter</i>	RC.TRA.GW.01C
	İki kanallı verici <i>2 Channel Transmitter</i>	RC.TRA.GW.02C
	Dört kanallı verici <i>4 Channel Transmitter</i>	RC.TRA.GW.04C





# CORVUS

## UZAKTAN KUMANDA SİSTEMLERİ REMOTE CONTROL SYSTEMS

ITEM ÜRÜN	PRODUCT DESCRIPTION ÜRÜN ÖZELLİKLERİ	CODE ÜRÜN KODU
	Corvus Power Radyo Alıcı (Panjur kutusu içine monte edilebilir, buton bağlanabilir, 433 MHz ) <i>Corvus Power Radio Receiver</i> (It can be assembled into rolling shutter box, switch can be mounted, 433 MHz)	RC.COR.00.ALC
	İki kanallı verici <i>2 Channel Transmitter</i>	RC.COR.00.02C
	Dört kanallı verici <i>4 Channel Transmitter</i>	RC.COR.00.04C
	Çok kanallı verici <i>Multi Channel Transmitter</i>	RC.COR.01.00C

## EMNİYET KUMANDA SİSTEMLERİ SAFETY REMOTE SYSTEMS



ÜRÜN ITEM	ÜRÜN ÖZELLİKLERİ PRODUCT DESCRIPTION	RENK COLOR	ÜRÜN KODU CODE
	MO715- buton-fotosel-pnömatik emniyet sistemi bağlanabilen alıcı  <i>MO715- receiver available to connect button-photocell-pneumatic safety system</i>		RC.MOT.715.ZER
	MO715-ZER tek kanallı verici  <i>MO715-ZER 1 channel transmitter</i>		RC.SKR.715.01C
	MO715-ZER 2 kanallı verici  <i>MO715-ZER 2 channels transmitter</i>		RC.SKR.715.04C
	MO715-ZER 4 kanallı verici  <i>MO715-ZER 4 channels transmitter</i>		RC.SKR.715.02C

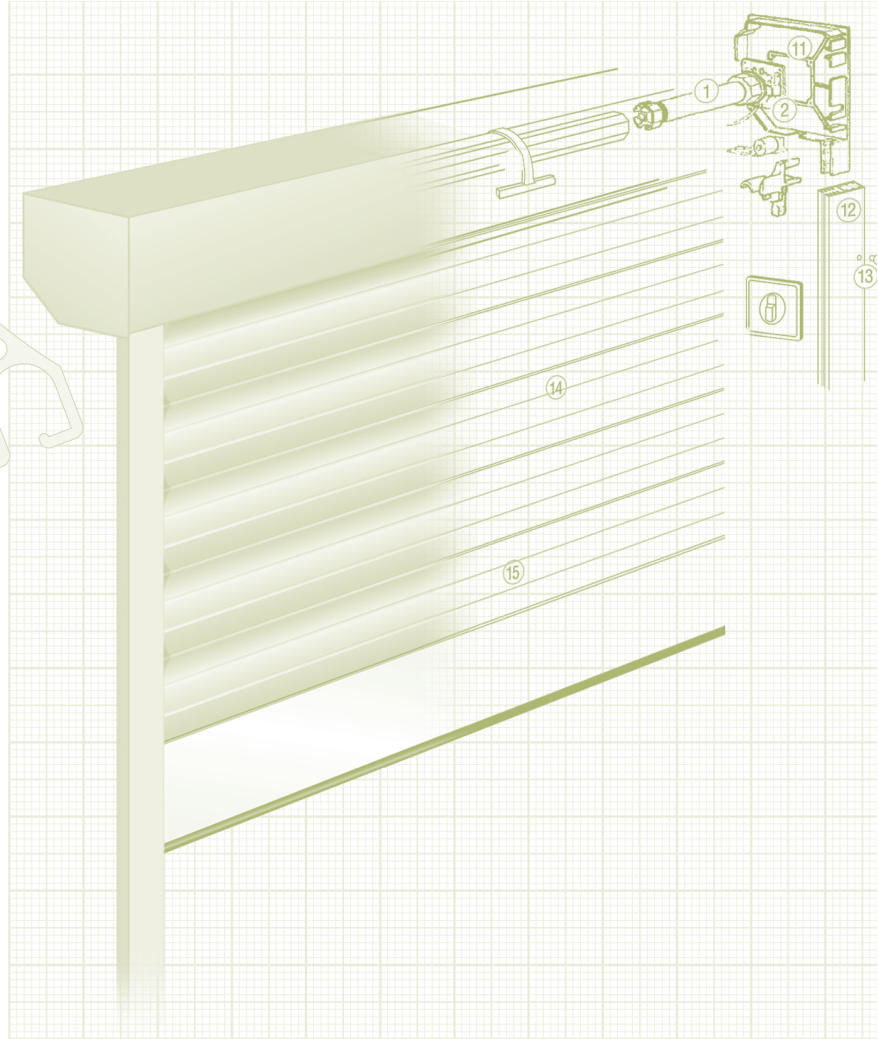

**Mosel Uzaktan Kumanda Sistemleri**  
***Mosel Power Remote Control Systems***





- 1
- 2
- 3
- 4
- 5
- 6
- 7
- 8
- 9
- 10
- 11
- 12
- 13
- 14
- 15
- 16
- 17
- 18
- 19
- 20
- 21
- 22
- 23
- 24
- 25
- 26
- 27
- 28
- 29

ÜRÜN ITEM	ÜRÜN ÖZELLİKLERİ PRODUCT DESCRIPTION	ÜRÜN KODU CODE
	Mosel Power Radyo Alıcı -DC155 (Alıcı + 2 adet verici dahil) <i>Mosel power radio receiver-DC155 (Receiver + 2 pcs. transmitter included)</i>	RC.POW.AL.01
	Mosel Power Radyo Alıcı-DC257 (Alıcı + 2 adet verici dahil) <i>Mosel power radio receiver-DC257 (Receiver + 2 pcs. transmitter included)</i>	RC.POW.AL.04
	İki kanallı verici (manuel şifrelendirilen) <i>2 Channel transmitter (manuel encoded)</i>	RC.POW.TV.01
	Dört kanallı verici (manuel şifrelendirilen) <i>4 Channel transmitter (manuel encoded)</i>	RC.POW.TV.04





ÜRÜN ITEM	ÜRÜN ÖZELLİKLERİ PRODUCT DESCRIPTION	ÜRÜN KODU CODE
	MOSEL Karre tek kanallı duvar tipi verici <i>MOSEL Karre single channel transmitter</i>	RC.OTM.DC.229
	MOSEL Karre iki kanallı duvar tipi verici <i>MOSEL Karre two channels transmitter</i>	RC.OTM.DC.230
	MOSEL DC-74 Su geçirmez, panjur-perde alıcı kutu içi monte edilebilir <i>MOSEL DC-74 water resistant receiver available to fix in the box</i>	RC.ALC.DC.074
	MOSEL DC-73A Su geçirmez, panjur-perde alıcı kutu içi monte edilebilir <i>MOSEL DC-73A water resistant receiver available to fix in the box</i>	RC.ALC.DC.73A
	MOSEL DC-269 SEL-60 motor panjur-perde alıcı kutu içi monte edilebilir <i>MOSEL-DC-269 receiver for SEL-60 motors available to fix in the box</i>	RC.ALC.DC.269
	MOSEL POWER DC 278 Su geçirmez alıcı (vericisiz) <i>MOSEL POWER DC 278 water resistant receiver(without transmitter)</i>	RC.OTM.DC.278



ÜRÜN ITEM	ÜRÜN ÖZELLİKLERİ PRODUCT DESCRIPTION	ÜRÜN KODU CODE
	MOSEL elektronik motor tekli verici <i>MOSEL single channel transmitter for electronic motor</i>	RC.OTM.DC.90
	MOSEL elektronik motor 5 kanallı verici <i>MOSEL 5 channels transmitter for electronic motor</i>	RC.OTM.DC.92
	MOSEL elektronik motor 8+1 LCD verici <i>MOSEL 8+1 LCD transmitter for electronic motor</i>	RC.OTM.DC.93
	MOSEL elektronik motor 14+1 LCD verici <i>MOSEL 14+1 LCD transmitter for electronic motor</i>	RC.OTM.DC.94

ÜRÜN ITEM	ÜRÜN ÖZELLİKLERİ PRODUCT DESCRIPTION	ÜRÜN KODU CODE
	MOSEL elektronik motor tekli verici <i>MOSEL single transmitter for electronic motor</i>	RC.OTM.DC.104
	MOSEL elektronik motor 5 kanallı verici <i>MOSEL 5 channels transmitter for electronic motor</i>	RC.OTM.DC.105
	MOSEL elektronik motor 8+1 LCD verici <i>MOSEL 8+1 LCD transmitter for electronic motor</i>	RC.OTM.DC.106

ÜRÜN ITEM	ÜRÜN ÖZELLİKLERİ PRODUCT DESCRIPTION	ÜRÜN KODU CODE
	MOSEL elektronik motor 14+1 LCD verici <i>MOSEL 14+1 LCD transmitter for electronic motor</i>	RC.OTM.DC.107
	MOSEL elektronik motor LCD tekli verici- zaman ayarlı <i>MOSEL LCD single transmitter for electronic motor - with timer</i>	RC.OTM.DC.168
	MOSEL elektronik motor 14+1 LCD verici- zaman ayarlı <i>MOSEL 14+1 LCD transmitter for electronic motor - with timer</i>	RC.OTM.DC.169

ÜRÜN ITEM	ÜRÜN ÖZELLİKLERİ PRODUCT DESCRIPTION	ÜRÜN KODU CODE
	MOSEL Silver elektronik motor tekli verici <i>MOSEL Silver single channel transmitter for electronic motor</i>	RC.OTM.DC.305
	MOSEL Silver elektronik motor 5 kanallı verici <i>MOSEL Silver 5 channels transmitter for electronic motor</i>	RC.OTM.DC.306
	MOSEL Silver elektronik motor 8+1 LCD verici <i>MOSEL Silver 8+1 channels LCD transmitter for electronic motor</i>	RC.OTM.DC.307
	MOSEL Silver elektronik motor 14+1 LCD verici <i>MOSEL Silver 14+1 channels LCD transmitter for electronic motor</i>	RC.OTM.DC.313
	MOSEL Santral ünitesi 1 buton ile 4 motor kontrol edilir <i>MOSEL Central unit-available to operate 4 motors by1 button</i>	RC.OTM.DC.80





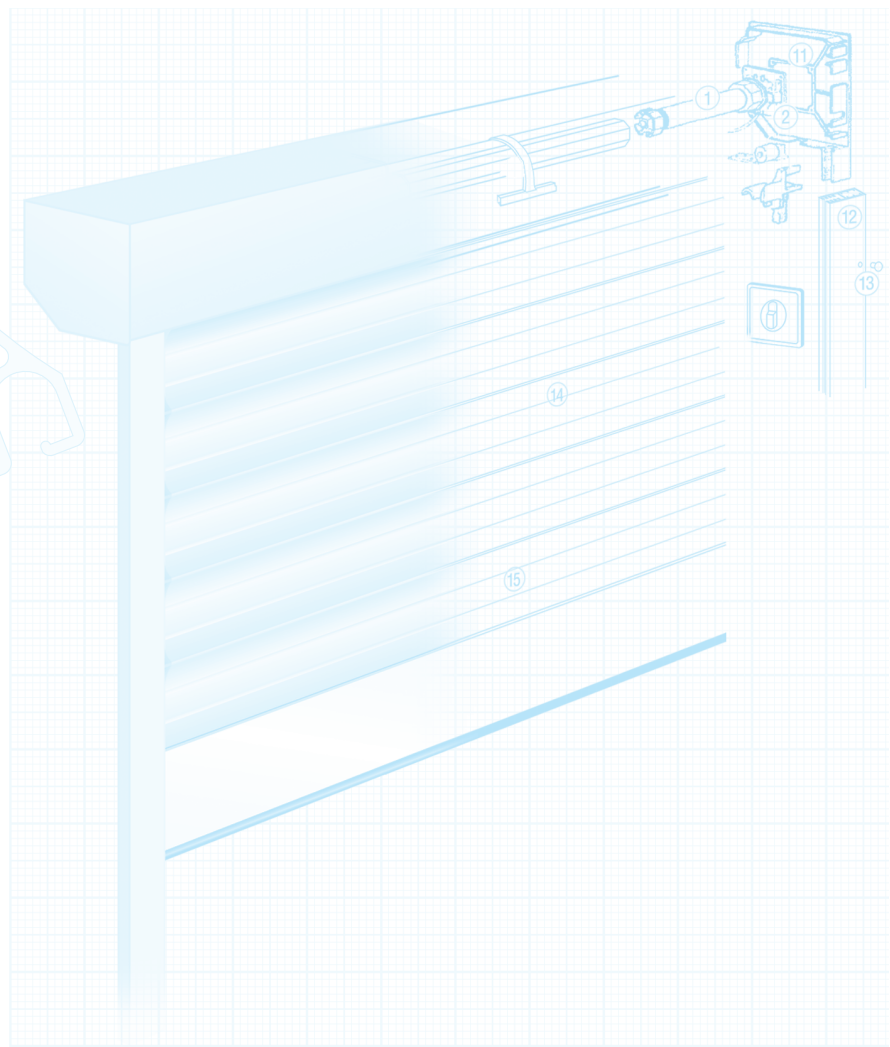

**Timmer Emniyet Fren Sistemleri**  
***Timmer Safety Brake Systems***

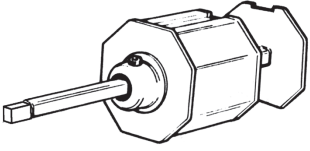

- 1
- 2
- 3
- 4
- 5
- 6
- 7
- 8
- 9
- 10
- 11
- 12
- 13
- 14
- 15
- 16
- 17
- 18
- 19
- 20
- 21
- 22
- 23
- 24
- 25
- 26
- 27
- 28
- 29

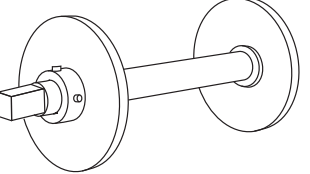
**EMNİYET FREN SİSTEMLERİ-garaj kapısı-kepenk-endüstriyel kapılar**  
**SAFETY BRAKE SYSTEMS-garage doors-roller shutters-industrial doors**

ÜRÜN ITEM	ÜRÜN ÖZELLİKLERİ PRODUCT DESCRIPTION	RENK COLOR	ÜRÜN KODU CODE
	<p>TIMMER-EN 13241-1-TA 0-RD/X Standart-95 Nm-□18x18 mm emniyet freni</p> <p><i>TIMMER-EN 13241-1-TA 0-RD/X Standard-95 Nm-□18x18 mm safety brake</i></p>		TA.ORD.00.907
	<p>Ø70 Uzatmalı boru başı-□18x18 mm- TA-0-RD/x uyumlu</p> <p><i>Ø70 Adjustable cap-□18x18 mm- appropriate to TA-0-RD/x</i></p>		CP.ORD.70.907
	<p>TIMMER-EN 13241-1-Ta 0-RD/X Standart-147 Nm-□18x18 mm emniyet freni</p> <p><i>TIMMER-EN 13241-1-Ta 0-RD/X Standard-147 Nm-□18x18 mm safety brake</i></p>		TA.ORD.00.403
	<p>Ø102 Uzatmalı boru başı-□18x18 mm- Ta 0-RD/X Standart-uyumlu</p> <p><i>Ø102 Adjustable cap -□18x18 mm- appropriate to Ta 0-RD/X Standard</i></p>		CP.ORD.70.403
	<p>TIMMER-EN 13241-1 Standard-907 ve 403 model kablosu</p> <p><i>TIMMER-EN 13241-1 Standard-907 and 403 model's cable</i></p>		TA.SWC.01.923

**EMNİYET FREN SİSTEMLERİ-garaj kapısı-kepenk-endüstriyel kapılar**  
**SAFETY BRAKE SYSTEMS-garage doors-roller shutters-industrial doors**

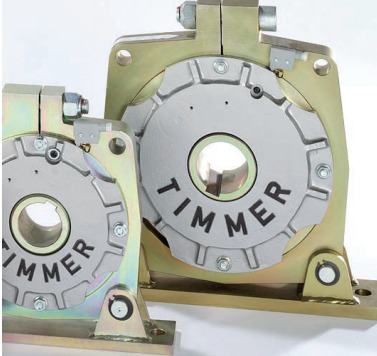
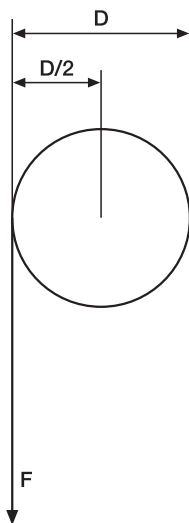
ÜRÜN ITEM	ÜRÜN ÖZELLİKLERİ PRODUCT DESCRIPTION	RENK COLOR	ÜRÜN KODU CODE
	TIMMER-EN 13241-1-TA 1/2 RD Standart-332 Nm-Ø35 mm emniyet freni <i>TIMMER-EN 13241-1-TA 1/2 RD</i> <i>Standard-332 Nm-Ø35 mm</i> <i>safety brake</i>		TA.12R.01.129
	TIMMER-EN 13241-1-TA 2/3 RDStandart-552 Nm-Ø40 mm emniyet freni <i>TIMMER-EN 13241-1-TA 2/3</i> <i>RDStandart-552 Nm-Ø40 mm</i> <i>safety brake</i>		TA.23R.01.238
	TIMMER-EN 13241-1-TA 3-RD Standart-599 Nm-Ø40 mm emniyet freni <i>TIMMER-EN 13241-1-TA 3-RD</i> <i>Standard-599 Nm-Ø40 mm</i> <i>safety brake</i>		TA.3RD.01.312
	TIMMER-EN 13241-1-TA 4-RD Standart-1063 Nm-Ø50 mm emniyet freni <i>TIMMER-EN 13241-1-TA 4-RD</i> <i>Standard-1063 Nm-Ø50 mm</i> <i>safety brake</i>		TA.4RD.01.402
	TIMMER-EN 13241-1-TA-5 RD Standart-1943 Nm-Ø60 mm emniyet freni <i>TIMMER-EN 13241-1-TA-5 RD</i> <i>Standard-1943 Nm-Ø60 mm</i> <i>safety brake</i>		TA.5RD.01.504
	<p><b>Faustformel zur Berechnung des max. Dehmoments an Rolltoren</b></p> <p><b>Mmax = (D/2 + 10%) x F</b></p> <p>z.B.            F = 100 Kg = 1000 N            D = 100 mm = 0,1 m</p> <p>➔ Mmax = (0,1m/2 + 10%) x 1000N            = 0,055m x 1000N            = 55Nm</p>		





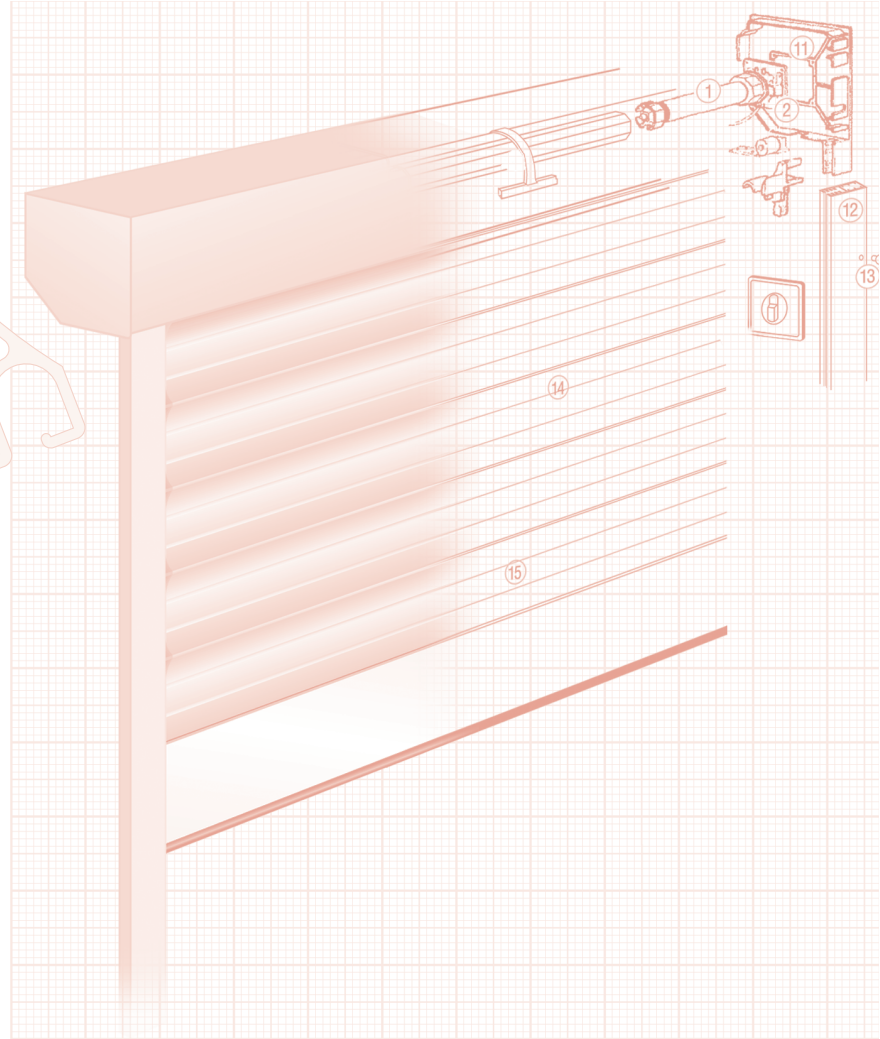

**Galvanizli Çelik Kepenk-Kapı Profilleri**  
***Galvanised Steel Rolling-Door Motors***



- 1
- 2
- 3
- 4
- 5
- 6
- 7
- 8
- 9
- 10
- 11
- 12
- 13
- 14
- 15
- 16
- 17
- 18
- 19
- 20
- 21
- 22
- 23
- 24
- 25
- 26
- 27
- 28
- 29

**GALVANİZLİ ÇELİK KEPENK-KAPI PROFİLLERİ**  
**GALVANISED STEEL ROLLING SHUTTER- DOOR PROFILES**

ÜRÜN ITEM	KALINLIK THICKNESS	KAPAMA YÜZEYİ SURFACE AREA	AĞIRLIK WEIGHT	m <sup>2</sup> AĞIRLIK WEIGHT	ÜRÜN KODU CODE
	<b>SET-75</b> <b>GALVANİZLİ ÇELİK PROFİL</b> <b>GALVANISED STEEL PROFILES</b>				
	0.70 mm	75 mm	~0.720 Kg.	~9.60 Kg.	SET 075.KA.070
	0.80 mm	75 mm	~0.865 Kg.	~11.53 Kg.	SET 075.KA.080
	1.00 mm	75 mm	~1.077 Kg.	~14.36 Kg.	SET 075.KA.100
	1.20 mm	75 mm	~1.292 Kg.	~17.22 Kg.	SET 075.KA.120
	<b>SET-115</b> <b>GALVANİZLİ ÇELİK PROFİL</b> <b>GALVANISED STEEL PROFILES</b>				
	0.80 mm	115 mm	~1.135 Kg.	~9.87 Kg.	SET 115.KA.080
	1.00 mm	115 mm	~1.415 Kg.	~12.31 Kg.	SET 115.KA.100
	1.20 mm	115 mm	~1.695 Kg.	~14.75 Kg.	SET 115.KA.120
	<b>SET-100</b> <b>GALVANİZLİ ÇELİK PROFİL</b> <b>GALVANISED STEEL PROFILES</b>				
	1,00 mm	100 mm	~1,570 Kg.	~15,70 Kg.	SET.100.KA.100
	1,20 mm	100 mm	~1,875 Kg.	~18,75 Kg.	SET.100.KA.120
	<b>SET-120</b> <b>GALVANİZLİ ÇELİK PROFİL</b> <b>GALVANISED STEEL PROFILES</b>				
	0.80 mm	110 mm	~1.135 Kg.	~9.45 Kg.	SET 120.KA.080
	1.00 mm	110 mm	~1.415 Kg.	~11.79 Kg.	SET 120.KA.100
	1.20 mm	110 mm	~1.695 Kg.	~14.12 Kg.	SET 120.KA.120

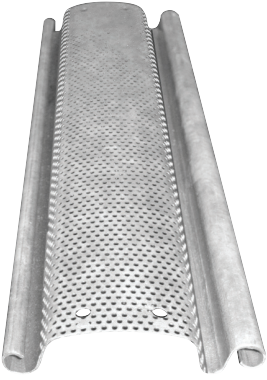
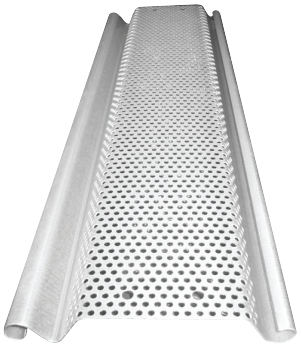
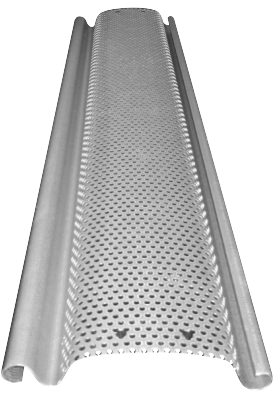
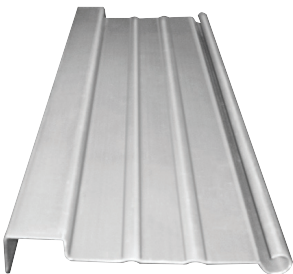

**MİKRO DELİKLİ, GALVANİZLİ ÇELİK KEPENK-KAPI PROFİLLERİ**  
**GALVANISED STEEL PROFILES WITH MICRO HOLES**

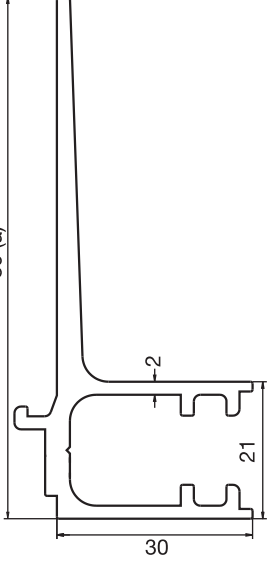
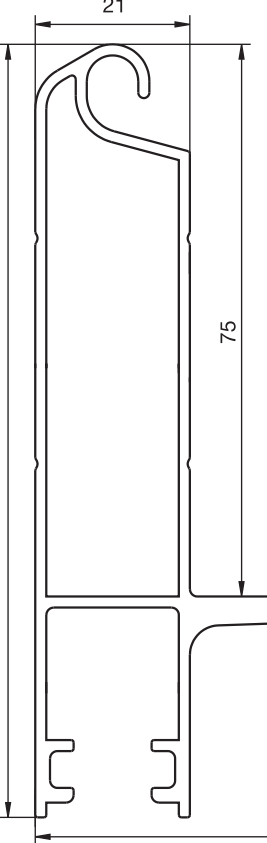
ÜRÜN ITEM	KALINLIK THICKNESS	KAPAMA YÜZEYİ SURFACE AREA	AĞIRLIK WEIGHT	m <sup>2</sup> AĞIRLIK WEIGHT	ÜRÜN KODU CODE
	<b>SET-75</b> <b>MİKRO DELİKLİ GALVANİZLİ ÇELİK PROFİL</b> <b>GALVANISED STEEL PROFILES WITH MICRO HOLES</b>				
	0.70 mm	75 mm	~ 0.600 Kg.	~ 8.00 Kg.	SET 075.DE.070
	0.80 mm	75 mm	~ 0.720 Kg.	~ 9.60 Kg.	SET 075.DE.080
	1.00 mm	75 mm	~ 0.905 Kg.	~ 12.06 Kg.	SET 075.DE.100
	<b>SET-115</b> <b>MİKRO DELİKLİ GALVANİZLİ ÇELİK PROFİL</b> <b>GALVANISED STEEL PROFILES WITH MICRO HOLES</b>				
	0.80 mm	115 mm	~ 0.960 Kg.	~ 8.35 Kg.	SET 115.DE.080
	1.00 mm	115 mm	~ 1.201 Kg.	~ 10.45 Kg.	SET 115.DE.100
	<b>SET-120</b> <b>MİKRO DELİKLİ GALVANİZLİ ÇELİK PROFİL</b> <b>GALVANISED STEEL PROFILES WITH MICRO HOLES</b>				
	0.80 mm	110 mm	~ 0.960 Kg.	~ 8.35 Kg.	SET 120.DE.080
	1.00 mm	110 mm	~ 1.201 Kg.	~ 10.45 Kg.	SET 120.DE.100
	<b>SET-130</b> Galvanizli çelik alt parça <i>Galvanised steel end slat</i>				SET.130.AP.120

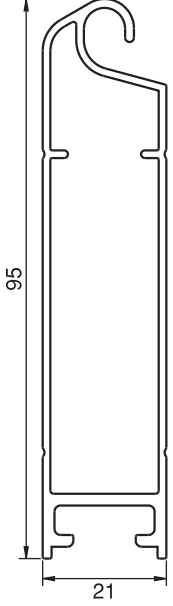
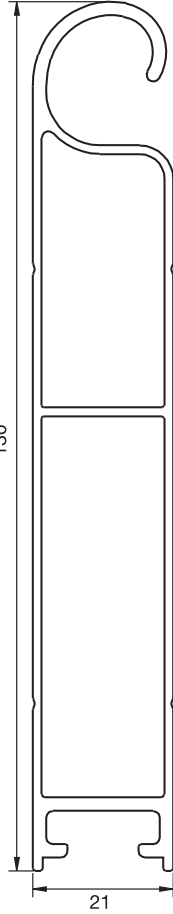
ÜRÜN İTEM	ÜRÜN ÖZELLİKLERİ PRODUCT DESCRIPTION	RENK COLOR	ÜRÜN KODU CODE
	<p>Galvaniz profil için alüminyum alt parça prf. (ES.409..., ES.371..., ES.133...) alt parça ile uyumlu</p> <p><i>Aluminium end slat for galvanized profile appropriate to (ES.409..., ES.371..., ES.133...)</i></p>	PRES	ES.410.00SET
	<p>Galvaniz profil için alüminyum köşebentli parça</p> <p><i>Aluminium gusset for galvanized profile.</i></p>	PRES	ES.405.00.SET

ÜRÜN İTEM	ÜRÜN ÖZELLİKLERİ PRODUCT DESCRIPTION	RENK COLOR	ÜRÜN KODU CODE
	<p>Galvaniz profil için alüminyum alt parça prf. (ES.410...) alt parça ile uyumlu</p> <p><i>Aluminium end slat for galvanized profile appropriate to (ES.410...)</i></p>	PRES	ES.409.00.SET
	<p>SET-100 Galvaniz Profil için Alüminyum Alt Parça Profili (ES.410....) uyumlu</p> <p><i>Aluminium end slat for SET-100 galvanized profile appropriate to (ES.410....)</i></p>	PRES	ES.371.00.SET

**KEPENK-KAPI AKSESUARLARI**  
**ROLLING SHUTTER- DOOR ACCESSORIES**

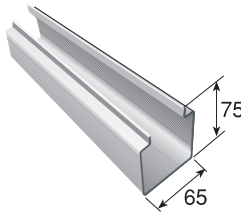
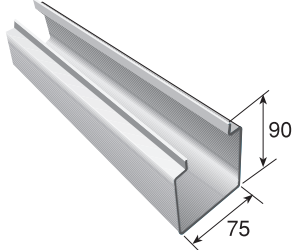
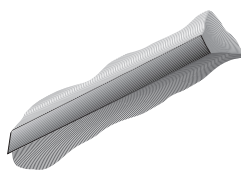
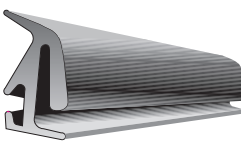





ÜRÜN ITEM	ÜRÜN ÖZELLİKLERİ PRODUCT DESCRIPTION	ÜRÜN KODU CODE
	Alt parça lastik C Profili (SET.130.AP.120 için) <i>Nylon end slat C Profile (for SET.130.AP.120)</i>	SET.130.AP.DST
	Alt Parça Lastik Fitili (SET.130.AP.DST için) <i>End slat nylon stripe (for SET.130.AP.DST)</i>	ALF.000.00.000
	Galvanizli Sac U Profili (standart) <i>Galvanised steel entry guide (standard)</i>	SET.075.DU.200
	Galvanizli Sac U Profili (geniş) <i>Galvanised steel entry guide (large)</i>	SET.090.DU.200
	Kıl Fitil (lastik fitile uyumlu, 1200'lük) <i>Brush insert (compatible with nylon stripe, 1200)</i> Kıl Fitil (lastik fitile uyumlu, 1800'lük) <i>Brush insert (compatible with nylon stripe, 1800)</i>	GC.120.00.INS GC.180.00.INS
	U Profil Lastik Fitili (kıl fitile uyumlu) <i>Entry guide nylon stripe (compatible with brush insert)</i>	ULF.LST.FT.000

**KEPENK-KAPI AKSESUARLARI**  
**ROLLING SHUTTER- DOOR ACCESSORIES**

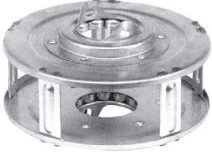

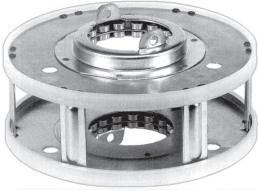
<b>ÜRÜN ITEM</b>	<b>ÜRÜN ÖZELLİKLERİ PRODUCT DESCRIPTION</b>	<b>ÜRÜN KODU CODE</b>
	SET-75 Profil Tapası <i>PVC cap for SET-75 profiles</i>	SET.075.TA.010
	SET-115 Profil Tapası <i>PVC cap for SET-115 profiles</i>	SET.115.TA.010
	SET-120 Profil Tapası <i>PVC cap for SET-120 profiles</i>	SET.120.TA.010
	SET-100 Profil Tapası (metal) <i>Metal cap for SET-100 profiles</i>	SET.100.TA.010
	76 mm. Boru <i>76 mm. Tube</i>	BOR.GAL.76.000
	60 mm. Boru <i>60 mm. Tube</i>	BOR.GAL.60.000
	Boru yatak bağlaması (boğaz) <i>Universal galvanised support for shaft 60 mm - 76 mm</i>	BYB.BOG.00.19Z
	Yatak bağlama vidası ve somunu <i>Universal support fixing bolts</i>	BYB.SVI.00.20Z



**KEPENK-KAPI AKSESUARLARI**  
**ROLLING SHUTTER- DOOR ACCESSORIES**

ÜRÜN ITEM	ÜRÜN ÖZELLİKLERİ PRODUCT DESCRIPTION		ÜRÜN KODU CODE
	Yay Kutusu (yay taşı) <i>Spring box</i>	220 x 60 x 60 220 x 60 x 50 200 x 60 x 60 200 x 60 x 50	YKU.220.60.060 YKU.220.60.050 YKU.200.60.060 YKU.200.60.050
	Yay Kutu Lastiği <i>Nylon cover ring for spring boxes</i>		YKL.003.20.000 YKL.003.22.000
	Yay Kutusu (yay taşı) <i>Spring box</i>	240 x 76 x 60	YKU.240.76.060
	Yay Kutu Lastiği <i>Nylon cover ring for spring boxes</i>		YKL.003.24.000
	Kepenک yayı <i>Steel spring</i>	yay 45 x 1.2 yay 45 x 1.4 yay 50 x 1.3 yay 55 x 1.4 yay 60 x 1.2 yay 60 x 1.4	Ağırlık/m 0.42 0.49 0.51 0.60 0.57 0.66
	Profil Askı Kancası 60 mm. yay <i>Connecting hook for boxes for 60 mm. spring</i>		ASK.KAN.60.4S3

**KEPENK-KAPI AKSESUARLARI**  
**ROLLING SHUTTER- DOOR ACCESSORIES**

<b>ÜRÜN ITEM</b>	<b>ÜRÜN ÖZELLİKLERİ PRODUCT DESCRIPTION</b>	<b>ÜRÜN KODU CODE</b>
	Alt parça kepenk kilidi <i>Central multileverlock for rolling shutter bended bars</i>	SKK.017.SD.9CO
	Alt parça kepenk kulpu <i>Handle for rolling shutter bended bars</i>	APK.KUL.00.000
	Dış manuel fren kutusu <i>External manual brake box</i>	MO.ECE.EX.FRE



## Profiller Hakkında Bilgiler

### *Information on Slats*

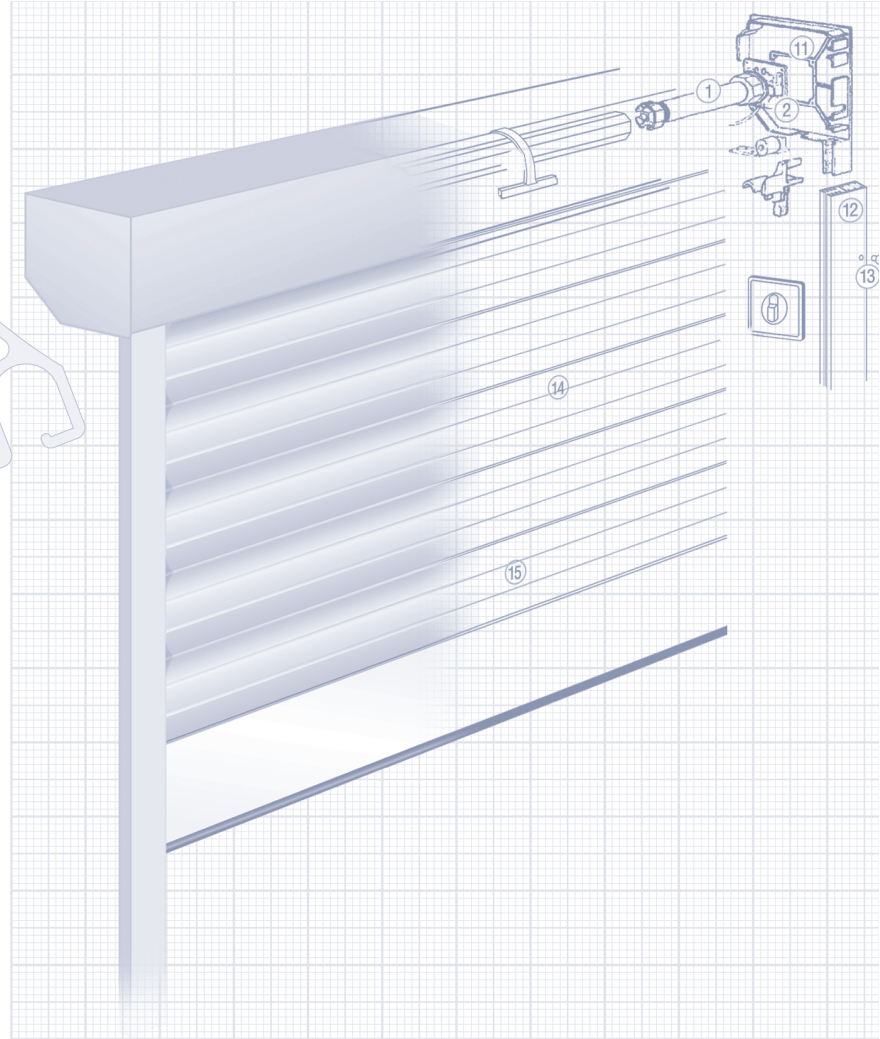

- 1
- 2
- 3
- 4
- 5
- 6
- 7
- 8
- 9
- 10
- 11
- 12
- 13
- 14
- 15
- 16
- 17
- 18
- 19
- 20
- 21
- 22
- 23
- 24
- 25
- 26
- 27
- 28
- 29

## **PROFİLLER HAKKINDA BİLGİLER**

### ***INFORMATION ON SLATS***

**HAVALANDIRMA DELİKLERİ**  
**VENTILATION HOLES**

SL-39, SL-41, SL-45	1.3 mm	1.2 mm	37.5 mm
SL-55, SL-56	1.8 mm	16 mm	37.5 mm

